

Synthese Library 447

Studies in Epistemology, Logic, Methodology,
and Philosophy of Science

Gustavo E. Romero

Javier Pérez-Jara

Lino Camprubí *Editors*

Contemporary Materialism: Its Ontology and Epistemology



Springer

Synthese Library

Studies in Epistemology, Logic, Methodology, and Philosophy
of Science

Volume 447

Editor-in-Chief

Otávio Bueno, Department of Philosophy, University of Miami, Coral Gables, USA

Editorial Board Members

Berit Brogaard, University of Miami, Coral Gables, USA

Anjan Chakravartty, Department of Philosophy, University of Miami, Coral Gables,
FL, USA

Steven French, University of Leeds, Leeds, UK

Catarina Dutilh Novaes, VU Amsterdam, Amsterdam, The Netherlands

Darrell P. Rowbottom, Department of Philosophy, Lingnan University, Tuen Mun,
Hong Kong

Emma Ruttkamp, Department of Philosophy, University of South Africa, Pretoria,
South Africa

Kristie Miller, Department of Philosophy, Centre for Time, University of Sydney,
Sydney, Australia

The aim of *Synthese Library* is to provide a forum for the best current work in the methodology and philosophy of science and in epistemology, all broadly understood. A wide variety of different approaches have traditionally been represented in the Library, and every effort is made to maintain this variety, not for its own sake, but because we believe that there are many fruitful and illuminating approaches to the philosophy of science and related disciplines.

Special attention is paid to methodological studies which illustrate the interplay of empirical and philosophical viewpoints and to contributions to the formal (logical, set-theoretical, mathematical, information-theoretical, decision-theoretical, etc.) methodology of empirical sciences. Likewise, the applications of logical methods to epistemology as well as philosophically and methodologically relevant studies in logic are strongly encouraged. The emphasis on logic will be tempered by interest in the psychological, historical, and sociological aspects of science.

In addition to monographs *Synthese Library* publishes thematically unified anthologies and edited volumes with a well-defined topical focus inside the aim and scope of the book series. The contributions in the volumes are expected to be focused and structurally organized in accordance with the central theme(s), and should be tied together by an extensive editorial introduction or set of introductions if the volume is divided into parts. An extensive bibliography and index are mandatory.

Gustavo E. Romero • Javier Pérez-Jara •
Lino Camprubí
Editors

Contemporary Materialism: Its Ontology and Epistemology

 Springer

Editors

Gustavo E. Romero
Instituto Argentino de Radioastronomía
(IAR) (CONICET; CICPBA; UNLP)
Villa Elisa, Buenos Aires, Argentina

Facultad de Ciencias Astronómicas y
Geofísicas
Universidad Nacional de La Plata
La Plata, Provincia de Buenos Aires
Argentina

Lino Camprubí
Departamento de Lógica y Filosofía de la
Ciencia
Universidad de Sevilla
Sevilla, Spain

Javier Pérez-Jara
International Business School
Beijing Foreign Studies University
Beijing, China

Center for Cultural Sociology
Yale University
New Haven, CT, USA

ISSN 0166-6991

Synthese Library

ISBN 978-3-030-89487-0

<https://doi.org/10.1007/978-3-030-89488-7>

ISSN 2542-8292 (electronic)

ISBN 978-3-030-89488-7 (eBook)

© Springer Nature Switzerland AG 2022

This work is subject to copyright. All rights are reserved by the Publisher, whether the whole or part of the material is concerned, specifically the rights of translation, reprinting, reuse of illustrations, recitation, broadcasting, reproduction on microfilms or in any other physical way, and transmission or information storage and retrieval, electronic adaptation, computer software, or by similar or dissimilar methodology now known or hereafter developed.

The use of general descriptive names, registered names, trademarks, service marks, etc. in this publication does not imply, even in the absence of a specific statement, that such names are exempt from the relevant protective laws and regulations and therefore free for general use.

The publisher, the authors, and the editors are safe to assume that the advice and information in this book are believed to be true and accurate at the date of publication. Neither the publisher nor the authors or the editors give a warranty, expressed or implied, with respect to the material contained herein or for any errors or omissions that may have been made. The publisher remains neutral with regard to jurisdictional claims in published maps and institutional affiliations.

This Springer imprint is published by the registered company Springer Nature Switzerland AG.
The registered company address is: Gewerbestrasse 11, 6330 Cham, Switzerland

*To the memory of Mario Bunge (1919–2020).
Philosopher, teacher, friend.*

Foreword

Materialism is a word that arouses many emotions. It was a swearword, pertaining to the shallow way of life of caring for material wealth alone. Like many other words, it became a praise word, designating disregard for hot air and taking every discussion rapidly to brass tacks. On a more abstract level, it is the doctrine that there is no life after death and the subsequent recommendation to seize the day. On a still more abstract level, materialism is the idea that the universe is self-contained and houses no spirits.

Of the teaching of the first philosopher, Thales of Miletus, what has survived is that all is water—meaning the world is one substance with many appearances. This theory is central to all western philosophy; it is its best characteristic. The Aristotelian theory of the four elements is thus incomplete without the idea that they are all manifestation of one substance, the *hyle*, the primordial formless matter. Hence, comparing the four Greek elements with the Chinese five is an error.

The doctrine of the substance is problematic. Modern physicist, from Galileo and Newton to Kelvin and Maxwell and Mach, vainly tried to eliminate force from basic physics as fictitious. Similarly, Émile Meyerson deemed energy fictitious. Einstein's equation of mass with energy was hard to stomach since it deeply affected the idea of substance. Newton and his followers equated mass with matter as substance. Commentators wondered why he took the trouble to word his first law that follows from his second law. The answer is that he took the first law as substantial and the second as transitory. Oddly, general relativity may be a new version of Newton's first law that embodies the second law. Except that Einstein had no use for substance. His metaphysics was, *natural laws are partial differential equations indifferent to some laws of transformation*. This is more remote from ancient Greek philosophy than any part of classical physics except for the second law of thermodynamics that stands apart.

There were other, harder troubles with substances: as they are unchangeable, they cannot interact. Mind and matter interact nonetheless. This is a serious impediment, known as the mind-body problem. The abolition of substance removed it and rendered the problem manageable. Indeed, the demise of the substance leaves no problem and no theory unchanged. They are all in need of restatements. Materialism

no longer means a one-substance theory, a rival to idealism. Does it now refer to basic elementary particles? Do all the different elementary particles comprise one substance or more? They hardly matter for the theory of the brain, as biochemistry should suffice for that. Now does the theory of the matter of the brain suffice? Are nerve systems merely chemicals or structured chemical as systemists would have it? It is no accident that Mario Bunge plays a significant role in this volume, as he is the arch-advocate of systemism. Is systemism a new form of materialism or a new philosophy altogether? I invite you to find answers in this interesting and timely volume.

Herzlia, Israel
April 29, 2020

Jospeh Agassi

Preface

What is materialism and what can it offer today? This book aims at showing that materialism is much more than physicalism and that philosophical approaches to materialism can redirect current discussions on ontology and epistemology. To be up to the task, however, philosophical materialism needs to be aware of both up-to-date scientific results and the subtleties of the philosophical tradition.

We aim to explore fresh understandings of *matter* and our knowledge of it, which are well-informed not only by current physics but also by natural, social, and biosocial sciences. Thus, the book's chapters delve on quantum matter, spacetime, living matter, the mind, mathematics, and logic, among others. Our goal is also to strengthen the role of philosophical materialism in the interpretation of the history of philosophical ideas. Several of the book's chapters do that work aiming at novel and penetrating revisions. The result, we hope, will show that philosophical materialism, being well alive, stimulates further research and discussions in current ontological and epistemological issues.

The path to this book started at a discussion table on the relationships among science, philosophy, and ideology organized by one of us (Lino Camprubí) at the University of Barcelona, where the other two (Gustavo E. Romero and Javier Pérez-Jara) were paying academic visits. We are thankful for the UB's hospitality as well as for that of Xavier Roqué and José Romo. After drafting the book's main topics, we contacted some of the colleagues whom we thought could provide fresh outlooks. Our deepest gratitude goes of course to the authors of the chapters and discussions for their good work and their willingness to discuss their drafts with us, sometimes to minute details. Some of those who accepted to participate at first could not continue, but we thank them for their initial enthusiasm, which helped keeping ours high.

From the onset, we got a very positive response from Otavio Bueno, editor of the Springer Synthese Library. He was instrumental in making us put all of this together in due time and shape. A second meeting between the editors at the University of Seville, which hosted us for 3 days, gave the final shape to the book proposal as well as to the historical chapter with which we open the book after the Introduction. We thus thank the Department of Logic and Philosophy of

Science there, and in particular José Ferreirós. During writing, Javier Pérez-Jara was a visiting scholar at Stanford University's Department of Religious Studies and Kyoto Sangyo University's Department of Sociology, and he would like to thank, respectively, Thomas Sheehan, Fujino Atsuko, Ito Kimio, Piya Tom, and Nohara Jun for their support and feedback on his research. He also thanks Song Zening, Niu Huayong, and Qin Chuan at Beijing Foreign Studies University's International Business School for their support and guidance from the beginning of this project. Gustavo E. Romero thanks the National University of La Plata, the Karlsruhe Institute of Technology (KIT), the University of Barcelona, the University of Seville, and the Institute of Cosmos Sciences (ICCUB), University of Barcelona, for hospitality and support at different stages of this project. He is also indebted to Mario Bunge for many discussions on the topic of this book and the nature of the quantum world. Finally, the editors also thank Jesús Ledo García for his expertise in computer science, which greatly helped us to compile the finished book in L^AT_EX.

During the preparation of this book, Mario Bunge, one of the leading materialist philosophers of the twentieth century and part of this century passed away. He was 100 years old. We want to dedicate this volume to his memory.

La Plata, Argentina
Beijing, China
Sevilla, Spain
April 2020

Gustavo E. Romero
Javier Pérez-Jara
Lino Camprubí

Introduction

Materialism has been the subject of extensive and rich controversies since Robert Boyle introduced the term for the first time in the seventeenth century. There is an observable, clearly false consensus among many people, including some philosophers, according to which the meaning of materialism is transparent. Nevertheless, when we pay carefully attention, the first fact that comes into attention is that materialism's meaning is mainly divided into two different senses. On the one hand, in the popular (i.e., not philosophical) understanding, materialism is associated with all kind of moral, sociocultural, economic, and even political vices linked to the unrestricted pursuit of pleasure and “material” possessions. This popular moral meaning associated with materialism seems heavily supported on a dualist metaphysics in which the worst human vices (hedonism, selfishness, greed, lack of meaningful life) come from *matter*, whereas human virtues (temperance, altruism, solidarity, responsibility, meaningful existence) come from the realm of the *spirit*. This shows, among other things, that even popular moral and anthropological notions cannot escape from metaphysical commitments.

On the other hand, in its literal philosophical sense, materialism is usually defined as the worldview according to which everything real is material. The main issue here consists in that there is not enough philosophical consensus about whether the meaning of matter can be enlarged beyond the *physical*. As a consequence, the term materialism is often defined in stark exclusive and reductionist terms: whatever exists is either physical or ontologically reducible to it. This conception, if consistent, excludes the ontological significance of political, economic, socio-cultural, anthropological and psychological realities. Such metaphysical doctrine came to be known as *physicalism* in the twentieth century. Many philosophers (including us) strongly criticize physicalism because we understand that it heavily impoverishes the world and our knowledge of it. Therefore, this book's main approach moves away from the common but false dilemma between physicalism (which mutilates reality) and spiritualism/idealism (which unjustifiably hypostatizes what physicalism mutilates).

While ontological corporeism was the original meaning with which the term “materialism” entered into the philosophical vocabulary in the seventeenth cen-

tury, it has gone a long way from there. In the early nineteenth century, Fichte divided metaphysical views into two main families: materialism and idealism. But Fichte's notion of materialism was rather inclusive: it meant the general metaphysical doctrine according to which consciousness is derivative and totally dependent in respect of a lawful and impersonal reality, regardless of whether it is corporeal or not. While Fichte's conception of materialism was rather specific to his system of philosophy, the dichotomy between materialism and idealism soon caught up. Shortly, thanks to inclusive definitions of materialism such as Fichte's, many nineteenth-century thinkers (usually theologians and spiritualist philosophers) started to tag as materialist non-physicalist philosophies, such as those of Spinoza, Schopenhauer, and von Hartmann, among others. What is more, the strong division between materialism and idealism/spiritualism was applied retrospectively, for instance, to understand in what sense Pythagoras and Plato inaugurated objective idealism in the Western tradition, or how important ancient philosophers, from Confucius to many Presocratics, could be considered materialists.

In line with this historical transcendence, some of the more profound modern and contemporary philosophical disputes revolve around the significance of materialism and the positions of its detractors and defenders. In this way, materialism is usually regarded by its critics as the most superficial philosophical view, whereas it is distinguished by its supporters as the only *Weltanschauung* truly compatible with the development of science and critical thinking. At times, the differences within each of these groups are wider than those existing among them. And what is worse: the partial convergences between important materialist and idealist/spiritualist philosophies are often downplayed or even ignored in the name of a simplistic binary logic.

Where does the pervasive and controversial nature of materialism come from? Starting from a long and profound history of this worldview, the present book specifically focuses on the central ontological and epistemological debates aroused by today's leading materialist approaches, including some little-known to an anglophone readership. The volume discusses varieties of materialism and their connections to the sciences as well as their limitations. It does so not in the abstract but in the arena provided by a number of concrete big issues, ranging from the ontological structure of spacetime and quantum matter to the nature of the mind and the status of mathematical and logical entities. It has been designed and written to facilitate creative dialogue between different materialist approaches as well as idealists or non-materialist stances.

The chapters have been written by specialists selected because of their expertise in the different topics. This volume covers many of the most important ontological and epistemological issues of current materialism and it is particularly attentive to the philosophy of science and matter. A second volume will be a materialist intervention on pressing ethical, sociocultural, aesthetic, and political debates.

In Chap. 1, we, the editors, introduce a dual but complementary definition of materialism which we hope is general enough to both navigate historical discussions and become a useful tool for current open issues. First, in a negative way, all materialist philosophies deny the existence of disembodied living beings (for

instance: pure spirits) and hypostatized ideas (for instance: Platonic forms). Second, the most general positive thesis bringing materialists together is the identification of being with matter understood as changeability and plurality. We believe that stressing changeability and plurality is more encompassing than reducing matter in general to physical stuff, for there are, at least, chemical, biological, sociocultural, and artificial plural and changeable realities whose many qualitative properties are irreducible to the physical. Our long chapter on the history of materialism offers an ambitious history of scientific and philosophical theories of matter and materialist philosophies in the Western tradition. But it also argues that Platonism, Christian Scholastics, and German Idealism have had a more than significant role in the history of materialism. In our critiques of reductionist/exclusive materialism, the chapter also briefly discusses two important inclusive materialisms which we believe deserve a stronger presence in current anglophone debates about ontology and epistemology: the philosophies of Mario Bunge and Gustavo Bueno.

Chapter 2, by Gustavo E. Romero, is a presentation of systemic materialism, the ontological core of Mario Bunge's materialist philosophy. Romero summarizes and updates some of the main concepts of this system, including those of substance, system, natural law, emergence, level, mind, and value. Bunge's passing only a few months prior to the publication of the volume deeply saddened us. It was his purpose to write himself this chapter. That, alas, couldn't be. Romero tries in this chapter to honor his legacy in the way he liked most: questioning, challenging, developing, and updating his findings.

In Chap. 3, Javier Pérez-Jara does just that regarding the second of our inclusive materialists, Gustavo Bueno (1924–2016). Pérez-Jara presents Bueno's discontinuous materialism's main ontological and epistemological theses with an emphasis on drawing comparisons with other philosophical systems, specifically ontotheology, speculative realism, reductionist materialism, eliminative materialism, and systemic materialism. This analysis enables him to locate discontinuous materialism's strengths along with some of the main ontological and epistemological challenges and open issues it faces.

In Chap. 4, Gustavo E. Romero offers an updated and detailed materialist interpretation of quantum mechanics and field theory. Through an ontological and epistemological analysis of the building blocks of this science, Romero counters idealist and mentalist readings in order to develop the concept of quantum matter, proving that it is essential for a materialist ontology supported on science.

Continuing with the topic of physical matter, Luciano Combi explores space-time in Chap. 5. He argues that space-time is material, and therefore it interacts with other material entities and systems of the universe. After analyzing space-time and its properties, Combi discusses its relationships to physical matter and to a materialist understanding of energy and of current cosmology.

Chapter 6 moves the volume onto living matter. Rafael González del Solar mobilizes systemic materialism to argue that biology is not reducible to physics epistemologically nor ontologically. A pluralism of properties, he argues, enables for a materialist but not reductionist understanding of biosystems as forming an emergent new ontological level with respect to the physical one that supports it.

In Chap. 7, Íñigo Ongay takes us from physical and chemical matter to psychical matter in order to review the place of the mind in non-reductionist materialism. He analyzes many of the available responses to the so-called mind-body problem, gauging their respective strengths and weaknesses against current scientific findings in neurobiology but also in a number of animal and human sciences.

Chapter 8 is devoted to the epistemological and ontological implications of the material turn in the history of science. Materiality has received increasing attention by historians and philosophers of science, but also competing ontological interpretations. Lino Camprubí argues for a materialist ontology compatible with scientific development.

Chapter 9, by Carlos Madrid Casado, explores a materialist view of mathematics focused on mathematical practices and operations with symbols written in paper or otherwise. After classifying the available options regarding the role of signs in different branches of mathematics, Madrid Casado presents examples to support his view as well as its epistemological and ontological implications.

In Chap. 10, Miguel Ángel Quintanilla tackles the material nature of the virtual world of software. Through a systemic approach to technology—or, as he prefers, technique—Quintanilla analyzes the computational and electronic components of programs. Algorithms would not be mysterious immaterial entities, but have the same nature and properties as mathematical entities.

The book's final Chaps. 11, 12, and 13 are not devoted to conclusions but to discussions. This is our way of saying that our purpose is not to close the subject but to trigger productive conversations. With that in mind, we decided to pick some of the most salient disagreements within these book's chapters and initiate a dialogue between the authors. Six of the volume's authors engage in three different debates. In Chap. 11, Romero and Madrid Casado debate about mathematical reference. In Chap. 12, Ongay and Pérez-Jara examine the ontology of emergent materialism. Finally, in Chap. 13, Graham Harman, a well-known idealist philosopher, and Pérez-Jara discuss about materialism (its worth and its meanings). We proposed dichotomic formulations around each topic and asked the authors to defend a clear position in only a few pages. This format sacrifices nuances in favor of direct confrontation of clear theses and their foundations. It was a pleasant surprise to see deep connections between the three different discussions, so that the chapters maintain a thematic unity compiling some of the most intricate open problems of current philosophy in a way that allows readers to pick sides or, perhaps more likely, form their own opinion.

Contents

1	What is Materialism? History and Concepts	1
	Javier Pérez-Jara, Gustavo E. Romero, and Lino Camprubí	
2	Systemic Materialism	79
	Gustavo E. Romero	
3	Discontinuous Materialism	109
	Javier Pérez-Jara	
4	Quantum Matters	155
	Gustavo E. Romero	
5	Spacetime Is Material	177
	Luciano Combi	
6	Systemic Materialism in Biology	199
	Rafael González del Solar	
7	Mind and Matter	215
	Íñigo Ongay de Felipe	
8	Materialism and the History of Sciences	239
	Lino Camprubí	
9	Materialism, Logic, and Mathematics	269
	Carlos M. Madrid Casado	
10	The Material Nature of Software	303
	Miguel A. Quintanilla Fisac	
11	Mathematics Refer to Material Entities/Mathematics Do Not Refer to Material Entities	321
	Gustavo E. Romero and Carlos M. Madrid Casado	

**12 Emergent Materialism Implies Continuism/Emergent
Materialism Does Not Imply Continuism** 333
 Íñigo Ongay and Javier Pérez-Jara

13 Materialism Is False/Materialism Is Not False 349
 Graham Harman and Javier Pérez-Jara

Author Index 361

Subject Index 369

Author Biographies

Joseph Agassi, FRSC, studied in a rabbinical school in the Hebrew University of Jerusalem (MSc, physics) and in the University of London, where he was assistant to Karl Popper (PhD, general science: logic and scientific method). He was a parachute instructor in the Israeli Defense Force. He is professor emeritus at Tel Aviv University and York University, Toronto, and membro onorario del Corpo Accademico dell'Università degli Studi "Gabriele d'Annunzio," Chieti-Pescara, Italia. He has edited about 10 books and authored around 20, in addition to approximately 600 contributions to the learned press. Among them are *Science in Flux*, *Science and Society*, *Science and Culture*, *Science and Its History*, *The Siblinghood of Humanity: Introduction to Philosophy*, *Towards a Rational Philosophical Anthropology*, *Liberal Nationalism for Israel: Towards an Israeli National Identity*, *The Hazard Called Education*, and *Ludwig Wittgenstein's Philosophical Investigations: An Attempt at a Critical Rationalist Appraisal*. He also co-authored several books on philosophy of medicine and aesthetics.

Lino Camprubí is Ramón y Cajal Fellow in the Department of Philosophy at the Universidad de Sevilla, Spain, and the IP for the ERC CoG DEEPMED. He obtained his PhD in history at UCLA and has been a research scholar at the Max Planck Institute for the History of Science and at the Universidad Autónoma de Barcelona, as well as a visiting lecturer at the University of Chicago. He is the author of *Engineers and the Making of the Francoist Regime* (The MIT Press, 2014) and co-editor of *Technology and Globalisation: Networks of Experts in World History* (Palgrave, 2018) and of the special issue *Experiencing the Global Environment* (in *Studies in the History and Philosophy of Science*, Part A, (2018)).

Luciano Combi is a CONICET Fellow working at the Instituto Argentino de Radioastronomía (IAR). An Argentine physicist, he is interested in gravitation, cosmology, astrophysics, and foundations of science. He currently works on global-to-local relations in cosmology. He has published on the interpretation of quantum mechanics, general relativity, and alternative theories of gravity.

Rafael González del Solar, Doctor of Philosophy (UAB, Barcelona), former biologist, independent philosopher, and freelance translator. He has conducted research and published in both ecology and the philosophy of science, especially in issues related to explanation in ecology. He is currently expanding his research interests to the problem of human nature and the relation between science and belief.

Graham Harman is Distinguished Professor of Philosophy at the Southern California Institute of Architecture (SCI-Arc) in Los Angeles. He is the author of more than 20 books, most recently *Art and Objects* (2020). He is also the editor-in-chief of the journal *Open Philosophy*, series editor of the Speculative Realism book series at Edinburgh University Press, and (with Bruno Latour) co-editor of the New Metaphysics book series at Open Humanities Press.

Carlos M. Madrid Casado graduated in mathematics from Complutense University of Madrid, from where he obtained his PhD in philosophy of science. He has been a lecturer in the Department of Statistics and Operational Research II, Complutense University (2010–2017) and currently is an associate investigator at Gustavo Bueno Foundation (2014). His research interests include foundations of mathematics and statistics and the history and philosophy of mathematics and physics. Among other works, he is the author of *The Butterfly and the Tornado. Chaos Theory and Climate Change* (London: National Geographic, 2016), *Hilbert et les bases des mathématiques* (Paris: RBA France, 2014), *Fisher et l'inférence statistique* (Paris: RBA France, 2015), and *Brouwer. Un geometra tra topología e filosofia* (Milano: RBA Italia, 2018).

Íñigo Ongay de Felipe teaches philosophy at the University of Deusto in Spain and is a research associate at the Fundación Gustavo Bueno. Previously, he lectured as an associate professor at the Facultad de Filosofía de León (México) and as a visiting professor at Minzu University of China, Qingdao University, Shanghai Finance University, and at the National University of Costa Rica. His research covers a broad variety of issues ranging from the general philosophy of science, with particular attention to the philosophy of biology and life sciences, to the history of modern and contemporary philosophy. He is the author of a number of papers and of *El Proyecto Gran Simio desde el Materialismo Filosófico* (Universidad de Oviedo, Ph.D. Diss., 2006).

Javier Pérez-Jara is an Assistant Professor of Philosophy and Sociology at Beijing Foreign Studies University and a Faculty Fellow at Yale University's Center for Cultural Sociology. He has held visiting teaching and research positions across the world, including the University of Cambridge, Stanford University, Yale University, Kyoto University, Kyoto Sangyo University, the University of Seville, the Aristotle University of Thessaloniki, the Taiwanese Fu Jen Catholic University, and Minzu University of China. He is the author of many publications on philosophy and social theory, and his current teaching and research explore the theoretical and practical bridges between scientific interdisciplinarity and philosophy.

Miguel Á. Quintanilla Fisac is Professor of Logic and Philosophy of Science at the University of Salamanca (Spain). He is the author of many articles and books in various fields of contemporary philosophy of science and technology, social studies of science, and science politics. Highlights: *Tecnología: Un enfoque filosófico y otros ensayos de filosofía de la tecnología* (México: FCE, 2017) and *Filosofía Ciudadana* (Madrid: Trotta, 2020). For years he has held various positions of responsibility in Spanish scientific policy as a senator, Secretary General of the Council of Universities and Secretary of State for Universities and Research.

Gustavo E. Romero is Full Professor of Relativistic Astrophysics at the University of La Plata and superior researcher at the National Research Council of Argentina. A former president of the Argentine Astronomical Society, he is currently director of the Argentine Institute for Radio Astronomy (IAR). His work focuses on black hole physics, high-energy astrophysics, cosmology, and scientific philosophy. He has published more than 450 papers on astrophysics, gravitation, the foundations of physics, and philosophy, and 12 books, including *Introduction to Black Hole Astrophysics* (2014, with G. Vila) and *Scientific Philosophy* (2018), both published by Springer. He is a recipient of the Helmholtz International Award and the Houssay Prize, among other honors.

Chapter 1

What is Materialism? History and Concepts



Javier Pérez-Jara, Gustavo E. Romero, and Lino Camprubí

Abstract Despite the central presence of materialism in the history of philosophy, there is no universal consensus on the meaning of the word “matter” nor of the doctrine of philosophical materialism. Dictionaries of philosophy often identify this philosophy with its most reductionist and even eliminative versions, in line with Robert Boyle’s seventeenth century coinage of the term. But when we take the concept back in time to Greek philosophers and forward onto our own times, we recognize more inclusive forms of materialism as well as complex interplays with non-materialist thought about the place of matter in reality, including Christian philosophy and German idealism. We define philosophical materialism in its most general way both positively (the identification of reality with matter understood as changeability and plurality) and negatively (the negation of disembodied living beings and hypostatized ideas). This inclusive approach to philosophical materialism offers a new light to illuminate a critical history of the concept of matter and materialism from Ancient Greece to the present that is also attentive to scientific developments. By following the most important connections and discontinuities among theoretical frameworks on the idea of matter, we present a general thread that offers a rich and plural, but highly cohesive, field of investigation. Finally, we propose building on rich non-reductionist materialist philosophies, such as Mario

J. Pérez-Jara (✉)
Beijing Foreign Studies University, Beijing, China
Yale University, New Haven, CT, USA

G. E. Romero
Instituto Argentino de Radioastronomía (IAR) (CONICET; CICPBA; UNLP), Villa Elisa, Buenos Aires, Argentina

Facultad de Ciencias Astronómicas y Geofísicas, Universidad Nacional de La Plata, La Plata, Provincia de Buenos Aires, Argentina

L. Camprubí
Departamento de Lógica y Filosofía de la Ciencia, University of Seville, Sevilla, Spain
e-mail: lcamprubi@us.es

Bunge's systemic materialism and Gustavo Bueno's discontinuous materialism, to elaborate powerful theoretical alternatives to both physicalism and spiritualism.

In this chapter we aim at critically and constructively outlining the evolution of philosophical materialism in the Western tradition. This enables us to propose what we consider to be a broader concept of materialism than the one that is today often employed, and thus to provide a rigorous historical framework to the discussion of the subsequent chapters. Along its more than 25 centuries of evolution, philosophical materialism has remained in close contact with critical thinking, natural philosophy and science. Despite the frequent attempts of ideological kidnapping of the term "materialism" by physicalism or downwards reductionism, our main thesis in this essay is that a great variety of versions of this worldview have populated the history of ideas.

We define philosophical materialism in general in a dual but complementary way: positively, materialism names the branch of philosophical worldviews that identify being (the "ὄντος" of ontology) with matter, understood in its broadest sense as changeability and plurality (*partes extra partes*). Negatively, materialism denies the existence of disembodied living beings and hypostatized ideas and concepts. This leads us to identify some points common to all materialistic philosophies, such as: (1) there is an impersonal stuff of which the world, included living beings, is made of; (2) living beings, included human beings, are material complex entities determined by natural laws or regularities; (3) complex ideas and other conceptual artifacts cannot exist without the activity of some advanced living beings; and (4) nothing comes from nothing.

This general framework encompasses a multitude of distinct views and approaches. Because the concept of matter is an ontological notion supported on changing scientific theories, our journey begins in Miletus and takes us to the present through a wide variety of scientific and ontological stances. Along the way, the rivals of materialism—spiritualism and idealism—have also wore many masks. And yet, when it comes to accounts of the place of matter in reality, we move away from simplistic binary thinking and identify partial but important convergences between some varieties of philosophical materialism and some varieties of spiritualist and idealist philosophies, from Plato to Aquinas to Hegel. It is important to clarify from the onset, thus, that our approach is historical as much as it is philosophical. This means that not all scholars would agree with all of our historical reconstructions. Moreover, in this essay we have chosen to spend more time in arguments and interpretations usually absent from common accounts of materialism.

Both things (our own philosophical approach and the need to be selective) are especially evident when it comes to the sections devoted to twentieth century philosophical materialism. Drawing from our historical account, the goal of this section is to mobilize the distinction between exclusive and inclusive materialism in order to introduce two little-known approaches to philosophical materialism. The history of philosophical materialism is thus an essential component of a broader search for philosophical tools that enable critical thinking in the twenty-first century grounded both on the rich and complex philosophical tradition and on scientific knowledge.

1.1 The Naturalist Revolution

Miletus and the Origin of a New Worldview

There is an undeniable variety in the interpretations of Presocratic metaphysics. While ontotheological interpretations have been very influential (see for instance Jaeger 2003[1947] and Copleston 1993[1955]), in this essay we put forward a materialist understanding of a good part of early Greek metaphysics. It is true that the first Western philosophers often included God and the divine in their systems. And also that they at times accepted immortal spirits. Moreover, ancient *physis* (φύσις) encompasses much more than what we currently understand to be physical matter. Nonetheless, unlike traditional mythological theologies, the Presocratics built metaphysical systems where impersonal causes (i.e. explanations that do not involve intention or purpose) became the canon for rational explanations. Within this general approach, some of these thinkers developed materialist theologies in which the notions of God and the divine had a very different meaning from the one held by traditional mythological thinking.

It is not a coincidence that the first philosophers were also among the first truly scientific geometers. While geometrical practices and rules were around for centuries, the notion of demonstrative proof proceeding deductively from immanent entities and rules provided a model for rational explanation (Netz 1999; for other than Greek traditions, see Chemla 2012). The Presocratics applied this impersonal/non-anthropocentric model to the whole of reality. It is because of this totalization that we say, despite the word's anachronism, that they built the first metaphysical systems (Bueno 1974). Our approach, far from being groundbreaking, was founded by Aristotle himself (2016). He explicitly contended (*Metaphysics*, 983 b, 5–10) that the first philosophers believed that the only principles of all things were those of a material nature. Although our understanding of matter differs in very important aspects from Aristotle's one, we do believe that the Aristotelian thesis is worthy of attention.

The city of Miletus (located in Asia Minor, on the eastern shore of Aegean Sea) stood in the early years of the sixth century BC among the many colonies of Greeks belonging to the Ionian tribe. With three harbors and a strategic position, commerce between colonies and with the whole known-world made Miletus into an extremely prosperous city where peoples of different worldviews and religions traded, discussed, and studied. The first prose books were written in Miletus, where the wealth of merchants allowed the luxury of a high multi-cultural education to many citizens.

It was here that Western philosophy and a prototype of what we now call *science* were born. Six centuries before the Christian era, some Ionians offered the first geometrical proofs of long-known operations and results. In a world of competing religions and worldviews, being able to demonstrate something with the force of necessity must have looked like a safe haven. This equipped them to think about the nature of things and the origin of the world favoring immanent explanations

and without resorting to magical or mythological elements.¹ More specifically, they moved away from the anthropomorphism and zoomorphism that, until that moment, had tended to monopolize the explanations of the world and the human being in the Western tradition.

It used to be common to interpret this transition as the birth of reason. Nestle (1975[1940]) famously referred to it as the progress “from *mythos* to *logos*”. But this is a false dichotomy: there is *logos* in the myths. Scientific evidence coming from psychology, cultural anthropology, and sociology has established that traditional religious myths are rational in the sense of providing explanations of worldly experiences and phenomena in terms of anthropomorphic and zoomorphic analogies. Rather than inventing rationality, the Ionians performed something equally extraordinary: they inaugurated a way of reasoning that searched for impersonal mechanisms to explain the world and its transformations (even when they did not do away with personal myths altogether).²

Thales is credited to be both the first person to offer a geometrical proof or theorem and to attempt at providing a fully non-mythological explanation of the world. Attributions of precedence are always tricky, and very little is actually known about the extent of Thales’ real contribution. He apparently left no writings and not even classical Greeks agreed on the exact outlooks of his thought. Thales is said to have maintained that water was a generating substance from which everything else arose. Today, this claim seems arbitrary, but Thales must have observed that the so-called four natural states of matter could be explained by water and its transformations, from the solid state (ice) and the liquid, to gases and plasma (fire, believing that oil was made of water). No anthropomorphic or magical mechanism was involved in such transformations. Instead, an immanent element of the world served as first principle from which to deduce the rest. Whatever the actual contours of Thales’ metaphysics were, what is sure is that he had good pupils and must have been tolerant with their criticisms, a basic feature of the rational enterprise, since his disciple Anaximander offered a different account of the world.

Following Thales’ metaphysical approach, Anaximander nonetheless departed from his teacher’s confidence that the vastness of the empirical universe stems from such a common element as water. Anaximander suggested instead the existence of a special basic stuff that he called “the boundless” or the *apeiron* (ἄπειρον). This regression to an intangible substance beyond the appearances meant a significant

¹ Some of these philosophers, as we are going to see, used the language of traditional myth to talk about abstract philosophical conceptions; that is, they used that language as a set of rhetorical devices, along with giving traditional concepts (such as “cosmos”) a new philosophical meaning. Only a minority of them still held literal beliefs in traditional mythological elements (such as reincarnation). For that reason, although the new way of thinking that they created emerged from a specific sociocultural context (rather than appearing *ex nihilo*), it had enough new and revolutionary features to be considered and classified apart.

² Although Hesiod started his *Theogony* with an impersonal chaos (a prefiguration of later metaphysical notions), he also offered anthropomorphic explanations for the rest of natural phenomena.

step in the critical methods of science and philosophy. The basic points of Anaximander's view are: (1) there is an impersonal source or substratum from which everything arises, the *arche* (ἀρχή); (2) the world arising from *arche* obeys regular and lawful patterns; (3) what arises from *arche* is a number of substances, such as fire, air, earth, water; (4) these substances are later naturally arranged in a stable configuration that forms the cosmos (κόσμος), i.e., an ordered world; and (5) all living things emerge from these substances, evolving from simple to complex organisms (see Graham 2010; Kirk et al. 1983; McKirahan 1994, and Kahn 1994 for fragments and doxography; Graham 2006 and Long 1999 for interpretation and extensive discussions).

One important conclusion that follows Anaximander's ideas is that the morphologies of the cosmos cannot be neither eternal nor arising *ex nihilo*, an idea that still has a big influence in modern cosmology. The world is the result of a particular organization of the original stuff. It is likely that he coined the word "cosmos" in a philosophical sense. And it is not by coincidence that Anaximander is also thought to have produced the first Greek world map. This was part of his understanding of the cosmos as an ordered whole.

The theory of a generating impersonal substance proposed by Anaximander would be essential for the Milesian worldview. While the *apeiron* was obviously far from empirical, it was entirely *materialistic*, in the sense that the world was formed by, and only by, concrete substances governed by impersonal causes without place for supernatural phenomena. These substances can only change according to regular patterns, "out of necessity" (Kahn 1994; McKirahan 1994). This idea implies the powerful scientific and philosophical idea of the world's rational lawfulness. Changes are ordered in two ways: generation (and destruction) and motion (and change). This, along with the fact that things only exist for a determinate time span, gives raise to motion and change. The germ of the conservation laws of nature can be seen here. Of course, his theory had little predictive power and was thus impossible to test. And yet, his impersonal metaphysics was clearly distinct from mythology. To underline the difference from verse-written myths, Anaximander presented his view in prose.

Perhaps, Anaximander's most daring proposal was that there is one, and just one world, and that whatever happens in the world obeys cyclical patterns. There is no magic. If there are gods, they are part of the world as well; as such, they would be submitted to matter's lawful mechanisms. Things appear by evolution and not spontaneously. For instance, men evolved from different species of animals, and the world itself evolved impersonally from the *apeiron*. The *apeiron* is a source of the world but it is not present in it; its existence is inferred. Most of these features are shared by modern materialistic worldviews.

Anaximander's cosmological picture was as original as his ontology. Thales seems to have said that the Earth rests on the water; Anaximander rejected the need for support, explaining that the earth is stationary and at the center of the universe. The equidistance to any point explained that would not fall: there is no more reason to go in one direction than into another. This was the first known use of the principle of sufficient reason in the Western tradition. The stars, the sun, the

moon, and the planets were openings or holes that showed the fire that was beyond the skies. Anaximander's universe is discussed in detail by Kahn (1994).

Anaximenes (b. 585 BC, d. 528 BC) was Anaximander's younger friend—perhaps also his student. Following the Milesian tradition he criticized and tried to improve the theories of his mentor. He postulated that the generating substance was air, instead of the rather mysterious *apeiron*. The great advance made by Anaximenes was to describe a specific mechanism (i.e. a process or a series or processes) that would operate in order to produce the transformation of the various substances. This mechanism was based on the compression and rarefaction of air, and the other elements. When air is compressed, according to Anaximenes, it is transformed into water. The compression of water, in turn, results in the generation of earth, etc. This was an attempt to provide an immanent explanation of worldly phenomena built solely upon perceivable elements of the world itself. Anaximenes was also a proto-meteorologist, providing tentative (and mechanistic) explanations of phenomena such as the rain, the rainbow, and the lightening (see Graham 2013).

Generating Substance Ontology

Despite their differences, Milesian thinkers shared both a methodology and an ontological view. Contrary to a widespread opinion (e.g. Barnes 1982; Kirk et al. 1983), they were not radical *substance monists*: they accepted the existence of several substances. That there are diverse types of material substances is an important feature of some materialistic systems (e.g., Bueno 1972). But not all these substances were on equal foot. One type of matter might precede the rest, becoming the generating substance of the full set. In their attempt to account for reality as a whole, Milesian metaphysicians distinguished one such particular substance as responsible for generating the rest (Graham 2006). We call this ontological view the “generating substance ontology”. We can present this theory as a system of axioms (Graham 2006):

- There is a primary generating substance.
- The generating substance gives rise, through appropriate mechanisms, to derived substances or elements.
- When the generating substance changes, it ceases to exist.
- In turn, derived substances can rebuild the primordial substance.

If we adopt some current formal notation, we can express this set of statements as:

1. The world is composed by a collection of basic substances $S = S_1, \dots, S_n$.
Def. $S_i =$ basic substance.
2. $\exists S_g \in S$ / before a time t_0 , S_g was the only substance in existence.
Def. $S_g =$ generating substance.
3. $\forall S_i \in S \exists T / S_i$ is generated from S_g by the transformation T .
4. $\exists M/M$ is a material mechanism that enforces T .
5. The world exists in accordance to regular (i.e. legal) transformations of S_g and the derived substances.

This theory presents remarkable resemblance in structure with contemporary materialist theories. Namely: (1) Whatever exists is formed by, and only by, material substances on one or more types; (2) All phenomena are explainable by lawful mechanisms without place for supernatural events; (3) Human beings play no role in the general functioning of the world: the world is indifferent to human will; (4) Although the world is a material system, it is not alive, and hence has no personal attributes.

Heraclitus

Heraclitus was born in Ephesus, also in the Ionian coast, before the turn of the Sixth and Fifth centuries BC. He is famously associated with the maxima *Pantha rei*, “everything flows”, a formula actually given by Plato, and likely due to Cratylus. But it accurately highlights the contrast between Heraclitus and the Milesian theory of the generating substance. Only a few fragments of his writings have survived. The image of the world that emerges from them is one of diverse substances in everlasting change without a generating or original one (Graham 2010). It has been argued that fire played a similar role to Milesian water or air, or at least hold some kind of prominence over the rest. It is more likely, however, that he used it just as an example of something that can obtain stability by changing. Heraclitus, then, drew on the Milesian tradition and departed from it. But then again, criticism was part of the Milesian approach to knowledge. The conjectural character of knowledge would be later emphasized by Xenophanes, who was deeply concerned with epistemological issues.

Everything changes but change itself. As such, Heraclitus’ fire could be seen as a powerful metaphor of the essence of reality. As noted by Graham (2010): “Heraclitus does indeed believe in flux, probably of elemental changes, but unlike Cratylus he sees the flux as compatible with, or even the cause of, the stability of higher structures.” (for a discussion from the point of view of contemporary physics see Romero 2013). Heraclitus’ ontological views, like Buddha’s in the Eastern tradition, seem to be those of a forerunner of process philosophy. For him, change is the most essential feature in the world. Change is basic and legal (i.e. due to $\lambda\omicron\gamma\omicron\sigma$). Local change is necessary for global stability. The basic substances of the world are constantly undergoing transformation from one another. An important implication is that if change is legal then the world is not a chaos ($\chi\lambda\omicron\varsigma$); it is, as Anaximander has contended before, a cosmos ($\kappa\omicron\sigma\mu\omicron\varsigma$).

There is another important aspect of Heraclitus’ metaphysics. He showed a concern for the role or place of humans in the universe. In this aspect he can be considered a precursor of later Presocratics, such as Democritus and the Socratic and Hellenistic traditions. Heraclitus’ interests ranged from ontology to the nature of truth. As such, he appears to be the first Western philosopher with an almost complete philosophical system. Can we think of him as a materialist-oriented philosopher? There are good reasons to do so. Although emphasizing the role of change and deeding it as basic (and hence not requiring further elucidation in terms of mechanisms), Heraclitus did not deny the material nature of the world. He did not

deny, in particular, the existence of substances as some modern *trope* theorists would do (e.g. D.C. Williams). In a way he can be construed as a precursor of dynamicists.

True, Heraclitus wrote about a mysterious God and His divine laws (τοῦ θεοῦ). But this God is not the anthropomorphic God of traditional mythological thinking. Heraclitus clearly stated that “this world, the same of all, no god nor man did create, but it ever was and is and will be: everliving fire, kindling in measures and being quenched in measures.” (Kahn 1994). Heraclitus’ “God” seems to be a poetic way of referring to the universal *logos*, i.e., the main impersonal principle of reality, in which change and opposition is the source of everything. Things occur the way they do because of this *logos*/God, not because of the intervention of some all-powerful anthropomorphic consciousness. As the basic ontological principle that structures reality, the “divine” is manifest in every phenomena of the world. Heraclitus contended this view in a set of enigmatic quotes such as: “God is day night, winter summer, war peace, satiety and hunger”, and “the *logos* is unwilling and willing to be called by the name of Zeus.” Heraclitus’ God has the paradoxical nature of fire. Heraclitus also talked about War, the wise, the One, and the thunderbolt to refer to this impersonal principle that organizes all things. In Heraclitus’ metaphysics, the traditional supreme god of Greek religions is replaced by this impersonal principle. It seems very reasonable to assume that Heraclitus often used traditional religious terminology because he was aware of the fact that such metaphysical principle was taking the place of the traditional gods as the controlling element in the universe.³ Like the idea that “everything is full of gods” that Aristotle attributed to Thales, Heraclitus seemed to continue exploring the principles of what we could call a materialist theology, in which the words “God” and the “divine” had little resemblance with their former mythological meanings, supported on literalist anthropomorphism.

Heraclitus affirmed the invalidity of human projections of values to the universe in this way: “to God all things are fair and good and just, but people hold some things wrong and some right.” Since Heraclitus’ God is not an anthropomorphic entity, this just seems a poetic way of stating that reality, in general, is complete and perfect as it is, an idea that will inspire the Stoics as well as Hegel.

As for Heraclitus’ epistemology, Plato held that for Heraclitus knowledge is made impossible by the flux of sensible objects. But the Platonic view seems a distortion of Heraclitus’ actual view that “the things of which there is sight, hearing, experience, I prefer.” (B55). And, among the human senses, and like for Aristotle later, Heraclitus contended that “the eyes are more accurate witnesses than the ears” (B101a). That is, Heraclitus did not despise empirical knowledge, another (although not exclusive) key feature of materialist worldviews.

³ According to some scholars, such as Jennifer Peck, Heraclitus’ notions of *logos* and God, although very similar, should not be identified, since Heraclitus’ *logos* is the pattern present in all things, whereas God refers to the principle of unity of opposites. It is undeniable that Heraclitus’ fragments are obscure, and often difficult to interpret; but what seems clear is that for him, the notions of God and *logos*, if not identical, are very similar and refer to the universal impersonal mechanism and structure of reality.

Xenophanes

Xenophanes is an important reference for critiques of traditional religion: according to him, the gods have human characteristics, included human vices and weaknesses. Let us pay attention to these fragments:

Homer and Hesiod have attributed to the gods all sorts of things that are matters of reproach and censure among men: theft, adultery, and mutual deception (B11) [. . .]. Mortals suppose that gods are born, wear their own clothes and have a voice and body (B14) [. . .] Ethiopians say that their gods are snub-nosed and black; Thracians that theirs are blue-eyed and red-haired (B16) (Leshner 1992)

Xenophanes' conclusion, millennia before Ludwig Feuerbach (1804–1872), is that religion' gods are anthropomorphic creations. Xenophanes' critiques of traditional mythological thinking meant to strip natural phenomena of all vestiges of religious or magical significance. This can be seen in his proto-scientific theories, such as that stars come into being from burning clouds, or that the moon is made of compressed cloud. Nevertheless, Xenophanes also talked about a metaphysical God without traditional mythological characteristics, opening the way for later more sophisticated metaphysical theologies such as Aristotle's.

Parmenides

Xenophanes' main disciple, Parmenides (born at the end of the sixth century BC in Elea), deserves a crucial place both among the Presocratics and in the history of the whole Western philosophy. Parmenides put forward a radical critique of the concept of change cherished by Heraclitus. Although he used a poetic form of expression (probably influenced by Xenophanes), his was a rigorous analysis. He presented the first known philosophical deductive argument, which can be enunciated as follows:

- What is, is.
- What is not, is not.
- What is cannot come from what is not.

Then, being cannot come to be. Being is necessary.

As a consequence, since change requires ceasing to be something and coming to be something else, change is not possible: the world we see and touch is an illusion. Through this reasoning, Parmenides introduced the idea of nothingness as absolute non-being. But he set forth such idea in order to deny its very possibility. This ontological denial of nothingness, led Parmenides to the conclusion that the universe is absolutely homogeneous, complete, immutable, necessary and eternal (Coxon 2009). As such, reality is radically different from what our senses suggest and from what we naively accept.

To be incomplete is to lack or need something that is not. Since "what-is-not", is not, incompleteness is not. Being cannot lack anything. Being is complete, and if complete, it cannot change. The world consists of nothing but pure being. Despite its undeniable resemblances with some forms of Eastern metaphysics (such as the

Vedanta), it is difficult to exaggerate the perplexity and impact that this startling line of reasoning has caused in philosophical thinking along 25 centuries.

Parmenides' position was defended by Zeno and later expanded by Melissus of Samos.⁴ Parmenides' attack to the theory of a generating substance and change completely shifted the direction of philosophical speculation in the West (for a contemporary assessment and revision of Parmenides in the light of contemporary science see Romero 2012 and 2013). The world of Parmenides, being alien to change, cannot be said to be lawful in any meaningful sense. Lawfulness requires regular change, that only takes place in the illusory reality we perceive. This seems to exclude matter in any usual sense, since it is changeable by definition. If not made of matter, what are the world's building blocks? The question simply does not make sense in a Parmenidian ontology: the world is simple, so (although he imagined it as a giant and solid sphere) it cannot be made of anything. In particular it cannot be neither material nor immaterial.

Parmenides presented his philosophical theories as the revelation of a goddess, but since the essence of his metaphysics implies the denial of gods, it seems obvious that this was a rhetorical device: the gods, like everything else in the universe, are an illusion.

Later Presocratics

The reaction against Parmenides consisted in accepting some of his ontology, in particular accepting the absence of a generating substance, while negating other aspects, such as the impossibility of change. The pluralists, Anaxagoras and Empedocles, and the atomists, Leucippus and Democritus, proposed new theories of change, but mainly based on the emergence of new things from immutable components.⁵

Anaxagoras proposed that things are composed by the same things, but with varying proportions. According to this metaphysics, everything has always existed in some way. Originally, everything existed in infinitesimally small fragments of themselves. With this theory, Anaxagoras advanced a kind of primitive but extremely interesting fractal theory. Before the formation of the world, everything chaotically existed in this "fractal" impersonal mass. It seems very reasonable, therefore, to suppose that Anaxagoras' primitive mass was very influenced by Anaximander's *ἄπειρον* and Hesiod's *χάος*.

What moves Anaxagoras' metaphysics away from philosophical materialism is the role of the *Nous* (νοῦς) as a transcendental mind that orders a pre-existing set of material entities, helping to give them order. This *Nous* seems a metaphysical, rather than mythological, account of the idea of *spirit*. In any case, it is incompatible with a materialist worldview. According to Plato, Socrates was disappointed when

⁴ This philosopher introduced an important critique of Parmenides' view of reality as a (Euclidean) giant sphere: since a sphere necessarily implies an outer space, reality has to be *infinite*.

⁵ For a full account of the atomists, with fragments, doxography and commentaries see Taylor (1999).

Anaxagoras, after introducing the *Nous* in his metaphysics, started to give impersonal explanations of many natural phenomena, instead of using the *Nous* to take everything natural into account (see Bueno 1974). These impersonal mechanisms mean that there are also important convergences between Anaxagoras' worldview and a materialist approach.

For Empedocles, all things are made of combinations of four immutable elements: air, fire, water, and earth. This pluralist idea attempted to combine former ideas such as Thales', Anaximenes', Heraclitus', and Parmenides'. Empedocles' theory of the four elements was partially adopted by Plato and Aristotle, at least for pre-existing chaotic matter and the sub-lunar region respectively. Nevertheless, Empedocles' materialist approach enters in opposition with his belief in the metempsychosis or reincarnation of the souls. On the other hand, although Empedocles called "love" and "hate" to the two forces that, combining the four elements, explain change in the world, it seems that such forces are impersonal and that Empedocles' terminology is just metaphorical.

Finally, the atomists embraced indivisible substances which they called atoms (*ἄτομος*) moving across a void, somewhat similar to Parmenides' nothingness/non-being. Atoms themselves seem to infinitely multiply Parmenides' "being", since every atom remains unchanged and unchangeable. These infinite atoms are heterogeneously distributed throughout an also infinite space. Then, atoms combine to produce complex things, which can change by modifying their composition. The emergent things have also emergent properties (for instance, atoms are not alive, but they can form living things). Another important idea developed by the atomists is that, since there are infinite atoms in an infinite space, there is not a unique world, but an infinite number of them. Some of these important ideas would be later adopted by both the Epicureans and, although with very important modifications, a significant part of modern science (Gassendi, Boyle, Dalton). In all likelihood, Greek atomist theories were also based on empirical experiences, such as the analysis of grains of sand. Atomist doctrines were considered the archetype of materialistic theories after the so-called Scientific Revolution, despite that ancient atomists accepted the existence of the void which not all early modern atomists accepted. The Greek notion of atom as *indivisible* also limited, under some circumstances, a scientific modern understanding of real "atoms", composed of other particles.

At the end of the Presocratic period, the Ionian legacy had already shaped a new worldview. Let us enumerate some of the main elements of this anti-mythological outlook:

- Knowledge is gained through reason and experience. It is neither revealed nor based on the blind faith in an authority.
- All truth is subject to this (anti-mythological) epistemological approach.
- The value of a theory is given by its aptitude to represent the real world.
- No thought or idea is final. There is no perfect knowledge: everything is open to criticism.
- Natural phenomena obey impersonal laws. There is no place neither for magic nor for the literalist interpretation of traditional mythological thinking.

Plato

Again, it is likely that geometry, as the first instance of scientific knowledge, became a model for the Presocratic's search for impersonal lawfulness and epistemological rigor. Many of these thinkers were well versed in this science, which was in turn applied to the heavenly movements. Unlike Mesopotamian astronomy, Greek astronomy was geometrical (North 1994). The Pythagoreans took the power of mathematics to the extreme, hypostasizing the reality of geometrical beings. Together with Parmenidean denial of lawful change, they were a key in shaping Plato's philosophy, in turn essential to the formation of the later Christian worldview, with its clear differentiation of material and immaterial substances.

And yet, Plato constitutes a step beyond Presocratic metaphysics, properly introducing the philosophical method of critical and systematic appraisal of the different available worldviews and understandings of an impressive number of problems. Despite ulterior attempts at appropriation, his ontology cannot be easily reduced. Granted, there is a strong *dualistic* tendency. His unchanging *Forms* (immutable essences likely inspired in Pythagorean mathematical hypostases and Socrates' analyses of ideas), are clearly distinct from the changing material objects constituting the sensible world. Between matter and forms, however, there are also souls, that, although metaphysically closer to Forms, have enough ontological properties to be differentiated, thus breaking the original dualism. And, what's more, in Plato's metaphysics, the "Idea of Good" sits atop the ontological hierarchy of being. As such, it is more real than the Forms, and should be distinguished from them. Unlike the Idea of the Good, Forms are concrete abstract realities; or more specifically: they are (in our materialist terms) the hypostatized essence of things, regardless of their nature. In contrast, in Plato's metaphysics the soul refers to disembodied psychic activities. Both forms and souls, however, are intelligible, partless, and imperishable, thus existing eternally and independently from the material world. What happens to the objects in the world do not affect forms. They are not in space and time. Consequently, they are changeless. Epistemologically, it meant that change prevents perfect knowledge. Since the material world changes, it cannot be perfectly known. We can only have conjectural knowledge and true *belief*. Perfect knowledge is only possible of the Forms, which partake of whatever exists. But this has provided a method for philosophical thinking critical of worldly and seemingly intuitive opinions. Plato's theory of Form can also be interpreted as his attempt to find a compromise between Heraclitus and Parmenides: although it only affects to a part of reality, change is real. But its ontological and even moral status is inferior than changeless realities. Matter is worse and less real than souls and Forms.

According to several current definitions of matter (e.g. Bunge 2010; Romero 2018), we can say that Forms are *immaterial*. But it is also true that Plato's Forms can be appreciated from philosophical materialism, since it defends that philosophy deals with the analysis of ideas and their systematic relationships, which are beyond our will. This conception of ideas as abstractions submitted to objective relations is key against psychological reductionism and radical relativism. Despite

its unjustified idealist hypostases, the theory of Forms thus deserves to be considered revolutionary in the history of Western metaphysics.

Plato's concept of the soul ($\psi\upsilon\chi\eta$) is also more complex than many of its Christian appropriators allowed for. For ancient Greeks, the soul was the essence or principle of life in a living thing. This does not necessarily imply an immaterial nature. For instance, Heraclitus seems to state that mental capacities are perturbed in the drunk because of the moistness of the soul. With important exceptions such as Anaxagoras' *Nous* and Empedocles' metempsychosis, the acceptance of the soul did not imply, for the Presocratics, the rejection of some form of materialism. The soul was what animated the body, and with the destruction of the body the soul might either disappear or move on and animate another organism. Plato, instead, tended towards dualism. For him the soul is immaterial and immortal, but with all the capacities we now call "mental": thinking, desiring, feeling, perceiving, and so on. The soul's true destiny is contemplation of the Forms. This is better achieved *after* death, when the immortal soul is free from the distractions of changing matter. While Plato in some texts defended the soul's simplicity, in others he contended that that soul has different parts, some of them even unconscious (Pérez-Jara 2014).

Plato's idea of God was also very different from the God of the so-called monotheistic religions (Kirsch 2005). Inspired by Anaxagoras and Socrates, Plato thought that the universe was created by a God (a Demiurge). This Demiurge, however, is certainly not the source of all beings. The Forms are eternal, and the Demiurge uses them to give order to a pre-existing chaotic matter. The world, however, falls short of the ideal. Not because of the Demiurge's clumsiness, but because of the raw materials at his disposal. Although the Demiurge is not omnipotent, he is benevolent: he tried to produce as much perfection as possible from the chaotic matter he found. Since the material world is not created *ex nihilo*, the Demiurge was unable to prevent evil from existing in it. Moreover, the Demiurge is not alone. After the creation out of a preexisting material he withdrew, leaving the running of the universe to lesser gods. He detached from his creation so he does not participate of its imperfections.⁶ This negative view of change and matter led to Gnostic doctrines several centuries later.

Finally, another key concept of Plato's metaphysics is the idea of *sympleke*, defended in *Sophist* (251e–259e). According to it, not everything is connected to everything else. As such, Plato's principle of *sympleke* works as a preliminary form of the ontological thesis that reality is composed of a complex interplay of continuities and discontinuities (Bueno 1972; Bunge 2009[1959]). Plato's ontological and epistemological principle of discontinuity has a special significance for philosophical materialism and its critiques of theological and spiritualist holisms.

⁶ It is important to note that Plato talked about the Demiurge using the explicit language of myth. Since in several *Dialogues* Plato used other myths as allegorical teachings rather than literalist dogmas, it is also possible that his myth of the Demiurge has a non-literalist anthropomorphic reading. But while in other Platonic myths the allegorical reading is clear, in his myth of the Demiurge it is not. For that reason, it is more than likely that Plato, as Anaxagoras and Socrates before, held a real belief in some kind of personal mind that gave form to the world.

Aristotle

Aristotle's philosophy can also be interpreted as a pluralistic one. Aristotle was Plato's most successful pupil in the critical philosophical tradition. He deviated significantly from many of his master's views, starting with the notion of the soul. For Aristotle, the soul is just what makes an organism to be alive. And, rather than hypostatized entities as in Plato's metaphysics, Aristotle's Forms are a part of the universe's substances. Ideas are generated by human beings' processes of epistemological abstraction, and Forms cannot exist by themselves, but always united to matter. The ontological symbiosis between matter and form is one of the main features of Aristotle's ontological theory. In the nineteenth century, this approach became known as *hylomorphism* (or *hylemorphism*): every concrete substance is composed of matter and form. Aristotle's only exceptions to hylomorphism are prime matter and God(s). Prime matter is pure potentiality, as such, is not a factual reality, but an abstraction of the stuff of what every substance is made of. God, in turn, is pure actuality without matter. Since Aristotle's God is not composed of matter, he/it is not a substance. Aristotle's God is not a mythological God: it is an immutable entity that does have neither created the world nor know it: it is absolute reflexivity, thought of thoughts (νοήσεως νόησις).⁷

Aristotle is also well known for advancing key ideas in cosmology, physics and living beings. Some of them dominated Western views of the universe until the seventeenth century AC. With regard to cosmology, Presocratic views were clearly influential in shaping Aristotle's great synthesis. The main points of this cosmology are:

- The universe is eternal, finite, and spherical.
- The heavens are composed of a fifth element: 'ether'.
- The Earth is the center of the universe.
- There is no central role for man in the machinery of the universe.
- Natural motion in the sub-lunar sphere is rectilinear. In the higher spheres, motion is circular.
- Everything on Earth is made up of four elements (earth, fire, water, air).
- The 4 elements are affected by properties (dryness, coldness, humidity, heat).
- Substances are composed of form and matter.
- Change involves the change of form and the permanence of substance.
- There are four types of causes: material, formal, efficient, and final.
- All the possible kinds of things that can be the subject or the predicate of a proposition can be analyzed by some key categories such as: substance, quantity, quality, relation, place, time, situation, condition, action, and passion.

This last point has often been interpreted as a linguistic one. There are, however, good reasons to think of at least some of these categories as having ontological

⁷ Aristotle also considered the existence of lesser "gods" who, along with the main God, move the planets, but they do so in a completely impersonal and blind way.

significance (Haaparanta and Koskinen 2012). Aristotle's thesis that "being is said in many ways" thus extended and fortified Plato's pluralistic principle of discontinuity.

The Hellenistic Period

East-West interaction brought about by Alexander The Great's campaigns and subsequent exchanges changed the focus of philosophical thinking from ontological to ethical problems. In the so-called Hellenistic Period, extended roughly from 350 BC to 200 AC, several new philosophical schools appeared and those already in existence underwent an important shift in their topics of research and speculation. This was, of course, a matter of degree. Before that time, philosophers had also been interested in ethical and anthropological issues, just as Hellenistic thinkers did not reject metaphysical and epistemological speculation. But now the major concern of most of these new philosophical schools was to answer the question: "what is the right way to live?". Aside of important Eastern influences, their views were also strongly modeled by those of their Greek predecessors. For instance, Epicureans, adopted an atomist and clearly materialistic point of view while the Stoics adapted and to certain extent naturalized Anaxagoras' notion of *nous*, developing an original materialist theology also heavily influenced by Heraclitus' *logos*/God, in which God is material and matter is divine. Epicurus reformulated Democritus doctrine introducing several innovations (see, e.g. Marx 1975[1841]). In both Epicurean and Stoic philosophies ontological views as well as their application to the explanation of natural phenomena played an important role as the funding blocks of their respective ethical systems. Both systems in their own way aimed, through knowledge of the external world as well as of our inner nature, at freeing us from fear and anxiety. In several ways, the Epicurean system, as well as the Stoic and Cyrenaic ones, replaced religion and the necessity of an ethics based on divine whim by a naturalistic system based on knowledge of nature. For Epicurus, gods may exist, but they are material, that is, composed of atoms. Through this thesis, Epicurus developed another kind of materialist theology that denied supernatural phenomena and religious activity.⁸ The human soul is also composed of particular aggregates of atoms, and when they are dismantled, the soul fades away. Given our constitutive finitude and mortality, the wise person knows how to live in order to achieve a state of tranquility and avoid pain and fear as much as possible given the world's conditions.

Pyrrhonism also pursued the ethical goal of *ataraxia* (ἀταραξία) or "imperturbability", but they thought that true knowledge was impossible to achieve. As such, Pyrrhonics recommended a suspension of judgement about matters of belief. Classic schools such as Peripateticism (based on the teachings of Aristotle) and Platonism underwent significant transformations in this period. The former aspired through knowledge to virtuous actions, which, they considered, result in happiness. What

⁸ Although Epicurus considered Greek mythology's gods as human fictions, he recommended his disciples to visit Greek temples and contemplate the serenity of the gods' statues. Such activity could have psychological and ethical benefits.

actions are virtuous we can know from our study of nature and trying to evaluate which is the mean path between extremes. The Platonists moved towards skepticism, but maintaining that, although we cannot aspire to certainty, we can at least approach the truth through degrees of truth-likeness, and hence degrees of belief, which allow one to act.

A full account of all these schools (and others of the period) is impossible here. The interested reader is referred to the classical works by Long (1974) and Long and Sedley (1987). It is enough to emphasize that materialistic worldviews were abundantly available in the time and, after the first century AD, in clear competition with Christians and Gnostics. When Christianity resulted triumphant after the third century, the Hellenistic schools were obliterated. The Christian worldview, strongly influenced by Neoplatonism and Eastern religions with their strong spiritualist doctrines, was dominant for the following fourteen centuries. The next section turns to analyzing the complex panorama of Christian understanding of matter and its place in the world.

1.2 The Creationist Turn

Christian views on matter during the Roman Empire and the so-called Middle Ages constitute one of the thickest jungles one could venture into. The reason is simple: from the onset, multiple and conflicting Christian worldviews coexisted, often accusing each other of the most terrible heresies (Freeman 2011; Papandrea 2016). Even after the official view of the Catholic Church was imposed in the late Roman Empire, the fight within Christianity continued for legitimacy and the monopoly of truth (MacMullen 1984). From emperor Constantine on (and exacerbated under Theodosius I), Catholic persecutions against “idolatry” and “satanism” almost eradicated every non Jewish or Christian religious cult, dubbed as “Paganism” (Jonathan 2005). Once Paganism was practically annihilated, inner Christian fights carried on, sometimes violently. In these confrontations, every new winner transformed the meanings of orthodoxy and heresy, as it had happened since the birth of Christian movements (Bauer 1971). These disputes concerned the nature of Jesus Christ or the Salvation, but also understandings of matter.

In this section, we suggest some Ariadne’s threads that might guide us through this labyrinthine plurality, which is often downplayed or even ignored by both Christian apologists and anti-religious thinkers. The main hypothesis that we follow in this section is that, despite the diversity of Christian theologies, it is possible to find some key binary oppositions to understand Christian ideas about matter: (1) the majority of Christian views combined *mythological* perspectives about matter and human being with *metaphysical* ideas from Greek and Roman philosophy, a theoretical tension that has lasted until now; (2) they kept a dual (sometimes even schizophrenic) understanding of matter as both *good* (since it has been created by God) and *evil* (since it is the opposite of the spirit and is tainted by the Devil); (3) they often followed the Platonic and Neoplatonic (and later Aristotelian) views of

matter as a passive and negative reality, as opposed to active and positive *forms*; (4) against the prevalent Greek view of matter as *necessary and uncreated*, the majority of Christian worldviews introduced the idea of matter as a *contingent reality created ex nihilo* by an all-powerful God. Let us elaborate further on each of these dichotomies.

(1) The Structural Tension Between Mythology and Philosophy in the Christian Understanding of Matter

Mythological worldviews and philosophical worldviews should never be understood in simplistic binary terms; both perspectives always have convergences, and in many occasions their borders are blurry. For instance, Hesiod's idea of chaos has a metaphysical side and Plato's, Epicurus's, Lucretius's or Hobbes's God(s) are not only mythological. In order to make the opposition between mythological thinking and philosophical thinking as clear cut as possible, we will reduce here mythological thinking to the *literalist interpretation* of anthropomorphic and zoomorphic metaphors and allegories. As such, when some myths can be interpreted in more abstract/allegorical terms, we will not consider them "mythological". Up to what point many of the Bible's myths were written as allegories that, only with the passage of time became interpreted in literalist terms as their specific political contexts of origin faded, is a fascinating debate that obviously exceeds the limitations of this chapter (but see for instance Day 2002, 2015). But that the original meaning of many Biblical stories was obscured or totally distorted by later interpretations should not lead us to downplay those later interpretations: they were the ones with more historical and cultural relevance.

To complicate matters further, often Biblical stories were interpreted in allegorical terms different from the metaphors of origin. Because of his familiarity with the Hellenistic literature, Origen of Alexandria (AD 184–253) is perhaps the best example of a Christian theologian seeking allegorical interpretations of Biblical myths (Coakley and Sterk 2004). Nevertheless, he lacked sufficient historical and sociological background to reconstruct their original metaphorical meanings. Additionally, Origen was far from embracing total allegorism, for he held literalist beliefs in the real personal character of God and the Devil as well as of angels and demons. As for Biblical literalism, Tertullian (AD 155–220) is a paradigmatic example of an author who pleaded for a literalist reading of Biblical myths (Dunn 2004). On the other hand, St. Augustine (AD 354–430) sought a theological middle ground between allegorism and literalism (MacCulloch 2010).

This structural tension between literalism and allegorism in the Christian world was reflected on three main positions: (a) *fideism*, according to which only Faith matters, and non-literalist interpretation of the Bible and the Revelation should be consider as the work of the Devil; (b) *allegorism*, according to which the myths present in the Bible and other sources of Revelation should always be considered as stories founded on poetic metaphors; (c) *ratio-fideism*, or the middle ground between the previous positions, according to which some myths should be interpreted in allegorical terms, whereas others (such as the personal nature of

God, the resurrection of Christ, or the immortality of the soul) should be read in literalist terms. After many heated debates, this latter option became the prevalent in the Catholic tradition. Total allegorism became synonym of atheism, whereas fideism, before Luther, was cornered, being held only by minority Christian communities. This compromise between philosophical thinking and literalist–mythological thinking forced the conciliation of philosophical Greek views on matter with Jewish and early Christian (but also Greek and Zoroastrian) mythological views on supernatural spirits, miracles, and prophecies. But not all Greek philosophy qualified. Presocratic, Stoic and Epicurean understandings of φύσις did not mix well with a literalist reading of the core Christian dogmas, and thus were rejected as heresy.⁹ And Aristotelian philosophy was largely forgotten for many centuries until their Arab rescue. Understandingly, then, Platonism and Neo-Platonism dominated the philosophical side of Christian approaches to matter.

These approaches started to form slowly, as allegorical readings were only tolerated as long as they did not threaten the authority of Christian communities (Freeman 2011). If Christianity spread first over the Roman Empire’s lower classes, wealthier (and therefore more educated) citizens were also fast to adopt it. Among them were Stoic and Neoplatonic philosophers. St. Justin Martyr (AD 100–165) is a perfect example of an intellectual with philosophical background in Stoicism, Aristotelian, Pythagorean, and Platonic who converted to Christianity. Thinkers like him navigated an unstable equilibrium between the literalism necessary to belong to a specific Christian community and the allegorism imposed by their own philosophical formation (Freeman 2011).

St. Paul and most Fathers of the Church knew that, if Christian communities were to attract the masses, they had to respect the literalist interpretation of Biblical myths. The price to pay was high: the literalist interpretation of myths concerning anthropomorphic divinities, angels, demons, miracles and prophecies was difficult, if not outright impossible, to conciliate with a non-dogmatic and rigorous understanding of the material world. This debate is still alive in our times in current debates between Christian and non-Christian scientists and philosophers about evolution, the history of the universe, and the destiny of humankind (Bueno 2007).

(2) The Dual Understanding of Matter as Good and Evil

Another important paradoxical understanding on matter in Christianity was related to the very ontological and moral nature of matter itself: is it good or bad? On the one hand, matter has an unquestionable good side because it has been created by the true God. As the beginning of the Book of Genesis informs us, God was indeed satisfied with the His Creation of the material world. True, this was before the “original sin” tainted the Creation (Nebe 2002). But the fact that the Old Testament’s God

⁹ The case of the relationships between Stoicism and Christianity is very interesting. Several Stoic ideas related to ethics and politics were accepted and transformed by some Christian thinkers, at the same time that they rejected Stoic metaphysics.

constantly rewards his loyal followers with material belongings must also be a sign that matter is to some extent holy.

Matter's positive valuation was also emphasized by three main dogma, namely: (a) The Incarnation, according to which God Himself voluntarily decided to incarnate in a human being: Jesus Christ as Holy Savior of humankind. God could have decided to act as a pure spirit or use one of his angels;¹⁰ instead, the Second Person of the Trinity willingly *became flesh*, revaluing matter in the process; (b) The Eucharist: miraculously, God himself becomes materially present in bread and wine during the Holy Communion; (c) The Resurrection of the Dead: contradictions and ambiguities notwithstanding (Freeman 2011), the official Catholic view on the afterlife included the immortality of both soul and body. Our resurrected bodies, though, will not suffer the devilish corruption of our earthly bodies. They will be heavenly bodies, able of the prodigious capacities that St. Paul promised us. But *bodies*, all in all. Furthermore, by postulating that our resurrected glorious bodies can take the place of another body and can be at several places simultaneously, the Dogma of the Resurrection of the Dead broke with the traditional identification of matter with impenetrability and locality. And this was explicit in the rich theology of St. Thomas Aquinas's revolving about the glorious bodies, a fascinating mixture of metaphysics and mythology (Aquinas 1948 S. Th., III, q.57, IV; Bueno 1990b: 70). On the other hand, matter appeared as the source of evil, corruption, and sin. Christian Gnostics went the farthest in demonizing matter. According to them, the material universe is not the creation of God but of an evil Demiurge, sometimes known as Yaldabaoth. As such, matter is the source of evil and corruption (Brakke 2012). Although less radical than the Gnostics, Neoplatonic Christians also were generally inclined to condemn matter. According to Plotinus and several of his disciples, there is nothing ontologically below matter (Wallis 1995). Matter is just the most degraded form of being. As such, matter could be poetically understood as when light is closer to the darkness. Which in metaphysical terms means that, for Neoplatonism, matter is close to nothingness (Slaveva-Griffin and Remes 2017).

Negative connotations of matter were not exclusive to Gnosticism and Neoplatonism. St. Paul's and his disciplines' writings achieved wide recognition among Christian communities (Freeman 2011). In Pauline theology, "flesh" is the main source of sin, in opposition to the spirit, the source of good and justice.¹¹ As distinct to the spiritual world, material reality is tainted by sin, corruption, and imperfection. This binary understanding of matter as opposed to the spirit is also present in Plato and other traditions. But, within the Western tradition, it reached its utmost

¹⁰ This is Docetism's theological doctrine, according to which the body of Jesus was an illusion. But, despite its partial influence in other Christian communities, Docetism was soon perceived as a dangerous heresy by more powerful and popular forms of Christianity: see Wahlde (2015), Freeman (2011), and Papandrea (2016).

¹¹ Through these binary oppositions between the sins generated by matter, and the virtues generated by the spirit, St. Paul did not seem no notice the theological contradiction that it was not matter, but the pure spirit of Satan who introduced evil in reality, before the creation of matter.

radical versions in Christian thought.¹² John the Baptist, Jesus, the twelve apostles, and St. Paul engaged in different ascetic practices based on the binary opposition between matter and the spirit. Late Antiquity's Christian theologians such as St. Ignatius (AD 35–108), Origen, St. Jerome (AD 347–420), St. John Chrysostom (AD 349–407), and St. Augustine also endorsed ascetic practices, supporting them on interpretations of Biblical texts. Most, however, were not radical ascetics. Christian asceticism reached its peak during the decadence of the Roman Empire with the movement of the Desert Fathers and Mothers (Chryssavgis 2008). Interpreting the empire's political, economic, and sociocultural crisis as unequivocal signs of the futility of the material life and the imminence of the Judgment Day's coming, St. Anthony the Great (AD ?-356) moved to the desert in AD 270–271. His main goal was to renounce to the material world tainted by the Devil, consecrating himself to the spiritual world blessed by God. St. Anthony the Great's extravagant practices became a sort of trend. By the time St. Anthony the Great died in AD 356, thousands of monks, hermits, and random ascetics abandoned everything to live in the desert. Depriving themselves of food, comfortable shelter, sex, and personal hygiene, as well as self-inflicting pain and voluntary suffering, they wanted to remove themselves as far as possible from the material temptations that corrupt the spirit, moving it away from God (Robinson and Rodrigues 2014). Paradoxically, this counter-cultural movement became so popular that St. Anthony's biographer, Athanasius of Alexandria (AD 296–373), wrote that “the desert had become a city.” (Chryssavgis 2008).

The radical spiritual movement of the Desert Fathers and Mothers, with major figures such as St. Mary of Egypt (AD 344–421) and St. Simeon Stylites (AD 390–459), had a major influence on the theoretical and practical development of Christianity (Johnston 2013; Weidemann 2013; Peeters et al. 2011; Chryssavgis 2008). Although this radical anti-materialism eventually faded away, Christian asceticism and its ideological justifications did not. Centuries after the Fall of the Western Roman Empire, in the twelfth century, the religious text *De Miseria Conditionis Humane*, written by cardinal Lotario dei Segni, later Pope Innocent III (1977), elaborated on the misery and corruption of material existence.

Most branches of Christianity did not so radically condemn matter and accepted it as a creation of the true God. But even then, Christian thinkers emphasized the metaphysical gap between God and the world. Some authors ignored this dual understanding of matter as holy and as profane. Christian pantheistic theologians such as David of Dinant (1160–1217) and Giordano Bruno (1548–1600) went as far as identifying God with the material reality. As a consequence, of course, they were punished as heretics. But, even within the official Catholic orthodoxy, it was possible to defend a middle ground between glorifying and demonizing matter. The best example is St. Thomas Aquinas (1225–1274), whose crucial importance in

¹² Even though Plato drew from the Orphic despise of matter, he did not plea for asceticism and mortification of the flesh. On the contrary, Plato encouraged good nutrition, bodily aesthetics, and sports.

Christian theology lasts until the present day. But there are other less spectacular examples. The theology of Raymond of Sabunde (1385–1436) contemplated both “the book of Nature” and the Bible as Divine revelations (Díaz Díaz 2003). As such, the material world reveals God’s perfection and goodness.

Jewish and Islamic theologies, which were also under the aegis of Greek philosophy, faced a similar conundrum of a dual consideration of matter. Within Jewish creationism, Solomon ben Yehuda ibn Gabirol, more popularly known as Avicbron (1021–1070), asserted the ontological dignity of matter with his thesis of the *materia universalis*. According to it, everything created by God, including the soul and intellect, is composed of matter and form (Avicbron 2014). According to this metaphysics, matter is not passive. Rather the contrary, matter is the active.

On the other hand, some schools of Islamic theology identified matter with the evil and the profane. In the *Al-Isq* and the *Al-Nachat*, written by the Neoplatonic Avicenna (980–1037) matter is that from “which all evil proceeds” and it is comparable (in doubtful poetic terms) to a “vile, dishonored, and ugly woman.” (Gutas 2014). Only by receiving *ad extrinseco* the forms given by God (the *dator formarum*) can matter recover some ontological dignity (Bueno 1990a,b). Important to also note is that, for Avicenna, forms do not change in themselves. But the substratum, matter, can change by suppression of form. Activity comes from internal forms called “natures”. Avicenna also added a new form to the classical forms of Aristotle, the *forma corporeitatis*, or bodily form. Matter always have some form of corporeity. This, with time, became the common meaning of the word “form”. It was not until the nineteenth century that matter without corporeity was first postulated and then found experimentally (the electromagnetic field).

(3) Matter as Negativity and Passivity

This Greek-inspired opposition between matter and form went hand in hand with the relation between passivity and activity. This was already so in Plato and Aristotle. But not for the Presocratics, the Stoics, and the Epicureans. Both Presocratics’ φύσις and Stoics’ naturalist God, along with Epicureans’ atoms, are unquestionable active and positive realities. Christian theology, however, overwhelmingly ignored these views in favor of an understanding of matter as negative and passive and of form as positive and active.

The interesting paradox is that mythological influences took many Christians to believe that matter is as an active source of sin and corruption (Freeman 2011). The contradiction between the philosophically-inspired doctrine of matter as passive and the mythologically-inspired view of matter as active led to innovative results in Platonic Christian thinkers such as St. Augustine. His mythological theology emphasized the active reality of evil while his metaphysics presented evil as a *privation* of good. Although with degrees, everything created by God is actively good. The passive formlessness of matter is not an absolute negativity, for matter has the positive capacity to receive God’s forms (Gilson 1960; Bourke 2019). Similar metaphysical imbroglios about the negative/passive and positive/active character of

matter can be found in later Christian thinkers heavily influenced by Aristotle, such as St. Albertus Magnus (1200–1280) and, above all, St. Thomas Aquinas.

One of the most important Islamic philosopher of all times, Ibn Rochd (1126–1198), maintained that there are forms intrinsic to matter itself (and hence subordinated to it). This implies, contrary to traditional Platonic, Aristotelian, and Neoplatonic views, that matter, the substratum, is accesible to knowledge and deserves investigations. This idea will be very influential in late Scholastic philosophy, as we will see in the next section.

(4) *Matter: From Uncreated and Necessary to Created and Contingent*

The idea of *creatio ex nihilo* is a very late concept in Judaism and even in Christianity. It does not explicitly feature neither in the Old nor the New Testaments (Young 1991; May 2004; Blenkinsopp 2011). Antiquity's demiurges did not create out of nothing: they gave shape and order to a preexisting chaotic matter (May 2004). In the Bible's creation myth, God is the order-giver (Day 2015). Contrarily, the idea of *creatio ex nihilo* implies the idea of nothingness as the absolute non-being. And it is very difficult to keep track on the idea of absolute nothingness before Parmenides, or, more generally, Greek metaphysics (Young 1991). During the first four centuries AD, Christian theologians held heated theological discussions with contemporary rivals about the nature of God and the material world. Among those opponents, Gnostics played a key role in making Pauline Christians to develop, influenced by Greek metaphysics, the idea of *creatio ex nihilo* (May 2004).

Creationism was an original idea. Although Greek thinkers knew it, they abhorred it for contradictory (Bueno 1974). But even Christian creationism was severely nuanced by its own Greek roots. Again, Neoplatonist Christian theologians were confronted by this contradiction most directly. In St Augustine's *De diversis quaestionibus*, God created the world using the ideas existing in His divine intellect as paradigms (Gilson 1960). The implication is that, in truth, there is nothing really new in the Creation: only "matter" as the passive receptacle that God creates to incarnate the ideas/forms. The world, with all its stars, mountains, empires, rivers, animals, and individuals was contained in God's mind for all eternity: God "actualizes" in matter what exists eternally in his divine intellect. Christian creationism becomes here a crypto-neophobic metaphysics, for there is nothing really new that has not existed in the divine mind eternally.¹³ The contradiction is inescapable. In order to avoid materialism and naturalism, Christian creationism falls down into a circular reasoning (Pérez-Jara 2014). Even the Christian nominalist

¹³ Here, we use the concept of "neophobia" in Bunge's critical sense, i.e as the metaphysical approach that denies ontological novelty in reality: "The most popular idea about novelty is that whatever appears to be new actually existed previously in a latent form: that all things and all facts are 'pregnant' with whatever may arise from them. An early example of such neophobia is the conception of causes as containing their effects, as expressed by the scholastic formula 'There is nothing in the effect that had not been in the cause'." (Bunge 2010, p. 87).

version of the Creation begs the question, for God also had in his intellect the infinite individual things that He actualized in the Creation.

To complicate this picture further, not all Greek thinkers thought of matter as absolutely necessary; there was also room for contingency and freedom. Regarding the cosmos, the specific morphologies of matter are neither necessary nor eternal: for Hesiod, our current cosmos derives from *chaos*; for Anaximander, from *apeiron*; for Anaximenes, from *magma*; and for Plato, from a previous chaotic matter. Only Aristotle postulated the eternity of the cosmos' supralunary morphologies (Jaeger 2003[1936]). Regarding the human sphere, necessity is not absolute either. Take Aristotle's criticisms of the Megarians' fatalism (see Aristotle 2016, 3 T). Or the late Greek Tragedy of Euripides, in which human freedom is much more prevalent than in Aeschylus' and Sophocles' works (Lorau 2002; Critchley 2019). These ambiguities and richness reproduced in Christian theology. Freedom and contingency are subject to God's omniscience, providence, and omnipotence. But fatalism is politically and morally futile. The contradiction between freedom and the Christian God reached its climax in Luther's *De servo arbitrio*, and shortly after during the polemic between Dominicans and the Jesuits that gave rise to the *Congregatio de Auxiliis* (Buono 1996).

These four binaries (mythical/philosophical, good/evil, active/passive, necessary/contingent) were not the only ones given texture and complexity to the Christian ontology. But they have served here as the main threads to find our way through the labyrinthine jungle of Christian metaphysics. With the exception of Gnosticism and pantheism, Christian views on matter always saw matter as a product created by God. As such, matter was thought as a reality planned, created, and ordered by a divine spirit. General Christian understanding on matter in creationist terms meant that Christian ontologies of matter were eminently teleological, postulating final causes in every corner of nature, along with a monism of order.¹⁴ Since the divine spirit was thought as infinite and omnipresent, penetrating into every material domain, this view implied a sort of *hubris* or hemorrhage of the psyche radically antagonistic with a materialist understanding of the universe (Pérez-Jara 2014). To understand matter meant, at least in part, to understand God's plans.¹⁵ Therefore, as long as many of the divine plans are a mystery to us, matter will not be epistemologically transparent to us. For many centuries, Christian ontology of matter clearly determined Christian epistemology of matter in a radical spiritualist way which would then live on in non-theological philosophies. With very few exceptions, until the end of the Middle Ages, the majority of Christian thinkers downplayed empirical investigation on matter. A paradigmatic example of this tendency was represented by St. Augustine and his in "*interiore homine habitat veritas*" (Gilson 1960; Bourke 2019). Christian epistemologies of matter

¹⁴ According to which everything is connected with everything else through God (Buono 1972).

¹⁵ Aquinas even defended that matter could be eternal, despite been created by God. Only by Revelation do we know that the material universe had a beginning in time: see Aquinas (1948) and Gilson (1960).

took the lead in late medieval times, with Robert Grosseteste (1175–1253), St. Thomas Aquinas, Roger Bacon (1214–1292), and Raymond of Sabunde (1385–1436) much more open to empirical research and, therefore, closer to materialism (Crombie 1953).

With very few exceptions, Christian spiritualist creationism dug a huge metaphysical gap between God and His material Creation: if God is unchangeable, eternal, and incorruptible, matter is mutable, created, and corruptible; if God is simple and invisible, matter is plural and visible; if God is the source of all goods and virtues, matter (often) the source of evil and sin. The difference between the Creator and the Creation reached its peak with apophatic or negative theology, defining God by what He *is not* and taking the material world as the negative reference (Carabine 2015). Such abyssal difference between God and the world implied, in the limit, the denial of God's mythological attributes. As such, negative theology's *Deus Absconditus* could be considered as a theological open door to escape from literalist anthropomorphism. Nevertheless, rather than a simplistic division between positive and negative theology, it was common to find them combined to different proportions in most medieval theologies.¹⁶ There are unquestionable (although often neglected) elements of negative theology in both St. Augustine's (Geest 2011) and St. Thomas Aquinas' thought (Rocca 2008; O'Rourke 2016). But it is true that the negative approach is much more prevalent in the theology of Pseudo-Dionysius the Areopagite, who understood God in terms of "divine silence, darkness, and unknowing" (Dionysius the Areopagite. 2004; Rorem 1993). Augustinian and Thomistic theology, on the contrary, never abandoned the Biblical analogical anthropomorphism. This was understandably favored by Christian religious authorities, who preferred to give their blessings to theologies that, despite their "negative theological" elements, also underlined God's literal anthropomorphic character.¹⁷ Only by emphasizing God's personal character, able to bestow unthinkable rewards to the Church's followers, or horrific punishments to whoever broke the Church's rules, could Christian authorities maintain their political and sociocultural control over vast masses of people.

1.3 Return to *Physis*

As we have seen in the previous section, during the early Middle Ages (approximately from 500 to 1000 AD) the dominant worldview was based on Neoplatonic sources, mainly Augustine, Pseudo-Dionysius the Areopagite, Boethius, and few

¹⁶ Sharing similar theological problems and concerns, these combination between negative and positive theologies also took place in medieval Judaism and Islam: see Kars (2019) and Fagenblat (2017), respectively.

¹⁷ The recovery of God's anthropomorphic attributes was achieved through cataphatic theology, which sought to understand God in positive terms, emphasizing the divine attributes that we can find through the Revelation.

other Latin writers. Between 1000 and 1200 AD, approximately, the surviving texts of Aristotle and other Greek and Islamic thinkers were translated to Latin and reintroduced in the West. This resulted, along with the raise of the universities and the increasing demand on technical expertise in the growing cities, in a vigorous revival of learning in the West. Paris, Bologna, Oxford, and other universities became centers of intellectual activity, vivid discussion, and research. A new movement emerged aiming at blending Christian theology and Aristotelian philosophy. At the beginning of the so-called high Middle Ages (1200–1400), this movement had succeed thanks to the efforts of Albert the Great, Thomas Aquinas, and many others.

As soon as the main texts of Aristotle started to circulate, Robert Grosseteste (1168–1253), first chancellor of Oxford University, wrote several important commentaries on various books of Aristotle where he emphasized, among other things, the methodological aspects of the inquiring of nature and the importance of mathematical thought. He tried to harmonize Aristotelian empiricism with Platonic mathematical approach. Doing this, he offered one of the first explorations of the basic elements of what later would be called the “scientific method” (see Grant 2001; Lindberg 2007). Grosseteste was the first scholastic who understood the double path for scientific thought: generalize from particular observations to a universal laws, and then the reverse path: deduce from universal laws the forecast of particular situations. In addition to that, he stated that these two paths should be verified—or invalidated—through experiments. Grosseteste placed great emphasis on mathematics as a means of understanding nature and its research method contained the essential basis of the future experimental science.

The program of Grosseteste was continued and expanded by Roger Bacon (1220–1292). Bacon was one of the first to lecture on Aristotle natural philosophy in Paris, around 1245. He gave a special attention to the importance of experimentation with the aim of increasing the number of known facts about the world. He described the method of the natural philosopher as a repeated cycle of observation, hypothesis, experimentation, and then the need for independent verification. Bacon recorded how he conducted his experiments by giving precise details so that others could reproduce the experiments and test the results—that possibility of independent verification is a fundamental part of the method of the contemporary scientist.

Oxford scholars adopted the concept of matter given by Aristotle, i.e. hylomorphism, which conceives cosmic beings (*ousia*) as compounds of matter and form. Actually, the use of Latin word *materia*, to design Greek word ὕλη (*hyle*), “wood” or also “that out of which”, was introduced by the Scholastics. It derives from the root *ma*—“to make”. Thus *materia* having a common root with *mater*, “mother”, seems to be adequate word to render the original Greek term. Then, through the high Middle Ages, the term *materia*, matter, corresponded to the correlative of *form*: that which receives form. *Prima materia*, pure matter, correspondingly, cannot exist. Whatever is, is in one form or another.

Because of their Neoplatonism, inherited from a large tradition coming back to Augustine, the Franciscan scholars regarded that all activity source of being was in the forms, and matter was merely inert and passive (an understanding that we have explored in the previous section). The reversal of this Platonic and Neoplatonic

position would prove to be of the greatest importance for the reemergence of materialism after the Scientific Revolution. Roger Bacon, in particular, conceived matter as having its own *essence*, and hence being in principle *active* independently of form. The critiques of the traditional understanding of matter as passivity and negativity implied a criticism not only of Platonism and Neoplatonism but also of some Aristotle's tenets. The concept of motion of Aristotle became soon under attack.

The first to seriously questioning of the Aristotelian ideas about natural motion was made by the sixth-century Alexandrian Neoplatonist John Philoponus (490–570), who objected the suggestion made by Aristotle that when a projectile is launched, the medium imparts a force that sustains the projectile against natural motion (vertical, in the sub-lunar region). The medium receives the force from the thrower. Philoponus claimed that, actually, the medium serves as *resistance* to the movement, not a cause. If the projectile continues its motion against the natural movement is because it has an *impetus* (a kind of driving form), that is acquired by the projectile and remains until the medium dissipates it. These ideas were developed by John Buridan (1295–1358), who used the term “impetus” to refer the internal impressed motive force of a body. His ideas were influential in Galileo's treatment of kinematics during the seventeenth century. Buridan went so far as to claim that the impetus, which are corrupted by the resistance of the air, can be measure by the velocity of the projectile and the quantity of matter in it. However, it must be emphasized that Buridan, contrarily to Galileo centuries later, still was working within the Aristotelian paradigm, since he conceived his impetus as *causes* of motion, and not as the modern concept of *inertia*.

Why did it take more than two centuries since these first criticisms to Aristotelian physics to finally dropping the Ancient worldview? The answer is complex, as any answer to any question in the history of ideas. Negatively, a prominent reason seems to be the advent of the Black Death. It was the largest pandemic ever, it whipped out half of the population of Europe, and destroyed the material basis on which the revival of the learning in the West grounded. Positively, the reasons why this change did eventually occur might be linked to an equal disruption in the material conditions of philosophical and scientific work: the discovery of a new world.

1.4 A New World

Enlightened interpretations of the early modern period as the dawn of reason were well alive throughout the twentieth century, even if at times they took the negative overtones of Max (Weber's 1946[1918]) thesis of the “disenchantment of the world”. These interpretations picture the Middle Ages as a dark period of ignorance and superstition brought to an end by Renaissance humanism and its drive towards naturalization. We have seen already how this interpretation misses the late Medieval rise of empiricism and the timid recovery of Ancient materialism. The second part of the enlightened story also misses a key development: the blossoming

of theological and spiritual explanations of natural phenomena in the early modern period. True, the fall of Constantinople in 1453 meant an unprecedented migration of Eastern wisdom to Europe. This included translations of Ancient philosophy which, added to those facilitated by the circulation brought about by the Crusades, helped triggering the humanist inquiries of Pomponazzi (1462–1525), Machiavelli (1469–1527) and others for whom the supernatural had little place in human and natural history. But we should not forget that in the world of early modernist thinkers coexisted human powers with magical and demonic prodigies, witchcraft artifices, and a myriad of theological portents and miracles (Daston 1991; Clark 1997; Vermeir 2011).

Rather than an abstract philosophical impulse towards naturalization, it was a political context of competition between incipient empires and nation states and an economic one of rising markets what came to transform and question the ancient wisdom transmitted in universities. Regarding notions of matter, artisans busy in their workshops bending, dying, heating and smashing stressed its many potentialities (Smith 2004). While rather an unusual figure, Paracelsus (1493–1541) serves as a yardstick of his contemporaries' complex conception of nature. Educated in Basel, Vienna and Ferrara, his studies of theology and medicine included the latest Pythagorean and Neo-Platonist additions to the Renaissance corpus. An avid traveler in Europe, he combined the practice of medicine and alchemy with a growing theoretical corpus which moved fluidly between natural philosophy and magic. His materialist interpretation of hermetic monism paid close attention to how natural elements interacted with one another, but also postulated a pantheistic universal continuum connecting all beings (Weeks 1997). In the sixteenth and seventeenth centuries, alchemy and “chymistry” (a practical and theoretical precedent to modern chemistry) constructed a theological frame for an experimental practice which combined and transformed natural elements in ways that opened up the possibilities of matter (Newman 2006).

The importance of this chemical atomism for conceptions of matter in the next two centuries cannot be overemphasized. The reason is not its scientific accuracy, since Dalton's atomic theory of the nineteenth century was nothing like sixteenth and seventeenth century versions (it relied on the complete reorganization of the elements conducted by Lavoisier and others at the end of the eighteenth century). The significance of the theory of corpuscularism put forward by alchemists (and later adopted by mechanical philosophers) lied in its opposition to the Aristotelian distinction between matter and form. In Aristotle's hylomorphism, form was imposed onto passive and uniform matter. Albertus Magnus and Thomas Aquinas endeavored to Christianized Aristotelian hylomorphism in the search for a metaphysical foundation for the otherwise mythological Catholic doctrine of transubstantiation. In the Eucharistic miracle, Aquinas argued, the bread and wine became prime matter, pure potentiality, while their form was (by God's will at the consecration) the very body and blood of Christ. God is here a *Dator Formarum* of a prime passive matter. Alchemical elements, on the contrary, were imbued with form (with activity, virtues and sympathies). In the context of Reformation, when the Church championed a literalist reading of transubstantiation, atomism posed a

challenge to Thomist interpretations (Newman 2006). Even the Jesuits had to turn their natural philosophy upside down to face this experimentally raised criticism (Feingold 2003). Francisco Suárez (1548–1617), the great Christian metaphysician of his time, came to deny in his *Disputationes Metaphysicae* (1597) the possibility of a prime matter completely separated from form—he did admit the possibility of form completely separated from matter, and he called it spiritual substance (Bueno 1990a).

Far from a lineal progression towards materialism, numerous steps back and meanders shaped the modern materialist philosophies before they crystalized in the seventeenth and eighteenth centuries. A turning point was 1492. While Columbus did not realize the enormity of its finding, short after his voyage European cosmographers working for the Spanish crown recognized the discovery of a new world (Portuondo 2009). As the American continent was defined, enlarged and redefined along the sixteenth century through cartography and conquest, a plethora of new entities completely reshaped the map of knowledge. The first victim of the new continent was the Ancient Ptolemaic world map. Already under question by Portuguese voyages south of the Equator, the Magallenes-Elcano 1519–1522 voyage of circumnavigation was explicitly perceived as the destruction of the Greek known-world, of the Christian medieval maps, and of the learned disputes at universities over whether the four Aristotelian elements formed four distinct spheres or whether they were completely mixed in the sublunar world (Camprubí 2009). The road to Copernican heliocentrism (and thus to the new physics of Galileo Galilei, 1564–1642) was beginning to open.

As Charles V adopted the motto “plus ultra” to signify his empire’s going beyond the old world, José de Acosta and others utilized the vernacular to declare that their knowledge made the Ancient obsolete (Insua 2018). Geographical discoveries and specially the voyage of circumnavigation were perceived as examples of the new power of science and boosted confidence in the possibilities of “discovery” Bueno 1989; Grafton 1992; Wooton 2015. Trigonometry, the theory of the sphere and astronomical navigation contributed to the emergence of an age of global empire and knowledge in which rulers were quick to recognize the political import of maps, building techniques and learned schools. This imperial contest, moreover, was at the heart of the religious reformation movements which resulted in the creation of protestant and national churches in northern Europe. It also triggered a global commerce in which companies and state officials needed to develop complex bureaucratic structures spanning entire continents.

Other areas of knowledge were no less shaken by navigational voyages than spherical geography. With little exaggeration, historians have spoken of the “discovery of mankind” (Abulafia 2008). Ethnography was sketched as a discipline as new peoples unimagined by the biblical teachings of the Church were recognized as humans and their languages and costumes studied and recorded (Padgen 1982; Davies 2016). The heated Salamanca disputes around the theoretical and practical consideration of the newly encountered peoples were among the landmarks of the second scholasticism, including figures like Suárez who sought to adapt Christian metaphysics to the findings of the era. This philosophical movement devoted great

efforts to counter the reformists theses and redefine the relationships between political and religious power. In the process, they took theology to its utmost refinement, but also made evident the internal contradictions of the spiritual metaphysics of the free soul and the infinite creator, as with the late sixteenth century free will controversies between Dominicans and Jesuits (Hevia Echeverría 2007).

Natural history and medicine also entered into uncharted territories. The works of Fernández de Oviedo and other royal botanists pictorially recorded the thousands of new botanic species found in the new world, putting into perspective the *materia medica* written before then (Barrera-Osorio 2007). From El Escorial to the Ashmolean Museum in Oxford, cabinets of curiosities spread throughout Europe, containing all kinds of wonders and effectively shifting the focus of natural philosophy from the universal to the particular (Daston and Park 1998: 135–172; Grafton 2000).

The experimental overcoming of the Ancients was formalized institutionally first in the Portuguese Casa da India and then in the Spanish Casa de Contratación and, explicitly modeled after the latter by the likes of Francis Bacon (1561–1626), the Royal Society (Pimentel 2001; Cañizares-Esguerra 2006). Bacon, famous for theorizing the experimental turn that others were putting into practice, captured his times' interest in rare and singular phenomena in his "tables and arrangement of instances" of "natures" (in the plural) to capture the plurality of bodies and virtues accessible only by bodily operations (Klein 2008). Like in the explorers' *relaciones geográficas* (the thousands of official reports of the findings from remote lands), the world was a pluralistic wealth of entities waiting to be untapped by unimpeded natural philosophers whose task was to push nature to its very limits (Ashworth 1990; Pardo J. 2002). The breaking of the old world required the constitution of a new one. While of course historical transformations are never so abrupt, finding the building blocks of this new world was the self-invested role of the great scientific and philosophical systems of the seventeenth and eighteenth centuries.

1.5 Materialism Crystallized

At the dawn of the seventeenth century, occult causes and spirits, demons and miracles were relegated to the margins of theology and natural philosophy. The retreat of animism (or popular spiritualism) from the philosophical debate was not the result of turning to Reason with a capital R. It was largely the outcome of the political vulnerability of the Roman Church and protestant communities, which had to measure their forces against imperial and city–state armies. In that context of upheaval, a natural order governed by universal laws regained political import (Daston 1991). Religious tolerance, where it existed, was an unintended consequence of the extreme religiosity of the reformation and counterreformation movements and of the relative political weakness of the different churches. This helps explain the rise of the political theories of father Juan de Mariana (1536–1624) or Thomas Hobbes (1588–1679), the latter explicitly grounded in a materialist

interpretation of Galileo's new physics. By the mid of the century, explanations of movement could no longer invoke action at a distance nor antipathies or sympathies; they were expected to refer to mechanistic explanations of physical contact among bodies (Meli 2006) or at least occult attributes as in the case of Newtonian gravity (Henry 2008).

Hobbes's philosophy deserves a special place in any history of materialism. And yet, his materialism had peculiarities that puzzled both readers and censors. Hobbes combined philosophical materialism with Christian belief by holding that God is corporeal. He challenged readers of the Bible to find a passage that says that God is incorporeal. He even declared Hell and Heaven to be real and corporeal. These theses, which have puzzled scholars to this day, may well indicate that Hobbes was in truth a crypto-atheist who put forward contradictory speculations on God and the Bible to avoid censorship. But perhaps we should take it more seriously. Let us not forget the important tradition of theological materialisms, from Thales, Heraclitus, the Stoics, Epicurus and Lucretius to Spinoza.

For Hobbes, to be real is to be corporeal. And to be corporeal means to have dimensions and quantity and move, i.e. to be is to become in a spatial and quantitative way. Within this general framework, Hobbes's ontology of matter defends that matter is made of a spatial and moving continuous stuff. Different densities of matter correspond to different composition of materials. Mathematics, and specifically geometry, is the result of an abstract idealization of matter's properties. Without geometry, we would be unable to understand the nature of matter. Matter's movements are legally determined by objective causality: there is no room therefore for real magic and miracles. It is clear that Hobbes was pushing the mechanical science of its time to its ontological limits.

While physicists often get the credit for the rise of mechanic philosophy, it was physicians who started to think seriously about mechanical reductions of the soul. Vesalius (1514–1564), imperial doctor with Charles V and Philipp II, did much to reconstitute the value of anatomy, autopsies and a mechanical vision of the body with his *De humani corporis fabrica* (1543). In 1554, the physician Gómez Pereira (1500–1567) argued that animal organisms functioned like machines (Gómez Pereira 2000). He did so partly as a response to a recent debate initiated in Italy by Pomponazzi's *De Immortalitate Animae* (García Valverde and Maxwell-Stuart 2019, p. 22–55), and through the following *reductio ab absurdum*. Despite Aristotle, it is impossible to separate sensation and intellect and to restrict the former to humans, because if sensation is to serve volition it needs to be accompanied by some sort of intellectual judgment that enables animals to distinguish between those perceived objects that they want for food, shelter or mating from those perceived objects that they need to avoid or run from (as we mention below, Schopenhauer embraced this first part of the argument). But recognizing intellectual abilities to the brutes would tantamount to acknowledging they have something very akin to a spiritual soul, and this is absurd and irreligious. The only solution Gómez Pereira could think of was denying animals had sensations and will and assuming their movements were the result of physiological resorts like those of a clock or a magnet (Pereira 2019[1554]).

Gómez Pereira's solution resembles the sharp distinction introduced some decades later by Descartes (1596–1650) between material things (*res extensa*) and thinking spirits or souls (*res cogitans*). Descartes was also familiar with the physiology of the animal and the human body, as with the machines and automata that proliferated in the early modern period. While both authors sought to preserve the immaterial immortality of the Christian soul, their physiological mechanics paved the way for the physical materialisms of the eighteenth century. Nonetheless, between the two thinkers important scientific developments had greatly changed understandings of matter and its powers. What physicists added to the early physician's mechanics was mathematization. We should avoid exaggerating the role of mathematical sciences in the rise of materialism. Kepler applied conic theory to retool the orbits of planetary movement. And Galileo sought to find abstract mathematical relations between the phenomena he observed and experimented with. But while Galileo's scientific mechanism was intended as a rebuttal of Aristotelian physics, it did not intend to pose an ontological alternative to the world of final causes which characterized Aristotelian philosophy. The second, more ambitious, project was what Descartes attempted to do with the mechanical philosophy, first put forward in his 1644 *Principia Philosophiae*.

Descartes's Paradox: From Radical Theological Spiritualism to Crypto-Mechanistic Materialism?

In 1641 Descartes published the *Meditationes de Prima Philosophia*. This work would become the basis of modern philosophical spiritualism. The "systematic doubt", with clear if unacknowledged precedents in Saint Augustine, led Descartes to question everything except the act of doubting itself. This demonstrated, he famously concluded, the indubitable existence of the ego cogito. The world we see and touch, the people with love or hate, could be illusions. The thinking mind cannot. This argument became the solid rock on which modern philosophical spiritualism was built. The human mind that emerges from this argument is a sort of disembodied reasoning engine without emotion and motivation—a reductionistic which seventeenth century "computationalism" would take as a precedent to its arguments that mental processes are just computations. At this point in Descartes's philosophy, the thinking mind does not occupy any space within the body.

Descartes's spiritualist argument, moreover, was explicitly theological. While a malicious demon could be creating the illusion of the external world, it could not conceal from us the fact that our thinking exists. Accepting the ontological argument, the thinking mind demonstrates the existing of God as the most perfect entity that can be thought. But it is through faith that we know of God's goodness, which then allows us to infer that the external world we think in our thoughts does actually exist beyond illusions. The soul and God take ontological and epistemological precedent over matter.

This most perfect argument for theological spiritualism, however, contained the dangerous seeds of philosophical materialism. Descartes's idea that the existence of the external world is, as a last resort, supported on faith strongly influenced later

philosophers, from Malebranche to Kant and Gramsci. But it also introduced a split between spiritualism and theism. God's omnipotence would even alter mathematical truths, but it could not lie to us about the fact that we and our thoughts exist. God was no longer necessary to proclaim the reign of the spirit. This belief in the autonomous existence of human spirits would later become central to both radical empiricism and German idealism. But it would also be used by philosophical materialists who, as we show below for authors like d'Holbach, pointed to the contradictions of Christian ontotheology (Bueno 1972).

Even more important for us are the developments of Descartes's thoughts on matter, in particular the distinction between primary and secondary properties and the mechanistic view of matter. The idea that the senses conceal from us the true nature of reality had been present in the Western tradition since the times of Greek presocratic philosophers. It became central for some early modern scientists, particularly Galileo. Physics, as natural philosophy, could reveal the primary properties of things. Following Galileo without quoting him, Descartes contended that our senses deliver only superficial and distorted appearances. But, unlike Kant, who would later radicalize Galileo's and Descartes's idea by stating that the knowledge of things in themselves is impossible, Descartes went after real things and their primary (or mind-independent) properties. The secondary properties of the things we perceive would later be known as qualia. For spiritualism, qualia reside in a supernatural soul; for materialism, in the activity of the nervous system. But in both cases the universe appears as colorless, soundless, insipid, and inodorous. The distinction between primary and secondary properties would be challenged by both phenomenologists and physicalists alike. Phenomenologists, like Hume and Berkeley, argued that there are no reasons to believe in the existence of primary properties. Physicalists, in turn, became unable to account for secondary properties (a problem still open today, as later sections of this chapter discuss).

For Descartes, the distinction between primary and secondary qualities opened the very possibility of the mechanical worldview. Together with other scientists and philosophers of his time, he moved away from the Aristotelian physics and ontology of matter. Physics was now the science of matter in motion. His *Le Monde* (1664 [1633]: 7–10) starts with the discussion of the difference between our sensations and the things that produce them. The primary properties of material things could be reduced to figures et mouvements, i.e., to mechanical entities and processes. Descartes had first divided reality into three main domains: God, as an infinite spirit, the finite human spirit (*res cogitans*), and matter (*res extensa*). In later periods of his life, *res extensa* seemed to displace the key roles Descartes had earlier assigned to the spirit.

This shift is even more evident in Descartes' posthumous treatises on man and world (*Traité du Monde* and *Traité de l'Homme*). These works accounted for everything in the world by mechanistic causes. This included the highest functions of the human body as well as miracles. There was little room for the human soul understood in supernatural terms. Thus, in his *Treatise on Man*, Descartes wrote: "I should like you to consider that these functions [including passion, memory, and imagination] follow from the mere arrangement of the machine's organs every

bit as naturally as the movements of a clock or other automaton follow from the arrangement of its counter-weights and wheels.” Whereas the *Meditationes* defended a spaceless *res cogitans*, Descartes later works physically located it in the pineal gland. The strong spiritualist rhetoric of his early *Meditationes de Prima Philosophia* was therefore totally abandoned. Fearing the power of the Church, Descartes did not dare to publish his treatises while alive, and they have been usually overlooked by the usual histories of philosophy (they were translated into English only three centuries later). Nevertheless, after his death, these posthumous works enabled mechanistic readings of his more famous works, revealing the true rich of his *Principia Philosophiae*.

He had there proposed a metaphysics in which all movement occurred by physical contact in a microscopic plenum and according to three laws justified on the grounds of God’s immutable nature. Despite Descartes’s attempt at mathematical formulations, his mechanistic philosophy was built on metaphysical and theological grounds (and through analogies to actual machines) very different from the mathematical physics of Galileo’s mechanics (Meli 2006, p. 135–144). The same is true for Gassendi’s (1592–1655) mechanical philosophy, which unlike Descartes’s plenum recovered the Ancient theory of atoms and void (a possibility reinforced by Torricelli’s experiments with the vacuum). But mechanistic reductionism would prove to be extremely successful in modern natural sciences (although, as discussed later, nineteenth century field physics and thermodynamics would show mechanics is only one chapter of physics). Moreover, it had opened the way to deist visions of God as the maker of a material mechanism whose functioning did not depend on His providence but on immutable and deterministic laws. This was only a step away from materialist atheism.

The Power of Matter

Alongside mechanism, the study of matter and its properties also continued in the great systems of natural philosophy, which nevertheless were often theologically framed and explicitly anti-materialists. A case in point is the experimentalist Robert Boyle (1627–1691), who popularized two terms that he was careful enough to separate: “corpurcularism” and “materialism” (a term coined only some years before Boyle used it and helped spreading it). His defense of the former was part of his attack on the latter, and it is no coincidence that the materialist Hobbes was among Boyle’s greatest antagonists (Shapin and Schaffer 1985). Boyle’s alchemical program set out to demonstrate that matter was passive and brute without a natural order which depended entirely on God’s will.

Newton (1643–1727) is also a good example of the anti-materialism which often framed scientific mechanism. While he successfully completed, systematized, and universalized the new mechanical physics inaugurated by Galileo, it is well known that theology occupied a great deal of his energies (Westfall 1983). Moreover, inasmuch as active matter might have been an important unacknowledged “hypothesis” behind the action at a distance seemingly required by the universal law of gravitation, God would have played an important role in the philosophical

framing of the mechanics of the *Philosophiae Naturalis Principia Mathematica*'s mechanics (Westfall 1983, 646). Finally, while Leibniz (1646–1716) opposed Boyle's corpuscularism and Newton's views on space and time, he shared their dismissal of materialism in favor of a theological and spiritual ontology of self-sufficient but interconnected *monads*, conceived as centers of pure activity, a sort of middle way between mechanism and teleology in which God acquired the problematic status of a monad of monads; see Bueno (1981).

Spinoza (1632–1677) was a different story. His philosophy can be (and has been) interpreted both as pantheistic or as materialistic and atheistic, because the God that he equates to nature has none of the personal attributes of the God of ontotheology. Spinoza's "God, or nature" is infinite, absolute, necessary, and indivisible, but it has no personal or anthropomorphic characteristics. It is the very eternal necessity of the world to be. This can be better understood in light of Spinoza's attack on the Cartesian thesis that spiritual life is independent from organic life. The entire edifice of Spinoza's philosophy was based on the negation of spiritualism, even if it used schemes coming for Cartesian philosophy such as substance and causality.

But Spinoza's philosophy also avoided reducing the whole of reality to mechanically moving corpuscles. Reality or nature (the infinite necessary and indivisible "substance") works in Spinoza in different modalities, including extension and thought which are irreducible to one another but refer to the same nature (Peña 1974). If this is the case, then Spinoza would have been among the first and most sophisticated examples (although not one without problems and contradictions) of a non-reductionist and non-monist materialism of the kind that would later flourish in the very different context of the twentieth century (see below). His political philosophy was no less impious than his ontology, and his *Tractatus Theologico-Politicus* (1670) confronted the providentialist supernaturalism with which most Christian and Jewish thinkers approached human and natural history.

Spinoza was certainly read as an atheist by many enemies and followers alike. The latter group became relevant when, early in the eighteenth century, non-theological interpretations of Newtonian mechanics proliferated both in England (with John Toland, 1670–1722) and in France (with Voltaire, 1694–1778). The latter utilized Newton's physics and John Locke's empiricism to construe scholastics as an strawman of religious fanaticism and announce a new era of lights. Libertine clandestine literature, which had been flourishing since the seventeenth century in works like the anonymous *Theophrastus Redivivus* and *Traité des Trois Impos-teurs*, deepened the mistrust of Christian spiritualism (Jacob 2019). Most French enlightened thinkers adopted a deist philosophy which removed most mythological attributes of God while preserving his personal nature as an architect and creator of the universe (Pascal famously dismissed this as the "philosophers' God"). But others openly embraced materialist worldviews without a place for God and the supernatural soul.

The Difficulties of Empiricism to Account for Modern Science

It is still common to associate the rise of modern empiricism with the development of modern science. The personal and intellectual relationship between John Locke (1632–1704) and Newton has often been invoked as proof (Ansey 2017). Newton published his *Principia* in 1687, and Locke was quick to review it in praise. Locke's monumental *An Essay Concerning Human Understanding* appeared only two years later, and it included some adaptations to Newton's *Principia*. However, the impact of Newton's *Principia* on Locke's empiricist philosophy was actually very limited (Rogers 1978). In the very general level of rhetoric, empiricist philosophers did indeed posit empirical observation and experimentation as the means to know the world. But in the more granulated level of epistemology, the incompatibilities between the two show the difficulties empiricism faces in trying to account for modern science.

In short, Newton's *Principia* analyzed some of the laws of motion that Locke's empiricism deemed unknowable. Locke embraced an atomistic and mechanistic ontology of matter. He also defended the distinction between primary and secondary qualities. In the list of primary qualities, he included size, shape, motion, number, and solidity. That is, he rejected the Cartesian definition of material body as simply extended, arguing that bodies are both extended and impenetrable/solid. This was his tribute to Boyle's atomism. But all this was hardly compatible with an empiricist epistemology that held that our only source of knowledge is either directly sensation or reflection upon sensation. This led Locke to devise his own theory of matter and of our knowledge of it.

Moving away from Descartes's innate ideas, Locke defended that we are born as blank slates. Thanks to the process of empirical knowledge, we can have simple or indefinable ideas (such as our notion of blue) and complex ideas (such as our idea of a country). The empiricist theory of association opposed others available at the time. The neuroanatomical work of Doctor Thomas Willis (1621–1675), for instance, identified mental activity with brain processes. In contrast, Locke held that although our ideas of secondary qualities are caused by primary qualities, that mechanism is mainly unknown. After all, how the size, figure and motion of particles could cause any sensation in us? And, what's even more puzzling: what is what underlies beyond primary qualities? Although Locke had rejected much of Aristotelian ontology, he still held that qualities are always qualities of something. And that "something" behind our knowledge of matter is called "substance" in Locke's metaphysics. Locke thus postulated subject-independent substances and causal processes, but he declared them unknowable.

Locke's empiricism inspired the development of much of modern psychology, often opposed to empirical studies of the brain, and of later empiricism, particularly that of David Hume (1711–1776) and George Berkeley (1685–1753). Despite contemporary advances in the physical and other sciences, Hume deepened Locke's divide between knowledge and reality. His philosophy was at odds with the very existence of matter. Taking the empiricist premise to its most radical conclusion, Hume saw no reasons whatsoever to believe in the existence of independent

substances that are the cause of the phenomena we perceive. Subject-independent substances and causal processes might exist, sure, but they might as well be just the products of human imagination. A rose, for instance, is the bundle of its properties (size, color, smell. . .). We do not have any good reasons to hold that behind such bundle of qualities there is a substance that supports them. As Bunge (2006) has noted, Hume denied the epistemological possibility of knowing anything other than subjective phenomena “at a time when physicists and chemists were studying non-phenomenal facts such as planetary orbits, imperceptible gases, and invisible chemical reactions. It is not that Hume was unaware of these novelties: He rejected them explicitly because they contradicted phenomenalism.”

Hume’s phenomenalism led him very close to subjective idealism, in which we do not have any reasons to hold the belief in the existence of absolute realities and causality beyond human appearances. Therefore, Hume reduced matter to secondary qualities, approaching subject-independent qualities with strong skepticism. Hume’s critiques of the principle of induction also contributed to his rejection of universal natural laws. As it has been pointed out many times, Hume was obviously right in holding that the leap from “some” to “all” is logically invalid. Nevertheless, he went too far in denying the subject-independent objectivity of connections, from structures to causality.

The rejection of objective causality and structural processes in matter led Hume to a God-less contingentism. The picture of an almost phantasmagorical world whose only stability is given by human finite, precarious and imperfect psychology was a bad companion as a philosophical presupposition of natural, social, and biosocial sciences, let alone of philosophical materialism. Nevertheless, and paradoxically, Hume’s “immaterialism” can also be seen as a significant episode for the history of materialism through his critiques of the notion of substance. Buddhism has defended for millennia the enigmatic idea (for a Western mindset) that emptiness or nothingness fills reality. But the Buddhist nothingness is not the absolute privative nothingness of Abrahamic creationist ontotheology; rather, it points out at the insubstantiality of things as something dynamic and real. Things do not have any substantiality because everything is dependent and impermanent (in contrast with the dependence and permanence attributes of traditional substances). Hume held a very similar idea through his “bundle theory”: like in Buddhism, everything, from stars and mountains to our “ego”, is an impermanent and dependent aggregate of changing properties or qualities (see also Borges 1989[1952] for his poetic “new refutation of time”). The essence of being is becoming: an idea already held from Lao Tse, Heraclitus and early modern materialist philosophers. But Hume went beyond through his thesis that everything (and therefore matter) is composed of transient aggregates. That means that we cannot hypostatize anything in reality (including properties), an idea key for some versions of materialism, such as current discontinuous materialism and some versions of systemic materialism (see Pérez-Jara’s chapter in this volume).

Berkeley’s subjective idealism took empiricism to its last consequences. A bishop, Berkeley explicitly rejected the existence of matter and argued that everything in the universe is a set of temporally discontinuous appearances created

by God: things only exist beyond human perception inasmuch as God perceives them. But the divine perception has little to do with human epistemological apparatus, so cosmic entities, as we understand them, cease to exist when there are no finite souls perceiving them. Berkeley's epistemology was considered too radical by the majority of Christian scientists and philosophers. Our point here is that Hume's attacks on Christianity should not conceal that the incompatibilities of Hume's philosophy with modern science and materialism are comparable to those of Berkeley's philosophy. British empiricism was incompatible with much of physics, chemistry, biology and psychology. For Hobbes, the substance behind the mind is unknowable; for Hume, in all likelihood the brain is just a bundle of empirical qualities, just as any other object we perceive; for Berkeley, the brain is an idealistic appearance that only exist when we observe it. British empiricism played a propagandistically important role in emphasizing the importance of empirical knowledge and the rejection of innate ideas. But its large idealistic shadow opposed understandings of matter in terms of objective causal and structural legality.

Materialists Out of the Closet

Drawing on Hobbes' explicit but peculiar materialism, as well as from Descartes's and Spinoza's crypto-materialisms and from further scientific developments, thinkers like La Mettrie (1709–1751), Claude Adrien Helvétius (1715–1771), and Paul-Henri Thiry, the Baron d'Holbach (1723–1789) advanced strong materialistic agendas in the eighteenth century. These authors took to full consequence Hippocrates's and Galen's idea that the brain is the mental organ to proclaim the inexistence of the soul understood in supernatural terms. Their works were widely read despite being banned and, in the case of Helvétius's *De l'Esprit*, even burned publicly. Their materialism prefigured the monism of the nineteenth century materialists, aiming to explain all phenomena through "matter and motion".

La Mettrie explicitly rejected the existence of God and the truth of Christian dogma. Inspired by Descartes's posthumous treatises, La Mettrie followed a mechanistic view of matter rich in technological analogies on how human bodily physiology governs intellectual thoughts, feelings, and passions. The way such a machine would work occupied many of the scientists and philosophers trying to put up materialistic systems of the world in the centuries to come. This strategy was very different from d'Holbach's. One of the most active encyclopedists, d'Holbach drew more clearly from the chemical views of matter as active and divided into elements. In his key works *Système de la Nature* (1770) and *Système Social* (1773), he offered a full philosophical system, in which there was no place for supernatural or non-material beings. D'Holbach acknowledged that different types of matter had very different properties, arguing for instance that humans are made of a sort of thinking matter. This allowed him, moreover, to follow Spinoza's ethics by proposing and atheistic self-interest in preserving one's own life and that of (at least some) others (Thomson 2014). Not surprisingly, his works were banned in France.

D'Holbach's significance lies precisely in this merging of materialism with systemism. Departing from the individualist materialisms of the Epicureans, Lucre-

tious, and Hobbes, but also from Spinoza's holistic cryptomaterialism, d'Holbach held that material things form systems. These go from microsystems (like the organs of the human body), to the megasystem of nature or the world. This idea of system is crucial in the history of philosophy. It poses a middle ground between the excesses of individualism/atomism and those of holism: a system has, among other dimensions, components (overlooked by holism) and a structure (overlooked by atomism). Nevertheless, and despite these precautions, d'Holbach did hold a holistic notion of causality very similar to Spinoza's. Everything is connected with everything else causally from eternity. Thus, reality's main dimensions are materiality, systemicity, and causal determinism—a view that would have important followers among nineteenth century scientists and philosophers of disciplines as diverse as physics, biology, sociology, and history.

D'Holbach philosophical atheism is also worth noting. While d'Holbach is amply recognized as an atheist by both friends and foes, an aspect of his atheism has not received sufficient attention. According to his *Système de la Nature*, the very idea of God is a pseudo-idea, a “patchwork” composed of contradictory attributes: immutability is incompatible with the divine will and providence, infinity is only compatible with pantheism, and so on. The Abrahamic ontotheological God is thus ontologically impossible. This is a step further from the existential atheism that contends that God is a possible being but does not exist. We could call this structural atheism in contrast with the postulatory atheism of so many atheist philosophers, from Nietzsche to the so-called “New Atheists”, such as Sam Harris, Richard Dawkins, Daniel Dennett, and Christopher Hitchens.

Importantly for this chapter, one of the earliest mentions in English of the phrase “philosophical materialism” occurred in 1808 in an encyclopedic article about La Mettrie which appears to seek reconciliation: “philosophical materialism is not necessarily connected with irreligion or the disbelief of a future state” (Aikin et al. 1808: p. 70). Around the same time “*matérialisme philosophique*” appeared in French in a translation from the German *Geschichte der neuern Philosophie* (1800–1804), written by Jean-Gottlieb Buhle. It was also used in reference to La Mettrie's project of naturalization of the soul (Buhle 1816, p: 225).

That materialism was now recognized as philosophical may have to do with the recognition of its metaphysical stances beyond the scientific discussion, a separation we already saw in an incipient form when discussing seventeenth century mechanistic worldview. Some of the great philosophical systems of the nineteenth century would still consider science and metaphysics as part of the same project (particularly for the Germans, “*Wissenschaft*” was an encompassing enough concept). But as the eighteenth century was coming to an end and the number and complexity of scientific disciplines were multiplying, natural philosophy was beginning to break apart into two distinct endeavors: science and philosophy. The professionalization of the scientist as distinct from the philosopher was certified by Whewell's coinage of the word in English (even if the crystallization of science, philosophy, and religion as distinct enterprises was not complete until the late nineteenth century; Harrison 2015). While recognized as a different endeavor, philosophy still needed to be very attentive to the results that scientists were obtaining in their voyages, workshops,

and laboratories. The next two sections deal respectively with the philosophy and the sciences of the long nineteenth century, in which both the notion of matter and philosophical materialism underwent unexpected transformations.

1.6 From Modern Idealism to Karl Marx's and Engels' Dialectical Materialism

The institutionalization of modern philosophy was not about returning to Greek and Roman philosophy. Our thesis here is clear: without Christian metaphysics, modern philosophy would not exist. This is most evident for idealism. Christian ontotheology had taken the hypostatization of psychological life to proportions without precedent, at least in the Western world. The weakening of the Ancient Regime opened the way to attacks on Christian metaphysics and the rise of philosophical materialism. But thinkers moving away from medieval philosophy were transforming ontotheology, rather than ignoring or completely rejecting it. Christian theological ideas were secularized. Take for instance David Hume (2000[1739]) who, like Buddha had done millennia earlier, denied the substantiality of the ego and criticized the belief in miracles, clearly contradicting traditional Christian anthropology and theology. But the opposition was at times more apparent than effective. By rethinking causal connections in subjective terms, for instance, Hume was secularizing Christian doctrines of causality, such as the ones held by occasionalism. The same goes for the links between Hume's contingentism and that of the theologies of Duns Scotus, Occam, Luther, and Descartes (Pérez-Jara 2014).

Modern idealism in general, and German idealism specifically, emerged as one of the most important products of a historical process of secularization. The medieval understanding of God as *dator formarum* of the world became Kant's transcendental consciousness, Fichte's pure Ego, Schelling's Absolute, Hegel's absolute spirit, and Schopenhauer's Intellect. The idealist philosophies of these five thinkers, after all, represent softer versions of the hypostatization of the psyche exercised by Christian metaphysics (still very present in early modern thinkers such as Descartes, Malebranche, Berkeley, and Leibniz).¹⁸ This section explores their views of nature as well as their lasting influences.

Using the terminology of speculative realism, we consider modern idealist systems of metaphysics to be "correlationist philosophies" (Harman 2009, 2011; Bryant 2014). That is: philosophies according to which everything we can talk or think about only makes sense in a correlation with a subject. In this gen-

¹⁸ Hume's (and, later, Stuart Mill's) psychologism is different in that it can be considered an even softer version of this hypostatization of the psyche. Both authors downplay the organic and operational side of human existence, along with reducing abstract concepts, ideas and relations to psychological processes. But the independence of the mind respect of the nervous system is not held; it just suggested as a possibility.

eral classification, weak correlationists postulate the existence of an unknowable absolute reality that exists outside the correlation: that would be Kant's and Schopenhauer's positions. On the other hand, strong correlationists would deny such absolute independent reality from human subjectivity: it would be Fichte's position. Schelling's and Hegel's stances deserve more nuances, as we will see. Let us now begin by exploring Kant's "transcendental idealism".

Kant's Transcendental Idealism

Kant (1724–1804) famously credited Hume for waking him up from his "dogmatic dream" of taking metaphysical knowledge of God, the world, and the human soul for granted. Reading of Hume convinced Kant that there is a significant hiatus between human experience and reality as it is in itself. But then, he asked, what is the difference between absolute reality and the phenomena we experience? And, what are the main epistemological structures and processes that allow human experience and knowledge?

Kant spent many years developing his theory of knowledge and science, which he presented in the two editions of his *Critique of Pure Reason* (1781, 1787). He offered "transcendental idealism" as some kind of middle ground between naive realism (that Hume had debunked) and Descartes's, Hume's, and Berkeley's forms of radical skepticism or idealism. Kant's transcendental idealism searched for the conditions of possibility of human knowledge in general. Such conditions of possibility were not to be found in empirical subjects, which are already part of the world of human experience. Rather, they were transcendental/pure/a priori. Kant followed here Descartes' spiritualist *ego cogito* to postulate a "transcendental consciousness" which epistemologically constitutes the world of human experience.

Kant's epistemology had an immediate ontological aspect. Concerning matter, it considered its dual ideal and empirical character in two main ways. "Transcendental Aesthetic" studies how transcendental consciousness puts space and time as a priori intuitions that make experience possible. Fused elements of both the Leibnizian "relationalist" and the Newtonian "absolutist" conceptions of space and time with his transcendental idealism removed matter's spatio-temporal properties from reality itself. "Transcendental Analytic", in turn, studies how the transcendental consciousness puts twelve categories as pure concepts of the understanding (*Verstand*).¹⁹ These categories work with the empirical data provided by the spatio-temporal experience (Kant 2008[1787]), but also they do not pertain to the "thing-in-itself" (*das Ding an sich*).

Thus, Kant's transcendental consciousness does not create the world of phenomena *ex nihilo* (Heidegger 1997[1929]). In a similar way as Plato's Demiurge,

¹⁹ Kant's pure categories of the understanding are: unity, plurality, and totality for the concept of quantity; reality, negation, and limitation, for the concept of quality; inherence and subsistence, cause and effect, and community for the concept of relation; and possibility–impossibility, existence–nonexistence, and necessity and contingency, for the concept of mode (see Kant 2008[1787]; Heidegger 1997[1929]; and Strawson 2018).

the transcendental consciousness “works” with a previous unknown reality, the mysterious thing-in-itself, or *noumenon*. This absolute reality is previous to human epistemological distortions. The difference between human knowledge and absolute reality was a key issue in modern Empiricism. But while Locke contended that substance and causality were attributes of an absolute reality, Kant attributed them to the transcendental consciousness, the realm of phenomena. And while Hume embraced radical skepticism, Kant declared the absolute existence of the *noumenon*. We will see in the sections dedicated to German Idealism how Kant’s position regarding noumenon’s existence and even causal powers is contradictory. While in several key passages from Kant’s *magnum opus* it seems clear that the noumenon is identified with the absolute reality behind the world of phenomena, there are, on the other hand, other no-less important passages in which Kant is explicit in that the noumenon is simply a concept that is the logical counterpart of the phenomenon, and that since categories have real application only on the latter, it makes no sense to attribute existence and causal powers to the noumenon / thing in itself. This continues being a controversial issue for Kant scholars. Here, our position is that the only way to solve this problem is either declaring Kant’s concept of noumenon as contradictory (which is the way chosen by German idealists) or postulating that maybe the concepts of “existence” and “causality” can be applied to the noumenon in an analogical, but not literal, sense. In any case, both options contradict the Kantian notion of noumenon as the absolutely unknown. For our purposes, it is important to stress that Kant explicitly affirmed that matter does not exist without the omnipresent transcendental consciousness. As such, his philosophy cannot be considered materialist. In our view, these are among the main Kantian ontological and epistemological ideas incompatible with philosophical materialism:

1. For Kant, there are no space, time, causality, etc., without the transcendental consciousness, and therefore without humans. This means that absolute reality is a-spatial, a-temporal, a-causal, and so on. On the other hand, the Kantian “transcendental deduction” of space, time, and the understanding’s categories is a witty spiritualist fiction.
2. The Kantian transcendental consciousness, even if not a psychological ego, is a disembodied psychological and logical activity. Obviously, this implies the hypostatization of human psychological and logical processes. But, from a materialist point of view, these processes cannot exist without physical, chemical, biological, and sociocultural entities.
3. Equally fictional for a materialist philosophy is Kant’s epistemological foundations of mathematics and empirical sciences (mainly Newtonian physics, since Kant paid much less attention to either chemistry or biology). These foundations are again transcendental and limited to phenomena and not to things in themselves.
4. Kant’s totally non-historical and non-sociocultural explanations of the origin of the ideas of God, world, and soul cannot be accepted either for any materialist philosophy supported on scientific knowledge.

5. Kant contended the ontological possibility of ontotheology's disembodied and immutable God through his thesis on the *intellectus archetypus*, capable of knowing the thing in itself. Considered such imaginary "nous" contradictory, the concept of thing in itself as "*noumenon*" would fade away.
6. Kant's spiritualism is reflected on his dualism between nature and freedom. The late Kant nuanced this dualism in the *Critique of Judgment* (1790), contending that nature produces self-determining organisms capable, like humans, of disinterested aesthetic pleasure (Kant 2007[1790]). But despite these nuances, the dualism nature vs freedom never disappeared in the Kantian system, since it was supported on the key epistemological and ontological dualism between phenomena and the *noumenon*.
7. Kant's thesis on the impossibility of metaphysical knowledge about absolute reality is not only antithetical to philosophical materialism; it is also contradictory within Kantian philosophy, as Kantian thinkers such as Karl Leonhard Reinhold (1757–1823), Salomon Maimon (1753–1800), Jakob Sigismund Beck (1761–1840), and Gottlob Ernst Schulze (1761–1833) pointed out: the thing in itself can only be thought through some of the understanding's categories, which should work exclusively for the world of phenomena.

Despite the above-mentioned incompatibilities with philosophical materialism in general, there are also important convergences between Kant's transcendental idealism and a materialist outlook. Let us point out some of them:

1. Kant criticized subjective idealism and argued for an "empirical realism" (Kant 2008[1787]). In Kant's philosophy, individual consciousness is not what constitutes phenomena, but a transcendental consciousness that is behind *both* material phenomena and empirical subjectivity. While transcendental idealism is non compatible with philosophical materialism, its critiques of subjective idealism are valuable.
2. In the world of phenomena made possible by the transcendental consciousness there is no room for supernatural events. Kant's philosophical denial of miracles, revelations, and prophecies brought him serious problems. If the *Critique of Pure Reason* had implicitly denied supernatural phenomena (for they are not allowed by the understanding's transcendental categories), in his book *Religion within the Boundaries of Mere Reason* (1793), Kant explicitly expelled supernatural phenomena from his interpretation of Christianity (Kant 1998[1793]). Kant's antisupernaturalist theses were perceived as too radical and dangerous. As a consequence, the book met royal censorship. Kant's attempts to skip censorship ended up in a royal order that required Kant never to publish or even speak publicly about religion (Pasternack 2013).
3. Although Kant maintained the ontological possibility of disembodied spirits (the divine and angelical "*intellectus archetypus*" able to know "the thing in it self"), he also held that human individuality is necessarily linked to space, time, and corporeality against radical animism and spiritualism.

4. Kant did not only criticize traditional metaphysical proofs of the ontotheological God; he also explicitly held that this God is a “transcendental illusion”, i.e., just a mere idea product of reason when it works without empirical material.²⁰

Fichte’s (Inter)Subjective Idealism

Kant influenced important German philosophers such as the above mentioned Reinhold, Salomon Maimon, Sigismund Beck, and Schulze. Nevertheless, the most important immediate successor of Kant was Johann Gottlieb Fichte (1762–1814). For thinkers such as Arthur Schopenhauer, Bertrand Russell, and Karl Popper, post-Kantian German idealism is mainly a philosophical fraud. According to Russell, for instance, Fichte carried “subjectivism to a point which seems almost to involve a kind of insanity”²¹ (Russell (1972[1945])). The insanity of Fichte’s philosophy meant for Russell that the German philosopher should only be considered important as the “theoretical founder of German nationalism”, but not as a pure philosopher.²² Naturally, if Russell’s opinion were right, the significance of Fichte’s philosophy for philosophical materialism would be null.

Against this radical opinion, we contend that, despite its undeniable philosophical mistakes, Fichte’s philosophy is much more than “insanity”. Russell did not even seem to notice that the fact that Fichte strongly believed in supra-subjective realities such as the German nation, to which mortal and finite individuals submitted to, shows that Fichte’s idealism was far from solipsism. As we will see, it sometimes even approached materialism in some important aspects.

The basics of Fichte’s epistemology and ontology can be found in his book *Foundations of the Science of Knowledge* (1794/1795).²³ In his epistemology, Fichte identified *Wissenschaft* (usually translated as “science”) with the highest form of knowledge. But rather than a science in its current sense, Fichte’s *Wissenschaft* is a pure metaphysical system. Within this general system, empirical sciences would be minor disciplines subordinated to the highest science: metaphysics. As such, Fichte was not particularly interested in those minor empirical sciences, which, of course, moves him away from a materialist approach. Despite that, Fichte did not use any anti-scientific rhetoric: his main enemy was “dogmatism”, identified with the worldview that holds that the ego is a derivative reality that comes

²⁰ It is well-known that Kant (2015[1788]) introduced this God again in the *Critique of Practical Reason* as a postulate for moral action. But this does not contradict that, from an epistemological point of view, Kant held that the Christian God was just an idea.

²¹ Russell (1972[1945]), p. 718.

²² Russell (1972[1945]), p. 718. Russell also contended that “Modern philosophy begins with Descartes, whose fundamental certainty is the existence of himself and his thoughts, from which the external world is to be inferred. This was only the first stage in a development, through Berkeley and Kant, to Fichte, for whom everything is only an emanation of the ego. This was insanity, and, from this extreme, philosophy has been attempting, ever since, to escape into the world of everyday common sense.” Russell (1972[1945]), p. XXI.

²³ Fichte’s *Wissenschaftslehre* was later reworked by Fichte in various versions. The most well-known version of the work was published in 1804, but other versions appeared posthumously.

from an absolute impersonal reality. Fichte explicitly identified “dogmatism” with “materialism”. Against materialism, Fichte, following Kant’s terminology, proposed critical philosophy as the main antidote.

In building his philosophical system, Fichte followed Kant in starting by an analysis of how human experience works. In every experience, Fichte thought, there is an objective side and a subjective side. The objective or material side is linked to necessity, whereas the subjective side is linked to freedom. This binary between necessity (matter) and freedom (the subject) was largely based on Kant’s philosophy. When we abstract the objective side, we have the Kantian “thing in itself”, whereas when we abstract the subjective side, we have a pure (disembodied) intelligence. For Fichte, absolute reality lies either in the objective side (the Kantian thing in itself) or in the subjective side (the pure Ego).²⁴ The first option is “dogmatism”, which, if coherent (Fichte held) always leads to “materialism”. The second, “criticism”, which Fichte identified with his own idealism, thus denying the Kantian *noumenon*.

At the end of the day, Fichte declared, the kind of philosophy people choose depends on the kind of person they are. Those willing to believe in the existence of freedom, will choose criticism; those trapped by fatalist ideas, will choose dogmatism. By opting for idealism, Fichte followed the ontotheological tradition that identifies the *ipsum esse* with the *ipsum intelligere*. But, unlike Christian ontotheology, Fichte’s pure Ego is not an immutable entity or a substance of any kind, but, on the contrary, a pure constituent activity (*Tathandlung*).²⁵ As such, Fichte’s pure Ego is only a “substance” in its etymological sense: the pure Ego, like Kant’s transcendental consciousness, is what *sub-stare* both the phenomena and the empirical egos (Fichte 2009[1868]).

Fichte was explicit in stating that empirical egos are not what constitute the world of phenomena. For that reason, identifying Fichte’s idealism with an insane solipsistic metaphysics is just a bad caricature. Empirical egos have a beginning and an end; they come and go: what remains is the activity of the pure Ego operating through the millions of empirical egos. Fichte dubbed “non-Ego” (*Nicht-Ich*) to the material reality constituted by the pure Ego’s activity. As such, Fichte’s view of matter remains prisoner of the traditional identification of matter with negativity and passivity. Within this traditional general conception of matter as negativity, one of Fichte’s original ideas was to also conceive matter as a set of obstacles to be overcome by subjects. Without confronting such material obstacles, Fichte contended, self-consciousness would be impossible.

Since for Fichte, Kant’s “thing in itself” was a redoubt of dogmatism, matter/non-Ego does not exist whatsoever without the pure Ego’s activity. For Fichte, like for

²⁴ That is, for Fichte, absolute reality cannot be (as Schelling will defend later) *both* subjective and objective.

²⁵ The concept of *Tathandlung* reminds of Husserl’s *Leistung*. But Husserl’s transcendental idealism did not deny the Kantian “thing in it self” as Fichte did; it just placed it between brackets: see Pérez-Jara 2014.

Leibniz and Berkeley before, there are only spirits in reality: what we call “material” is just a set of phenomena constituted by the pure Ego’s disembodied activity. Gustavo Bueno correctly referred to this radical metaphysical position as “exclusive spiritualism” (Bueno 2019).

Fichte’s idealism was immanent in that *nothing* falls outside the pure Ego. In the *First Introduction of The Science of Knowledge*, Fichte went as far as considering Berkeley’s material idealism as a form of (inconsistent) materialism, since it postulated God’s extra-subjective reality (Fichte 1982[1794]). From our perspective, Fichte’s pure Ego was, like Kant’s transcendental consciousness, a new secularized version of the Christian ontotheological God. But it was also a departure from that God. Fichte’s “God” is not the personal creator of medieval metaphysics. To begin with, Fichte’s idealism was an (inter)subjective idealism. Similarly to Edmund Husserl in the twentieth century, Fichte’s intersubjective idealism defended that there is no “I” without “you”. This situates Fichte among those who opened the door to the study of human nature and society supported on intersubjectivity, a milestone for the materialist understanding of human sciences. In his *Foundations of Natural Right* (1797), Fichte attacked the solipsism of Christian, Jewish and Islamic metaphysics, which explicitly conceived the possibility of absolutely individual and isolated egos and, in particular, of God’s absolute Ego (Fichte 2000[1797]). Because the ego always implies interactions with both the non-Ego (matter) and a plurality of egos, the ontotheological God is not ontologically possible for Fichte. Before the creation of angels and the world, God’s absolute ego does not have either “objective” obstacles to overcome nor other egos to interact with. The conclusion for Fichte (2009[1868]) is obvious: the traditional Christian God cannot be an “ego”. Furthermore, for Fichte an immutable Ego is also a square circle. Fichte’s identification of *being* with *becoming*, and the subsequent denial of the ontological possibility of the Christian God, is an important point of convergence with philosophical materialism.

Another convergence with materialism is Fichte’s early denial of supernatural phenomena. Fichte’s first published work was the *Attempt at a Critique of All Revelation* (2010[1792]).²⁶ In that same vein, in 1798 he responded to Friedrich Karl Forberg’s essay “Development of the Concept of Religion” with the publication “*Ueber den Grund unsers Glaubens an eine göttliche Weltregierung*”, usually translated as “On the Ground of Our Belief in a Divine World–Governance” (Bowman 2016). Fichte’s secularized and rationalist metaphysics led to accusations of atheism and a heated dispute with, among others, Friedrich Heinrich Jacobi (1743–1819). In an open letter to Jacobi (1799) argued that philosophy needed a *salto mortale* or leap of faith in order to not fall into the intellectual and practice vices of atheistic materialism. Let to itself, philosophical reason, and Fichte’s idealism in particular, led to *nihilism* regarding the true God and the material world. Fichte’s protestations of God’s ontological reality were not enough, since

²⁶ This book was published thanks to Kant’s support. As such, it was briefly mistaken by the public to be a fourth Kantian Critique. This confusion granted Fichte a considerable philosophical fame.

his secularized God was not that of Christian ontotheology, and thus suspicious in the sociologically Lutheran society of his times.

Schelling's Objective Idealism

Hegel's towering figure has eclipsed Schelling's key role in the "objective side" of German idealism. Ignored for many decades, the few philosophers who mentioned him downplayed his significance. Take, for instance, the few words that Russell devoted to Schelling in his bulky *A History of Western Philosophy*:

[Fichte's] immediate successor Schelling (1775–1854) was more amiable, but not less subjective. He was closely associated with the German romantics; philosophically, though famous in his day, he is not important. The important development from Kant's philosophy was that of Hegel.²⁷

Schelling's metaphysics is largely seen as a mere precedent and introduction to Hegel's more complete system. And his philosophy of nature dismissed as prematurely outdated. True, the development of experimental natural science in the nineteenth century had a destructive impact on the credibility of many of Schelling's scientific speculations about the nature of magnetism, gravity, or electricity. But, it is our contention that this does not totally invalidate Schelling's metaphysics, which deserves to be considered as an important episode of the history of philosophy in general, and of philosophical materialism specifically.

The challenge to the analyst of Schelling's philosophy lies in the complexity (often obscurity) of his theories as well as in its development through time in several distinct stages. But there is a logic to this development. First, Schelling moved away from Fichte's subjective idealism towards a subject-independent conception of nature. Schelling rejected Fichte's idea that matter, once eliminated Kant's *noumenon*, is just a non-Ego put by the pure Ego (Bruno 2020).

If the pure Ego is identified with absolute reality, how is it possible to imagine something outside and defined in purely negative terms with respects to the Ego? On the other hand, how can a purely objective nature give rise to subjectivity and therefore to the realm of spirit? If matter and spirit are absolutely antagonistic realities, how can they relate to each other to allow knowledge and experience? To answer those questions, Schelling drew on Spinoza. Between 1785 and 1789, the so-called pantheism controversy (*Pantheismusstreit*) confronted the anti-Spinozian Jacobi with Spinoza's defender Moses Mendelssohn. The controversy helped spreading pantheism among many German thinkers. One of them, Gotthold Ephraim Lessing (1729–1781) played a key role in the revival of Spinoza's philosophy (Josephson-Storm 2017; Goetschel 2004). And thus entered Spinoza's metaphysics into the idealism of Schelling and Hegel, and with it, although more indirectly, the Stoics materialist theology.

Schelling's holistic reading of Spinoza's metaphysics (which had been repudiated by Fichte as "dogmatism"), identified God with the whole, which he called

²⁷ Russell (1972[1945]), p. 718.

“the Absolute”. In the *Naturphilosophie* and the *Identitätsphilosophie*, Schelling attempted to overcome Kant’s and Fichte’s dualism through a metaphysical identification of matter with spirit: both the subjective and the objective are moments that fade away in the Absolute’s metaphysical indifference and identity. Matter (objective, necessary) seems to oppose spirit (subjective, free); but in the metaphysical abyss of the Absolute, they are identical. From this perspective, knowledge appears as a form of reflexivity.

Schelling’s “God” is the Absolute’s development through time. In a similar way as Fichte’s Ego and, later, Hegel’s Spirit, Schelling’s God develops historically through the evolution of human subjectivity. But, unlike Fichte, the development of Schelling’s God stems from unconscious nature. The Absolute progressively knows itself through the biological and later historical development of humans. From matter to light, organisms, and human individuals, nature develops in a progressive way towards self-awareness. The idea of unconsciousness, key to Schelling’s system, was later developed by Schopenhauer and Karl Robert Eduard von Hartmann (1842–1906).

That Schelling’s God *emerges* from matter does not make matter ontologically superior to the spirit. For Schelling, necessity/impersonal matter is temporarily previous to freedom/spirit (Bruno 2020). But, (onto)logically, freedom/spirit is previous to necessity/matter. This metaphysical paradox had a strong presence in Hegel, as we show below. To be more precise, in Schelling’s metaphysics, the spiritual side of nature exists since ever, but it does so in an *asleep* or *unconscious* form. As such, consciousness emerges from nature because it is always virtually included in it. For our purposes, this means that matter, though existing without individual actual egos (unlike in Berkeley and Fichte) is a form of spirit. For Schelling, one of nature’s key features is *productivity*. This, of course, is a very important ontological departure from the traditional views of matter as negativity and passivity. This productivity is mainly reflected on God’s progressive awakening through universal physical, chemical, biological, and human historical development.

Schelling anti-materialism also shows in his views (of Parmenidean flavor) of finite entities as appearances, as well as the identity between the object and the subject. In *Philosophy and Religion* (1804), Schelling explicitly stated that only the Absolute is truly real (Schelling 2009[1804]). As such, the multiple finite entities that surround us can only be understood in terms of the incomprehensible Absolute’s “fallenness” into finite things. Such metaphysical fallenness looks like Schelling’s secularized appropriation of traditional Christian creationism.

Multiplicity and individuality hold little ontological weight in Schelling’s philosophy. The spirit is non-individual. Schelling considered Descartes’ individual *cogito* to be a philosophical mistake. The individuality of thinking fades away in the Absolute: it is God/the totality/the Absolute what things and knows itself through us. But human conscious thinking is unable to fully grasp the Absolute’s featureless reality, in which the dualism between the objective and the subjective totally fades away. Thus, philosophy cannot positively represent the Absolute. For that reason, the Absolute’s self awareness is better grasped by some forms of art that blur the

difference between the objective and the subjective, between necessity and freedom, exteriority and interiority.

By postulating that individual egos emerge from an impersonal matter, Schelling was closer to materialism than previous Christian spiritualists and Fichte. Nevertheless, Schelling's main metaphysical mistake was to contend that the spirit (i.e., the psyche) was, somehow, already present in impersonal matter, even if in an asleep or unconscious way. This position could be considered as a form of "positive emergence" (Bueno 1993) according to which what emerges is not really new but contained in the existing reality. Although in an obscure way, nature was always "pregnant" of consciousness and spirit. This neophobic metaphysics also permeates Hegel's system.

Schelling's God is constantly revealing Himself. In this process of Revelation, mythologies are a progress towards God's self-awareness. God mainly becomes aware of Himself through humans speculating historically on the nature and essence of the divine (Schelling 2012[1842]). Like the history of politics, philosophy, and art, the history of mythologies is not for Schelling a homogeneous and straight progress. Sometimes, there are temporary recoils on the road to universal progress.

Since for Schelling God is not a personal transcendent creator, and the essence of spirit is freedom, Schelling arrived to the conclusion that the world does not have a causal explanation for its own existence. Otherwise, we would fall into the realm of causality/necessity denied by the spirit's freedom. This metaphysical position was particularly explicit in Schelling's philosophical stage of *Positivphilosophie*.²⁸ Schelling also called "metaphysical Empiricism" to this positive philosophy. He opposed it to the "negative philosophy" which studies the *essence* of something without paying attention to the radical and shocking actuality of its very existence, that is, without paying attention to *reality's primordial facticity* (see Pérez-Jara's chapter in this volume). According to Schelling, Hegel's metaphysics represents a form of negative philosophy. For Schelling, the human awareness of the groundless and unconditional character of the Absolute exposes our radical finitude and mortality. The "exuberance of being" provokes a deep feeling of awe or respect in us. Despite being usually downplayed, when not totally ignored by many manuals of history of philosophy, it is easy to see the influence of many of Schelling's ideas in the so-called existentialist philosophy, from Søren Kierkegaard to Martin Heidegger.

To sum up: Schelling's development of the idea of unconsciousness, his critiques of the dualist idea of knowledge as a form of simple representation, the thesis of matter as a condition of possibility for the emergence and evolution of individual egos, along with the denial, for contradictory, of several of the traditional characteristics of the Christian God, make Schelling's philosophy to be something worthy of consideration for the history of philosophical materialism.

²⁸ Important to note is that Schelling's lectures on positive philosophy were attended by personalities such as Engels, Bakunin, Kierkegaard, and Humboldt.

Hegel's Absolute Idealism

From Schopenhauer, Popper, to a vast majority of analytic philosophers, Hegel has attracted the wrath of many thinkers. Someone like Russell at least granted that he was worth of a deep philosophical analysis (unlike Fichte and Schelling). Russell (1972[1945]) even conceded that “Hegel saved himself by means of the influence of Spinoza”. Again, we believe Hegel did more than that. Hegel proposed his metaphysics as a synthesis between Fichte’s subjective idealism and Schelling’s objective idealism. From the first he accepted some key notions: (1) the importance of inter-subjectivity: there is no “I” without “you”; as such, the ontological figure of the ego structurally implies a plurality of egos; (2) Kant’s thing in itself is contradictory: it is postulated as totally different from the a priori categories put by the transcendental ego, at the same time that is thought through some of these categories (such as substance and causality); (3) egos develop ontologically through overcoming obstacles; Fichte’s obstacles put by the pure Ego’s will become Hegel’s processes of overcoming dialectical contradictions. From Schelling, Hegel adopted the following ideas: (1) things in themselves and human representations cannot be absolutely different, as Kant postulated: human knowledge has to be a side of absolute reality; (2) God cannot be the creationist personal unchangeable divinity of medieval Christian metaphysics; rather, also following Spinoza, God has to be everything that exists; there cannot be anything outside the Absolute; (3) unlike Spinoza, but like Schelling, God is not a given reality: it develops through time. Hegel followed Schelling’s metaphysical thesis according to which the physical, chemical, and organic stages of the universal evolution through which God starts to know Himself are unconscious. Consciousness and self-consciousness are, therefore, evolutionary products; (4) Schelling’s influence also led Hegel to consider matter as a condition of possibility for the evolution of consciousness. In Hegel’s system, matter is reality “in itself”, in contrast to consciousness, that, temporarily evolving from matter, would be reality “for itself”. Hegel, obsessed with dialectical triads, considered both moments as thesis and antithesis, synthesizing them in reality “in and for itself”, which he called the “absolute idea”.

Hegel, following Schelling, considered matter as “alienated spirit”: if spirit is interiority, matter is exteriority, if spirit is simplicity, matter is plurality, if spirit is freedom, matter is necessity. Hegel considered matter to be a degraded form of spirit, closer to the *non-ens* of Platonic and Neoplatonic metaphysics (1972[1945]). Nevertheless, Hegel also held in his *Encyclopedia of the Philosophical Sciences* that, since matter is a form of spirit, we can admire in it “God’s wisdom”. Nature should be considered as a “living whole” (2015[1817], §251). Nevertheless, Hegel emphasized at the same time that the most humble or contingent state of human psyche is a better element to understand God (2015[1817], §248).

Like Schelling, for Hegel matter/nature is chronologically previous to consciousness and egos (represented by the spirit), but (onto)logically, the spirit is previous to matter. Starting from the Kantian dualism between nature and freedom, but overcoming it, Hegel postulated, in a similar way as Schelling, that matter is an alienated or unconscious form of spirit that progressively starts to be more aware of

its own existence and possibilities: Hegel's God is the Absolute thinking about itself through human historical, cultural, and political developments.

Since matter is a form of spirit, Hegel's metaphysics is, together with Fichte, a form of exclusive spiritualism. But, like the rest of the idealists, Hegel's holistic metaphysics has no place for supernaturalism: it denies the immortality of the individual soul, miracles, prophecies, and demonic possessions. As such, for Hegel, there are no human psychologies without bodies, even if bodies are considered as a devalued form of (unconscious) spirit. And, although matter is a form of degraded spirit, its spiritual nature means that "everything real is rational and everything rational is real." (Hegel 1991[1820]). An unknowable reality totally beyond the spiritual categories of reason (like radical theology's *Deus Absconditus*, Kant's thing in itself, or even Schelling's Absolute) is just a fiction for Hegel's immanentist metaphysics; an immanentism that moved away, therefore, from Spinoza's transcendentalism, according to which the *res cogitans* would only be one among God/nature's infinite attributes. On the other hand, Hegel (1977[1807]) also moved away from Schelling's "Absolute" for being "the night in which all cows are black.". That is, for being a featureless (and therefore empty) identity.

Although according to Russell (1972[1945]), for Hegel "ultimate reality is timeless", the truth is that Hegel's "logic" does not analyze immutable Platonic entities outside the world, or God's mind "before the Creation". On the contrary, it studies the common ontological structures present in the philosophy of nature and the philosophy of spirit. Hegel (2015a[1817], §258) contended that time is an abstraction of *becoming* (in a similar way as space is an abstraction of exteriority). The Absolute, rather than "temporal", should be considered *eternal* (Hegel 2015a[1817], §258). But becoming is not a Parmenidean fiction: for Hegel, like for Fichte, being means becoming. And what becomes is the Absolute, this time thought as the totality of things. Hegel's holistic metaphysics made him to famously defend in his *Phenomenology of Spirit* that "the true is the whole". As such, nothing partial is ever completely true (Hegel 1977[1807]).

Although Hegel's holistic metaphysics often downplays the role of individuals in the ontological processes through which God knows Himself, it does not deny the importance of ontological individuality. Rather, Hegel's *Science of Logic* criticized ontological continuism: quantity–quality ontological leaps, along with ontological phenomena such as death, show that there are structural ontological discontinuities in reality. This brings Hegel closer to inclusive materialism's critiques of absolute monism (see later sections in this chapter) than to the pure indifference or identity of Schelling's Absolute, which denied the *real* existence of finite entities (Hegel 2015b[1816]).

As we have emphasized, both for Schelling and Hegel, there is nothing outside the Absolute. Therefore, the Absolute cannot think about anything but itself. In a way, this reflexivity recalls to Aristotle's God (*νοήσεως νόησις*, "thought of thought"). But, unlike Aristotle's God, Hegel's God is everything that exists, which is in constant evolution. Behind Hegel's often obscure dialectics, we can find a metaphysics that, in opposition to medieval ontotheology, emphasized the dynamic character of reality, the crucial importance of intersubjectivity, the nonexistence

of supernatural phenomena, and other important valuable ideas for philosophical materialism.

Schopenhauer's Materialist Idealism

Arthur Schopenhauer (1788–1860) is the most important idealist philosopher to have despised idealist philosophy, at least that of his rivals Fichte, Schelling, and Hegel. He would rather pair himself with Kant. And yet, many of his ideas can be traced back to his opponents, including Schelling's unconsciousness and the theory of the objectification of God in nature. But Schopenhauer did not recognize those debts and explained his project as the redefinition of Kant's transcendental consciousness, his a priori categories and forms, along with the "thing in itself". Schopenhauer also explicitly drew on Eastern philosophies, mainly on Hinduism and Buddhism, which played an important role not only in his ethics and anthropology, but also in his metaphysics.

Against the spiritualism defended by Descartes, Kant or Fichte, Schopenhauer grounded the true roots of the transcendental consciousness on the *human brain*, rather than on a disembodied spiritual activity. In yet another twist to Kant's philosophy consisted, he reduced the twelve a priori categories of the understanding to only one, the principle of sufficient reason as it had been formulated by Christian Wolff (1679–1754). Against the Parmenidean, Platonic, and Aristotelian spiritualist duality between sensibility and understanding, Schopenhauer (2018[1859]) fused both: a pure sensibility is impossible, every sensible intuition implies the principle of sufficient reason. For that reason, Schopenhauer defended that animals, although intellectually inferior to human beings, are not only capable of suffering and willing: they also manage a basic version of the principle of sufficient reason, without which they would die. Against the radical spiritualist thesis held by thinkers such as Gómez Pereira (1500–1567), Descartes (1596–1650), and Malebranche (1638–1715) according to which animals are machines without emotions and thinking (Pereira 2019[1554]), Schopenhauer defended that the animal and human psyche is a system of biological devices prepared for the survival in hostile and complex environments.

Despite these unquestionable materialist elements in Schopenhauer's metaphysics, he embraced idealist positions. His rejection of naive realism led him to declare, following Kant's Transcendental Aesthetics, the ideal nature of physical matter. This means that Schopenhauer's metaphysics conserves Kant's division of reality into two realms: Kant's phenomena became, in Schopenhauer's metaphysics, the world as representation (*Vorstellung*), whereas the thing in itself/*noumenon* became the Will (*Wille*). Despite being the mother of countless misunderstandings, Schopenhauer's "Will" is the most important concept in his metaphysics. Schopenhauer identified absolute reality with an impersonal force that manifests or objectifies itself in everything that exists, from the most basic physical and chemical processes, to the most advanced biological and sociocultural processes present in human beings. Thus, behind physical phenomena such as gravitation or magnetism, a basic manifestation of the Will underlies. The Will is the active principle of the

World. Schopenhauer's Will achieves its highest degree of expression in humans' desires and dissatisfaction.

Following Kant, Schopenhauer postulated that neither space, time, nor causality are characteristics of the absolute reality. Logically, this implies that Schopenhauer's Will (i.e., the absolute force that constitutes reality) is, like the Christian ontotheological God, immutable, simple, and without any cause or reason for its own existence. But, unlike the traditional Christian God, the Will is a purely non-creator impersonal entity. If Schelling held that the Absolute is an *Abgrund* (abyss), Schopenhauer contended that the Will is *Grundloss* (without reason). Both ideas will greatly influence Heidegger's ontology.

If for Kant the experience of human freedom connected us to the thing in itself, for Schopenhauer, the identification between our bodily movements and our acts of will opens the way to the identification between the Kantian thing-in-itself and the World as Will. The identity between our will and our bodily movements makes us to realize, according to Schopenhauer, that we, beyond phenomena, are internally composed of Will. We are then in a position to extend this discovery, although in different degrees, to every corner of the material world, which in this light appears as an objectification of the Will (2014[1859]; 2018[1859]).

Infinite Will is beyond any possible understanding, since there is no cognition without space, time, and causality. This does not mean that Schopenhauer considers metaphysical knowledge impossible; Schopenhauer criticizes Kant's very narrow limits for metaphysics. According to Schopenhauer, Kant's antinomies in the *Critique of Pure Reason* are totally factious: we can philosophically demonstrate that the World is not a transcendental illusion, but an eternal and spatially infinite reality non-created by any providential God (Schopenhauer 2017[1851]). We cannot, Schopenhauer claimed, conceive the non-eternity of matter. Schopenhauer (2016[1851]) even poetically identified the World with Vishnu, the supreme divinity of many forms of Hinduism.

Against Schopenhauer's materialist side, there are important thinkers, such as Russell (1972[1945]), who have emphasized that Schopenhauer "believed in spiritualism and magic." Despite it is true that in *Parerga and Paralipomena* (1851) Schopenhauer contended the truth of many phenomena traditionally linked to spiritualism and magic, he gave them a completely non-spiritualist explanation: unlike Kant, Schopenhauer (2016[1851]; 2017[1851]) held that the Will's "omnipotence" can break the spatio-temporal causality of the World as representation. After several misunderstandings provoked by the first edition of his magnum opus *The World as Will and Representation* (1819, 1859),²⁹ Schopenhauer's *Parerga and Paralipomena* and other writing emphasized that the Will was not a literal psychic force. To talk about "Will" was just a metaphor that pointed out at a completely impersonal force.

²⁹ *The World as Will and Representation*'s first edition was published in late 1818, with the date 1819 on the title-page. In 1844, a second edition appeared. This edition was divided into two volumes: the first one was an edited version of the 1818 edition, while the second volume was a collection of commentaries about the ideas expounded in the first volume. In 1859, at the end of Schopenhauer's life, a third expanded edition was published.

The psyche is a collection of means, generated by the brain, to achieve the Will's blind "goals": reproduction, nutrition, rest and so on as manifestation of the will to persevere in existence (Schopenhauer 2014[1859]). He named it "will" because of the analogies between this blind force and animal and human volition. Without recognizing Schelling's influence, Schopenhauer argued that the unconscious drive of the Will structured reality, from physical and chemical processes to more advanced realities such as human sexuality.³⁰

Schopenhauer explicitly placed the aprioristic Kantian categories of the intellect (now reduced only to causality) in the human and animal brain.³¹ For that reason, Gustavo Bueno, inspired by Paul Janet, talked about Schopenhauer's "idealist materialism" (1972: 166; 2019). This oxymoron is dissolved once we pay attention to the main inconsistency of Schopenhauer's philosophy, namely the attempt of explaining the a priori forms of cognition of space, time, and causality in terms of brain processes (Schopenhauer 2014[1859], 2018[1859]). But the brain is already a spatial, temporal, and causal reality! How can we explain the ideal character of matter through the brain if it is already material? The only possible way to break this vicious circle in which Schopenhauer fell into is to abandon Kant's transcendental idealism without neither returning to naive realism nor following the radical spiritualism defended by German idealism. This is precisely the way followed by the inclusive materialism that we defend in this chapter. We know that we cannot hypostatize the organoleptic morphologies of the world we perceive because they greatly depend on our organs, nervous systems, and sociocultural environment.³² The organoleptic world emerges from the ontological encounter between a independent material reality and highly evolved biological processes (processes socioculturally and historically shaped in the case of humans). Neither that independent material reality is Kant's thing in it self, nor the biological, historical and sociocultural processes that shape human perception and understanding of the world is Kant's Transcendental Ego.

Finally, the abandonment of Kant's Transcendental Aesthetic and Transcendental Analytic also implies to overcome Schopenhauer's most anti-materialist idea, namely the immutable and absolutely simple character of absolute reality.

The Materialist Controversy in Germany

By the 1840s idealism was in decline in Germany. This was in part a consequence of the tremendous success of the sciences. Observation, experiment, and mathematics

³⁰ Schopenhauer's metaphysics of sexuality brilliantly anticipates many hypotheses of evolutionary biology: see Pérez-Jara (2011).

³¹ Schopenhauer agreed with Schulze's critique of Kant's contradictory use of causality. For Schopenhauer, the thing in it self (i.e., the Will) is not the cause of our sensations. Rather, our sensations are a (non-causal) manifestation of the Will.

³² Here, we use the concept of organoleptic in its usual meaning of relative to our sensory experiences, so the "organoleptic world" is the set of phenomena, from the taste of wine to the colors of the sky, filtered through our sense organs.

replaced dialectics as a paradigm of rationality. Not only physics and chemistry were achieving major triumphs but also the scientific methods were applied (or attempted to be) to biology, psychology, and historical analysis.

On significant occasions, these developments went hand in hand with a critique of religion. David Strauss and Bruno Bauer championed the critique of positive religion in two famous books of biblical studies. They showed that some religious beliefs rationalized by the Hegelian dialectics were no more than mythical impostures or poetical expressions of human wishes (Bauer 1841; Strauss 1835). By the same epoch, Helmholtz's enunciation of the principle of the conservation of energy made suspicious the very idea of a divine creation. The rising authority of modern science contributed to spread the idea that only matter exists. Many physicists used and transformed concepts and techniques from idealism while attacking its central tenets (Wise 2018), and others coordinated new knowledge, for instance of thermodynamics, with the old prophecies of evangelical religions (Smith and Wise 1989). But the scientific bang gave new wings to new varieties of materialism.

A new breed of materialists, different from those of the *le siècle des Lumières*, were ready to champion the old cause and engaged in numerous disputes that went from the mid 1850s till the end of the century. The main ones were Carl Vogt (1817–95), the author of the polemic *Köhlerglaube und Wissenschaft: Eine Streitschrift gegen Hofrath Wagner in Göttingen* (Vogt 1855) and Ludwig Büchner, whose *Kraft und Stoff* was considered as “the Bible of materialism”. This latter book was also published in 1855 and went through twenty-one editions and it was translated into seventeen languages (Büchner 1855). The key for such a success lays probably in the fact that the book was written without technicalities and straight to the point. Büchner aimed at the general public. He presented a wholly naturalistic worldview with no room for the Divine, miracles, or any form of transcendence. He insisted, however, that his concept of matter should not be confused with the Cartesian idea of matter as inert stuff. For Büchner, matter, endowed with force (i.e. the capability of interacting), was a center of activity. In his book he offered many examples from magnetism to chemical reactions. Matter, he argued, is self-sufficient, an eternal substance in permanent change. His doctrine, we might say, was closer to the Milesians or even Heraclitus than to Democritus or Lucretius.

Such ideas did not go unquestioned. Not only theologians but atheistic metaphysicians confronted them. Pessimist philosophers such as Julius Frauenstädt (1813–79) agreed with the materialist position, but only insofar it is applied only to the phenomenal or natural world and not beyond it. A disciple of Schopenhauer, Frauenstädt separated appearances and things-in-themselves. The realm of moral and purposefulness was the second, not the first one (Frauenstädt 1856). He accused Büchner and his fellow materialists of naive realism.

Also based on Kant's ideas was the critique presented by Friedrich Lange (1828–75) in his famous *The History of Materialism*, one of the most influential books of the second half of the nineteenth century (Lange 1866). Lange argued that the noumenal world is not an ontological realm filled with supernatural objects but a strictly normative realm containing moral and aesthetic values. These values are not things-in-themselves but our creations, which have nonetheless universal and

necessary validity. Lange's book was the first comprehensive history of materialism, and beyond its neo-Kantian criticism it had enduring value as such.

It is not possible to make justice here to the rich controversy around German materialism in the period 1850–1900. The publication of Darwin's *On the Origin of Species by Means of Natural Selection, or the Preservation of Favoured Races in the Struggle for Life* in 1859 added a new dimension to the already hot debate around materialism and the naturalist worldview. The interested reader is referred to the excellent books by Gregory (1977) and Beiser (2014) for further details and references.

From German Idealism to Marx's and Engels' Materialism

Karl Marx's and Friedrich Engels' "dialectical materialism" had an enormous practical and theoretical weight throughout twentieth century. There are thinkers who go as far as contending that, in a sense, every relevant philosopher of the last 150 years is under the shadow of Hegelian and materialist dialectics (Zizek 2013). Here, instead of either glorifying or downplaying dialectical materialism's philosophical importance, we will summarize the main strongest and weakest points of such worldview, underlying its deep connections to German idealism and its understanding of matter.

Although the influence of seventeenth, eighteenth and nineteenth centuries mechanistic materialism was key in the development of Marx's and Engels' philosophical materialism, the impact of Modern idealism cannot be downplayed. As Ludwig Feuerbach (1804–1872) had done in his own way, Karl Marx (1818–1883) and Friedrich Engels (1820–1895) took advantage of many theses of German idealism for their particular conception of philosophical materialism. Specifically, and against attempts to abandon Hegel, Marx declared himself his disciple. His project, he announced, was an "overturning" or materialist "reversal" (*Umstülpung*) of Hegelian ontology (Marx 2014[1844]). Among other writings, Marx did just that in his *Critique of Hegel's Philosophy of Right* (1844). Nevertheless, Marx's reversal of Hegel's worldview has often been misunderstood as if Hegel held that a personal and a conscious spirit was previous to the existence of matter. As we have seen, behind Hegel's Christian rhetoric, a deeply secularized metaphysics stood. Therefore, we need to interpret Marx's (and later Engels') *Umstülpung* in more rigorous terms (Bueno 2008).

Marx wrote little about metaphysical topics. As such, he relied on his philosophical companion, Engels, to found the ontological premises of his political, economic, and sociocultural philosophy. But there are significant ontological insights in Marx's philosophy. Marx's metaphysical background ranges from Greek atomism and Aristotle to the German idealists. His most relevant contribution to metaphysics might be his idea of production. Key metaphysical components of Fichte's ego (as dominating nature) and Hegel's spirit (as a creative force) survive in this concept, as Marx partly recognized when speaking of the "active side of German idealism" in his *Theses on Feuerbach* (1888): see Marx and Engels 1976[1888], and James 1980[1948]. In Marx, only through production does reality become meaningful for humans.

The idealist binary opposition between nature and spirit also survived in Marx's distinctions between nature and culture and between consciousness/subject and world/object. Marx adapted Hegel's "objective spirit" and "process of objectification" for his own worldview. Similarly, he also adopted Hegel's emphasis on "dialectical processes" pervading history and societies' structures and interactions. Marx also drew on Fichte's insistence on the intersubjective nature of the ego. Marx even appropriated Schelling's unconscious: Marxist class consciousness implies a more common situation of class unconsciousness of the processes constituting asymmetrical human societies and interactions.

Engels' ontology was more ambitious. His unfinished *Dialectics of Nature* (1883) was a significant contribution to metaphysics. Working on that book for a decade, Engels proposed a dialectical materialism supported on both a naive positivism regarding natural sciences and dialectical metaphysical laws. In a similar way as in Marx's sociocultural and historical ontology, Engels' metaphysics revolved around the Hegelian notion of contradiction and conflict as applied to the whole of reality, both physical and human. Engels' three laws of dialectics are the law of the unity and conflict of opposites; the law of the passage of quantitative changes into qualitative changes; and the law of the negation of the negation. The Hegelian influence of each of these laws is undeniable (McClendon 2004).

Take what is today perhaps the most influential of these principles, "the law of the transformation of quantity into quality and vice versa". Hegel's *Science of Logic* (1812, 1816) discussed such qualitative jumps. And, already for Hegel, they imply important ontological discontinuities and ruptures in reality, thus contradicting the extended approach to Hegel and Engels as absolute continuist philosophers. But Engels' "qualitative jumps" are a rather obscure and contradictory form of presenting emergence (Bunge 2003, 2010). By trying to understand ontic oppositions and strife through Hegelian dialectics, Engels ended up developing a rather obscure metaphysics, whose main inconsistencies arise from applying Hegelian dialectics to physical and chemical processes and from the (attempted) development of a "dialectical logic" (Bueno 1972; Bunge 2010).

For Engels, matter is a general abstraction that behaves "like the idea of fruit in respect to cherries, pears and apples." (Engels 2012[1883]). As such, what is real is not matter, but concrete material entities.³³ As we saw, Hegel, on his part, had declared matter to be a form of spirit. But recall that, chronologically, Hegel starts with stars, rocks, mountains, and rivers. From mechanic interactions to organic beings, reality evolves towards self-awareness. But Hegel thought impossible for psychological life to exist as a completely new product relative to physical, chemical, and organic matter. If such emergence is impossible, Hegel thought following Schelling, then psychic life has always to be virtually included in matter (like, we could say, a tree is virtually included in a seed). And, because before the emergence of animals (and above all, human beings) matter does neither think nor

³³ For a very interesting philosophical analysis on this topic, see: Bueno (1972), pp. 50, 52, 60, 72, 283, 288.

feel, it is clear that the “spirit” (i.e., psychological life) is included in matter from the onset in an “alienated way”. For Hegel, the emergence of consciousness, therefore, is a necessary product of matter. Engels followed this Hegelian thesis. Matter, in its eternal cycle, necessarily produces the thinking spirit. Thus, if the thinking spirit disappears, it will appear again in another part of the universe (Engels 2012[1883]). Naturally, Engels’ thesis implies a metaphysical anthropocentrism incompatible with a true materialist understanding of the many contingent physical, chemical, and biological processes that take “intelligent thinking” into account.

In this section we have seek to demonstrate that, paradoxically enough, German idealism displays key (if often downplayed) materialist components and that Marx’s and Engels’ dialectical materialism mobilizes relevant, if also often overlooked, idealist components. Dialectical materialism resulted from the transformation of seventeenth and eighteenth centuries materialist ontologies through German idealism, just as German idealism was a secularized development of Christian metaphysics.

1.7 The Scientific Bang

Independently from the new idealist and materialist philosophies, but not completely detached from them, nineteenth century sciences took notions of matter in different fields to completely new realms. Contemporarily with the Baron d’Holbach, the French chemist Antoine-Laurent de Lavoisier (1743–1794) reorganized chemical matter through a new nomenclature that clearly defined the field of modern chemistry. Thanks to this new system of terms and through precise experiments with balances, he concluded that the quantity of matter (mass) always remains the same through chemical reactions. This clear separation between matter and mass, which came to be understood as a property of the former, is of paramount importance in the history of materialism. John Dalton (1766–1844) moved Lavoisier’s chemical revolution forward reintroducing the atomic theory. The main points of his theory as presented in *A New System of Chemical Philosophy* (1808–1827) were of lasting significance for materialistic understandings of matter:

- Chemical elements are made of extremely small particles called atoms.
- Atoms of a given element are identical in size, mass and other properties; atoms of different elements differ in size, mass and other properties.
- Atoms cannot be subdivided, created or destroyed (something that was proved to be wrong in the twentieth century).
- Atoms of different elements combine in simple whole-number ratios to form chemical compounds. This allowed Dalton to make sound predictions.
- In chemical reactions, atoms are combined, separated or rearranged.

The nineteenth century also saw the birth of thermodynamics and its advance at fast pace. Drawing on the work of Joseph Black and James Watt, Sadi Carnot, published his *Reflections on the Motive Power of Fire* (1824), a treatise on heat,

power, energy, and engine efficiency. The book outlined the basic energetic relations among the Carnot engine, the Carnot cycle, and motive power, marking the starting point of thermodynamics and contributing to a technological revolution which reshaped the world. The first and second laws of thermodynamics emerged simultaneously in the 1850s, primarily out of the works of William Rankine, Rudolf Clausius, and William Thomson (Lord Kelvin). All these efforts configured an image of the world that was essentially mechanistic, and certainly materialistic (see Purrington 1997 for a full account; see also Camprubi's chapter in this volume). Partly modeled in Lavoisier's law of the conservation of mass, the generalized law of the conservation of energy was formulated in the mid-nineteenth century simultaneously in Great Britain and in Germany. Hermann von Helmholtz's 1847 *Über die Erhaltung der Kraft* (On the Conservation of Force) established the principle and in 1850 William Rankine referred to it as "the law of the conservation of energy". Energy came to be considered a universal property possessed by any kind of matter in the physical world.

Another milestone of nineteenth century physics was the development of the kinetic theory of gases by Maxwell, Gibbs, and Boltzmann (Purrington 1997; Van Melsen 2004; Yourgrau et al. 1982). By first time a macroscopic theory (thermodynamics) was recovered as a limit of a microscopic theory (the atomic theory). Properties such as temperature, pressure, entropy, heat, equilibrium, and empirical numbers appearing in classical thermodynamics could now be understood as an effect of the properties of tiny particles and their own properties. Boltzmann was the champion of the battle between atomists and energeticists (including Ernst Mach and Wilhelm Ostwald, who viewed energy as a kind of fluid and even proclaimed the death of matter). The controversy was settled by Einstein, who explained Brownian motion as an effect of atomic motions in 1905 and by Jean Perrine, who experimentally demonstrated the existence of atoms in 1908. Energy was firmly established as a property of physical systems and not an entity in itself. Atoms exist, thus posthumously vindicating Boltzmann who had committed suicide just two years before Perrine's results (Broda 1983).

A fourth radical advance in the physical sciences was the electromagnetic theory and its long development along the nineteenth century. Already in the late seventeenth century various electricians postulated that electricity might be considered a kind of region of space with the potential to affect the motion of charged bodies (Cao 1997). These ideas were an *ad hoc* device to describe the motion of charges and magnets rather than the identification of a new kind of entity of independent existence. Such a bold step was taken in 1844 by Michael Faraday (1791–1867). Extending ideas of Boscovich, Faraday postulated the existence of continuous lines of forces, through which the electromagnetic actions were transmitted. These lines were real in the sense that they were affected by matter and could affect matter in return and in that energy can be present in them outside of any other body. This was the concept of *field* (Cao 1997; Hesse 2005, Romero in this book).

The physical reality of electromagnetic fields was not initially recognized because it was not obvious how such an entity could be accommodated in the dominant mechanist worldview of the time. Thompson developed a complex model

of a mechanical ether and James Clerk Maxwell developed his electromagnetic equations not as field equations but as equations describing how electromagnetic actions are propagated through Thompson's mechanical ether. It was only much later, with Hertz's demonstration that electromagnetic waves can propagate through empty space, that the concept of field finally imposed itself. Maxwell's theory was reinterpreted as a field theory by Lorentz and others. It produced a deep impression upon the young Einstein, who thought the field theory far superior to the purely mechanical interpretations. This led first to Special Relativity, with its reformulation of classical mechanics, and later to General Relativity where spacetime itself is endowed with energy and considered as a material stuff.

The actual meanders of nineteenth century physics and the complexities introduced by field theories and General Relativity in the twentieth and twenty-first centuries exceed the goals of this chapter. So do the no less important developments in biology, where Charles Darwin and others established the theory of evolution by natural selection, yielding a materialistic revolution of their own. Organisms emerged as highly organized forms of matter, not alien to universal laws comparable to those affecting all other systems in the universe. While this nineteenth century scientific bang opened up all kinds of philosophical interpretations and disputes, it also set the scenario for the varieties of the heterogeneous materialist theories that exploded in the next century.

1.8 Varieties of Materialism

We have already insisted on the variety of existent branches within the big family of philosophical materialism. This is most true for twentieth century philosophy. It is, however, useful to classify (and therefore simplify) this plurality to locate relevant differences and similarities. There are several possible criteria. For instance, some materialisms are implicit and other explicit. Implicit materialists were the philosophers who developed their worldviews before the emergence of the word materialism in the seventeenth century. But also the philosophers who held materialist stances but disliked the term. For instance, Heidegger never presented his obscure metaphysics as a materialist philosophy. And yet, he explicitly defended that absolute reality is meaningless and valueless without the phenomenological activity of human beings, who are structurally corporeal, finite, and mortal (Sheehan 2014). Even more, he explicitly rejected the spiritualist God of Christianity. Therefore, we could talk about Heidegger's "existentialist materialism" as we talk about Spinoza's or Schopenhauer's forms of materialism.

The criteria we use here, inspired by Bunge (2010), go more directly to the ontological contents, dividing materialisms into two main families: exclusive materialisms and inclusive materialisms. The first *exclude* the ontological reality of the psyche as well as of concepts or ideas, whereas inclusive materialisms include both of these kinds of realities (although always emphasizing that such realities cannot exist without physical, chemical, and biological entities and processes: see

Bueno 1972; Bunge 1977; Pérez-Jara 2014; Romero 2018). With this in mind, let us briefly overview twentieth century varieties of philosophical materialism.

Marxist Materialism

Marx's and Engels' dialectical materialism became, with significant updates, the official ontological view of the Soviet Union and several communist countries during the twentieth century. In the Soviet Union, dialectical materialism (*Diamat*) was seen as complementary to historical materialism (*Histomat*). We would not want to underestimate *Diamat*'s obvious philosophical virtues. As Engels had already argued in his *Dialectic of Nature* against animism, pure spirits are impossible because they violate the laws of conservation of energy. Against ontotheology, it affirmed the eternity of matter and the nonexistence of the ontotheological God. Against anti-philosophy and relativism, *Diamat* offered a philosophical system trying to coordinate ontology, epistemology, philosophical anthropology, philosophy of history, political philosophy, ethics, and so on. Finally, it went beyond classical mechanistic materialism through its dynamic view of reality, supported on Hegel's process metaphysics.

That said, *Diamat*'s philosophical difficulties were also notorious. Lenin's definition of matter as what is independent from human consciousness was directly inspired by Fichte's division between idealism/criticism and dogmatism/materialism. It thus carried the excesses of Fichte's definition, which forced him to group Berkeley's philosophy with the "materialists" (Bueno 1972). No less fatal, *Diamat* rested on Engels' laws of dialectics, whose obscurity we reviewed in the latter section. It is false that every entity or process is the result of an "unity of opposites", as for instance quarks and leptons show. Furthermore, every "opposite" should also be composed of other opposites, *ad infinitum*. It is also false that every change in reality comes from the "contradiction" or "struggle" of such opposites. The number of physical, chemical, biological, sociocultural, and technological examples of processes that cannot be understood in terms of contradictions is simply too large to enumerate. Emphasizing struggles and contradictions is sound to confront static and harmonic views of reality. But the price to pay cannot be as high as Engels' or the Soviet laws of dialectics.

Was *Diamat* a form of inclusive or exclusive materialism? In general, Soviet philosophers followed Engels' Hegelian thesis that the "human spirit" is a necessary product of matter. Although they clearly emphasized that the latter could not exist without the former, the distinction between "physical matter" and the "human thinking spirit" is, in our view, enough to include most of them under the inclusive materialist category. Nevertheless, Engelian-Leninist analysis of the relationship between the human mind and physical matter were frail. Lenin's critiques of Joseph Dietzgen's thesis about the material nature of thought is a good example. Lenin contended that such inclusion of the psychological within the material ruined the epistemological difference between mind and matter and thus (suspiciously) dissolved the ontological divide between materialism and idealism (Lenin 2011[1909]).

Just as Lenin, Joseph Stalin (1878–1953) also made philosophical theory a part of his political practice. Stalin departed from Lenin’s clear cut division between mind and matter and embraced a sort of neutral monism according to which “the mental and the material are two different forms of the same phenomenon” (Rosental and Yudin 1945). Stalin’s *sui generis* neutral monism was confusing and hardly developed. Its main merit was the critique of vulgar materialism, but at the cost of not differentiating the qualitative discontinuities between physical matter, chemical matter, and biological matter’s psychological processes in complex animals equipped with nervous systems. Before its peculiar Soviet version, neutral monism was a philosophy mainly advanced by Ernst Mach, William James, and Bertrand Russell. In its different versions, neutral monism postulated that physical events and mental events are expressions or dimensions of a common neutral reality –expressions whose boundaries are conventional or logical, rather than ontological. Thus, for instance, in Russell’s version of neutral monism, both mind and matter are epistemologically inferred and logically constructed –which means that, without human beings, there are no mind and matter, but an unknown previous reality. Russell combined this view with a structural realism, according to which we can only know some general structural properties of that previous, subject-independent reality, but not the intrinsic qualitative properties of subject-independent events.

Stalin’s downfall and subsequent *damnatio memoriae* erased his views from the *Dictionary of Soviet Marxist Philosophy*. Once again, the official doctrine became Engels’ and Lenin’s dualism between matter and the psyche. The psychoneural identity theory was rejected as “vulgar materialism”.³⁴ Mario Bunge, who we classify below as an inclusive materialist, received harsh criticisms after proposing psychoneural identity in a Russian and a Hungarian journals in 1979 and 1982 respectively. As testimony of the strange alliances Soviet dualism led to, he wrote:

Interestingly, whereas my Soviet critic was presumably a Marxism expert, my critic in the Hungarian journal of Marxist philosophy was an eminent neuroscientist, Janos Szentagothai, who also happened to be a devout Christian.³⁵

The conclusion seems obvious: ontologically speaking, Soviet materialism represented a form of inclusive materialism at the price of threatening its own consistency as a materialist worldview. Diamat’s epistemology was not less flawed than its ontology. Soviet philosophers too often discarded scientific and philosophical ideas arguing only that they “contradict Engels”, or were written by “lackeys of the bourgeoisie” (Lenin 2011[1909]). This dogmatic approach led to the rejection and even demonization of scientific theories in the most diverse fields, including non-dialectical logic, relativity, quantum mechanics, genetics, and functionalist sociology. All of them, apparently, were considered as corrupt capitalist doctrines incompatible with a dialectical understanding of matter and of the revolution. But it would be inaccurate or directly ideologically fraud to claim that *Diamat* was totally

³⁴ Jarochevski (1975), p. 168.

³⁵ Bunge (2010), p. 127.

anti-science or that all research was bankrupt under Soviet leadership. Communist countries in general, and specifically the Soviet Union, devoted significant resources to scientific research, most often with practical purposes such as industrialization, weaponry, and the space race (Kojevnikov 2004). And recognized scientist such as Landau, Ginzburg, Fock, Zeldovich, and many others were allowed to work on theoretical physics, arriving, on many occasions, to impressive results.

Less dogmatic were the application and transformation of Marxist ideas to the fields of prehistory, history, sociology, and cultural anthropology outside the communist sphere. Among these we can highlight the works of Gordon Childe (2017[1951], 2009[1958]), Leslie White 2007[1959], and Marvin Harris (1979). But their ontological and epistemological significance regarding materialism was also less prominent.

Eliminative Materialism, Reductive Materialism, and Revisionary Materialism

If Marxist materialism was the official ontological view of the majority of communist countries, reductive materialism (or physicalism), along with eliminativism, became the dominant materialist counterpart in countries outside the communist sphere. When talking about physicalism, we might distinguish its ontological and epistemological variations. Otto Neurath (1983[1931]) and Rudolf Carnap (1959[1932/33]) coined “physicalism” as a philosophical concept. Despite some differences in their respective understandings of it, both philosophers gave it a purely epistemological sense: every empirical statement is equivalent with a physical statement (Hempel 1949[1980]). The Vienna Circle combined this epistemological physicalism with an implicit phenomenalist metaphysics very close to idealism and, in some cases, to solipsism.

Ontological physicalism is more interesting for the purposes of this chapter. It states that everything real is either physical or ontologically reducible to the physical. This thesis has been particularly successful in the twentieth century philosophy of mind. Within this theory, the Australian “identity theory” between mental processes and brain processes represents a very good example of both the philosophical virtues and flaws of ontological physicalism. Australian materialism (also called “Australian realism”) started as a philosophical movement in the mid-twentieth century and spread in several Australian universities despite the social stigma of materialism in the Cold War context. Philosophers such as Place (1956), Smart (1963), and Armstrong (1968) confronted the mind–body problem, instead of despising it as a pseudo-problem as most members of the Vienna Circle. These authors developed the theory of the identity of mental processes and brain processes, which they called “identity theory” and “central–state materialism”. Although this identification is millennia old, Australian materialists could for the first time support it on solid scientific neurological evidence.

The theory’s virtues with respect to animism and metaphysical spiritualism are obvious. But, as nineteenth century “vulgar materialisms”, its proponents failed to develop a sufficiently rigorous ontological and epistemological background to support their claims. They remained unaware of the pitfalls and dead ends of

reductionistic materialism. Although neurological processes cannot obviously exist without chemical reactions, or more basic biological processes, they have qualitative properties irreducible to chemistry, not to mention physics. It is simply not possible to account for psychological processes only in physical terms. It was even harder for Australian materialist to say something meaningful about political, economic, and social systems without betraying their own physicalist assumptions. But even limiting the analyses to their ontology of physical matter, Australian materialists lacked rigorous ontological doctrines on causality, spacetime,³⁶ and modal ideas. Current versions of this tradition have, in Bunge's ironic and somehow unfair terms, "dematerialized for lack of scientific nourishment" (Bunge 2010). Armstrong, one of its main founders, has developed a "states of affairs" ontology that seems no longer interested in matter (1997). Armstrong claims that "affairs" (or states) are the universe's basic ontological units, but he lacks the enough knowledge on physics to develop a consistent process metaphysics, as for example Gustavo E. Romero's more recent materialist event ontology has done (2016).³⁷

Some philosophers have sought to supersede the reductionist materialism of identity theory while keeping their distance from spiritualism. John Searle's solution is that the brain "causes" the mind. Searle's philosophy of mind (1992, 1995, 1997, 2005, 2007) seeks a middle ground between materialism (which he identifies with physicalism) and psychoneural dualism (shared by Christians, Soviet Marxists, and philosophers like Karl Popper and John Eccles). Regrettably, the price he is ready to pay is a confusing and contradictory ontological doctrine of causality. Bunge ironically objected to Searle that to "maintain that the brain causes the mind (...) is like stating that legs cause walking, rather than walking being the specific function of legs."³⁸

In the second half of the twentieth century, a more radical form of physicalism arose through the so-called "eliminative materialism". Different versions of it were offered by Randall Jr. (Randall (1958)), Rorty (1970), Churchland and Sejnowski (1993), Churchland (1984), and Dennett (1991). Randall aimed at "killing" the concept of mind, just as William James had destroyed the concept of consciousness. Another early precedent was radical behaviorism, although more methodologically than ontologically. According to eliminativism, psychological entities just do not exist; they belong to "folk psychology" and will gradually disappear from the scientific vocabulary as science moves forward, exactly as we got rid of the pseudo-scientific concept of the phlogiston. The psyche is a misdescription of brain processes. Consequently, it should not play any role in any serious scientific theory of the mind.

³⁶ Notable exceptions can be found in the work of J.C.C. Smart, Graham Nerlich, and Hugh Price who worked extensively on the ontology of spacetime and related problems.

³⁷ On the other hand, Bunge (2010) opposed both approaches, because for him there cannot be states or events without entities. Romero, however, points out that materialist ontologies based on concrete things or particular events are formally equivalent (Romero 2013, 2016): to consider things or events as basic is rather a matter of taste and not of fact.

³⁸ Bunge (2010), p. 148.

Eliminative materialists have often focused their attacks on *qualia*, denying their real existence as mere illusions. But this brings eliminativists to an obvious contradiction: without *qualia*, which imply the organoleptic scale with which we interact with the world, their own scientific and philosophical investigations would be impossible. Indeed, the eliminativists' point of departure is always a phenomenological world of colors, shapes, smells, desires, thoughts and memories. From there, they regress to the neurobiological processes behind these phenomena, only to deny the starting world as illusory or non-existent (Churchland and Sejnowski 1993; Churchland 1984; Dennett 1991). But they do not specify the ontological status of such an "illusion", a word that eliminative materialists take from the "folk psychology" that they want to get rid of. In other words, eliminativists attempt to explain *qualia* by pretending that these realities do not exist (Bueno 2016; Ongay 2019; Pérez-Jara 2014). The false dilemma of eliminative materialism (to either hypostatize psychological life or to completely deny it) is an unwillingly prisoner of the traditional Christian theological idea whereby the existence of psychological processes implies a supernatural soul or spirit. As such, eliminative materialism is an unconscious victim of theological propaganda (Pérez-Jara 2014).

Granted, eliminative materialism is a useful denounce of spiritualist dualism and brainless psychology. What is more, some of the points of Churchland (1986) and Churchland (1981) for revising "folk psychology" based on neuroscientific advances are commendable. But it is a *non sequitur* to conclude that studying the brain will rule out psychology in general. According to some eliminative materialist philosophers, future developments in the theory of connectionism and its models of the human brain will definitively prove that the processes of language learning, along with other forms of semantic representation, are highly neurologically distributed and parallel. From this, they conclude that there is no need for such discrete and semantically endowed entities as beliefs and desires (Ramsey et al. 1990). There is no reason to share their hopes, beliefs, and desires.³⁹ The goal should be instead to update psychology in the light of cognitive neuroscience, reinterpreting rather than ignoring concepts such as personality, memories, unconscious, and emotions. This project is not a chimera: it is precisely what current cognitive and affective neuroscience does.

Against the excesses of eliminative materialism, John Bickle and others have sought a middle ground through "revisionary" materialism or physicalism. According to this approach, only a partial revision of both our common sense and traditional psychology would be necessary. In Bickle's own words, "the focus of much recent debate between realists and eliminativists about the propositional attitudes obscures the fact that a spectrum of positions lies between these celebrated extremes (Bickle 1992)." Many have sought such middle positions, not all with equal success.

³⁹ It would also be interesting to wonder if these philosophers, in their daily lives (or even in their lectures and conferences) exclusively use complex neuroscientific terminology each time that they want to express that they feel tired, forgot something, feel disappointed, or are hungry.

Anti-Reductionist Materialism

Against reductionism and eliminativism, an explicit form of inclusive materialism in the twentieth century was represented by Roy Woods Sellars' "emergent realism". This philosophical approach combined systemic materialism with emergentism and scientism (Sellars 1969[1922]; 1970). Sellars' emergent realism disproved the common misunderstanding of taking "physicalism" and "materialism" as interchangeable terms. His sophisticated materialist metaphysics recognizes that neither psychological nor eidetic contents would exist without a physical substratum. But also that there is enough scientific and philosophical evidence to affirm that psychological and conceptual-abstract realities present ontological properties that qualitatively transcend physical matter.

After Sellars, well-known critiques of ontological and epistemological reductionism from naturalistic approaches, such as the ones held by Dupré (1993), have scarcely contributed to break with the cultural perception that identifies materialism with physicalism. Dupré's process metaphysics puts processes before entities (Nicholson and Dupré 2018). But these processes are so radically plural and discontinuous that Dupré renounces to account for possible epistemological ways in which diverse disciplines could merge into unified theoretical frameworks (Bunge 2003).

The identification of materialism with physicalism lives on despite the existence of non-reductionistic and non-eliminative materialisms. Physicalism enjoys an almost total monopoly of the term "materialism" in philosophical dictionaries and encyclopedias. Current prominent critics of materialism, such as Harman (2010)⁴⁰ and Gabriel (2015, 2017) also insist in identifying materialism with reductionism, eliminativism, or both. Even more worryingly, some of the current few non-reductionist materialisms that reject physicalism, such as Quentin Meillassoux's "speculative materialism" and Jane Bennett's "new materialism", end up embracing an updated form of animism, or even spiritualism. We discuss them in what follows.

Animist-Friendly Materialism

In his allegedly materialist metaphysics, Meillassoux (2009) explicitly defends a sort of return to Hume's contingentism, in which things could be radically other than what they are or have been. He calls this ontological hypothesis the "principle of factuality" and (against Leibniz) the "principle of unreason". This principle goes as far as to reject the necessity of both physical and logical laws. Absolute reality is a hyper-chaos where contingency is absolute. Such a position implies a rejection of the traditions that, as we have seen, has been the backbone of Western metaphysics along 25 centuries. Meillassoux sole stronghold against absolute contingentism is the principle of non-contradiction. But Meillassoux's defense of a radical ontological disconnection between psychology and biology,

⁴⁰ Also, see in this volume his chapter and his discussion with Javier Pérez-Jara.

biology and chemistry, and chemistry and physics takes him as far as to totally open the door for the ontological possibility of pure spirits and gods. Moral: his “materialism” ends up being an oxymoron (for more arguments on this, see Pérez-Jara in this book).

The so-called “new materialisms”, although critical of physicalism, are equally paradoxical. They have a strong tendency towards reducing everything to socio-cultural and political practices and dynamisms. Harman (2016) has correctly seen that these “materialisms” are supported on a reductionism that “overmines” objects. In our own terms: they very often practice an upwards reductionism that ends up in a form of metaphysical holism. From our perspective, the problems of the so-called “new materialisms” run even deeper. If Meillassoux’s “speculative materialism” implicitly introduced animism, Jane Bennett’s “new materialism” explicitly embraces it. Bennett correctly critiques outdated views of matter as a passive and dull reality, in contrast to active “life”. But, following Bruno Latour’s Actor–Network–Theory (2005), she considers edibles, commodities, storms and metals as “quasi agents” (Bennett 2010). “New materialism”, of course, comes in much more varieties than just Bennett’s. But the emphasis on the agential character of matter is common to all (Coole and Frost 2010). As compelling as they are, these approaches confuse the necessary critique of matter as negativity and passivity with a neo-vitalist or neo-animist understanding of the universe. In some sense, we might say that they imply a retreat to *mythos*, an attitude that seemed superseded millennia ago.

1.9 Two Current Forms of Inclusive Materialism

Our historical approach to changing ideas of matter has demonstrated that philosophical materialism is not identical with physicalism. In this chapter (and this book) we want to emphasize two materialistic approaches relatively little known to an anglophone readership: systemic materialism and discontinuous materialism. Their main importance lies in that, contrary to the current practical monopoly of the term “materialism” by reductionist and eliminativist physicalism, both philosophical systems put forward an inclusive and non-reductionist materialism. Although both systems of thought have gone well beyond their authors, their origins and most significant developments need to be referred respectively to Mario A. Bunge (1919–2020) and Gustavo Bueno (1924–2016).

Argentinian-born Bunge has worked and lived in Canada since the mid-1960s and published most of his most relevant epistemological and ontological works in English and in conversation with the great figures of analytic philosophy of his time. Thus, some of his works have been widely debated in mainstream philosophy, particularly *Causality* (1959), *Foundations of Physics* (1967), the 8-volume *Treatise on Basic Philosophy* (1974–1989), *The Mind-Body Problem* (1980), and *Emergence and Convergence: Qualitative Novelty and the Unity of Knowledge* (2003). Furthermore, he was active until weeks before his death, at

the age of 100 years old (see his contribution to this volume, submitted shortly before he passed away). Two recent *festschrift* volumes speak of the recognition his ideas have achieved in the philosophical debate (Martino 2019 and Matthews 2019). And yet, Bunge's systemic materialism is rarely considered among the great philosophical systems of thought of the twentieth century in textbooks, compilations or encyclopedias (in the *Stanford Encyclopedia of Philosophy*, for instance, his work is only briefly discussed as part of an article on "Philosophy of Science in Latin-America").

Gustavo Bueno, on his part, worked in Spain for his entire life and published in Spanish with only few exceptions (1990). One of his books has been translated into German (2002), one into Chinese (Bueno 2012), and only two of them into English, a summary of his epistemology (*Sciences as Categorical Closures*, in 2013) and an application of his ontology to the history of philosophy (*The Happiness Delusion*, in 2019). Thus, Bueno's main ontological and epistemological contributions are hardly known outside of the Spanish-speaking world. And yet, it is our contention that his discontinuous materialism deserves a place in current debates on metaphysics.⁴¹ In particular, his *Ensayos Materialistas* (1972), *La Metafísica Presocrática* (1974), *Teoría del Cierre Categorical* (1992–1995), and *El Ego Trascendental* (2016), among others, put together an ontological and epistemological perspective with the potential of enriching the current state of the art.

In order to contribute to the demolishing of the ideological kidnapping of "materialism" by physicalism, in this chapter we will mainly stress the strong ontological and epistemological similarities between Bunge and Bueno's materialisms. Other chapters and the Discussions' section of this book's will elaborate on some significant differences between both systems. As we have stated, their common criticism of metaphysical reductionism situates both systems as *inclusive materialisms*. This means that, while rejecting spiritualism, these philosophies also *include* psychic contents as real components of some parts of the universe. While, based on incontrovertible scientific results, both Bunge and Bueno strongly defend that minds cannot exist without biological, chemical and physical processes, they also hold that such psychic contents represent a qualitative novelty that cannot be ontologically reduced to chemistry or physics. This means that, in some non-trivial way, both Bunge's and Bueno's systems can be considered as ontologically pluralist. The reason is clear: they defend (against absolute monism) that, aside of ontological continuities, there are also *structural discontinuities* in the universe (but see Ongay in this volume and the discussion between him and Pérez-Jara, also in this volume).

In addition to their common strong criticism of physicalism (which both authors considered as "vulgar materialism"), another key similarity between both thinkers is the elaboration of rigorous systems of thought supported on updated science. With such scientifically-supported philosophies, both Bunge and Bueno placed ontology

⁴¹ While Bueno himself referred to his system as "philosophical materialism" in the 1970s, as he was seeking to differentiate it from historical materialism, that conceptualization is too general and common to other philosophies; in later works, Bueno spoke of "discontinuous materialism".

and epistemology in the core of their systems. Supported on that ontological and epistemological core, they also developed their systems in other important areas of philosophy, from anthropology and politics to ethics and philosophy of economy and history. Bunge did much to move the scientificity of the social sciences forward and Bueno developed an original theory of religion.

Bunge, trained as a professional physicist, grants philosophy the key role of ordering the knowledge generated by the different sciences, coordinating it into a general and systemic view of the universe. Bueno, in turn, pictured philosophy as a “second-degree knowledge” devoted to the systematic discussion of the ideas resulting from the confrontation of the multiple “first-degree” sciences, technologies, and techniques. Also important to note is that for both authors there is a virtuous circle between sciences and philosophy, since many philosophical ideas have a strong importance in the explicit or implicit presuppositions and methodologies of scientists. Bad philosophy can lead to bad science.

Both Bunge’s “levels of emergence” and Bueno’s ontological “categories” are directly related to the distinction between the different sciences and their scales of analysis. In that sense, both thinkers have been critical of the imperialistic attempts of certain disciplines to go beyond their realms or fields of action. Thus, a chemist, for instance, cannot study biological organisms in their specificity because these ones have qualitative properties that are not reducible to chemistry. More generally: while social interactions are made by living beings that are composed of chemical elements, and these ones of physical matter, the laws of physics alone cannot take account of chemical reactions, to say nothing of psychological or sociocultural realities.

There are some important differences between Bunge’s and Bueno’s epistemologies. They revolve around specific notions of representation, truth, logical necessity, and mathematical concepts. The two authors had an intense conversation about them in Oviedo in 1982 (Hidalgo and Bueno 1982: 25–59; also, see in this volume Camprubí, Madrid, and the discussion between Madrid and Romero; see also Primero and Barrera 2019). But both authors agree, against relativism and radical constructivism, that scientific *truths* grant humans firm access to objective properties of the universe, even if those truths are always partial due to our constitutive finitude.

A relevant difference between both systems would be precisely on what they understand by the universe. Bunge defines the universe as the “system of systems” that includes everything that exists. Against any attempt of hypostatization, Bueno in turn emphasized that the universe, rather than exhausting the material reality, should be considered as a finite episode of unknown ontological processes (see Pérez-Jara in this volume).

Neither systemic materialism nor discontinuous materialism have never been presented by their authors (or by us) as concluded philosophical systems, finally culminating the long history of materialism. While they do draw (often polemically) from previous and current philosophical materialisms, no system of philosophy is

exhaustive. They are open to interpretations and discussions as well as flexible enough to adapt themselves to an ever-updating scientific reality. Along the book we will point to the issues in which contradictions or insufficient analyses invite further revisions and formulations. Through such analysis and discussions, we hope to contribute to make these two philosophical systems find the place they deserve in future discussions on materialism.

1.10 The Future of Materialism

This chapter, though ambitious, does not aim at exhausting the richness of materialist approaches, even in the realm of Western philosophy to which it limits itself. But we have endeavored to show that a valuable lesson derives from this history: that materialist philosophies are not fixed in stone. Despite the millennial critiques of spiritualism and idealism, and the identification of matter with the general features of changeability and plurality, philosophical materialisms evolve together with scientific outcomes. Reality itself poses new problems. Against neophobic metaphysics, new categories, levels, or dimensions of matter may arise, opening new problems and unveiling unforeseen objects and relationships. New technologies can also yield new versions of materialism, both as tools for research (for instance, big data offering new results in both the natural and human sciences and experimental philosophy providing empirical results to resolve ontological problems such as black holes), and by constituting new realities in themselves, such as “artificial intelligence” (AI) and the “technosphere”.

Moreover, the very history of materialism is movable. This is because philosophical history of philosophy is already mobilizing conceptions of matter, being, knowledge, and truth. Rather than from the God’s eye view, our reconstruction of the development of matter is grounded on our own inclusive materialist conception. As such, readers can judge the power of inclusive materialism by checking our historical reconstruction against the conceptual richness of the history of philosophical conceptions of matter and against other existing approaches. We hope to have complicated the picture of Greek, Christian, modern and contemporary approaches, while at the same time providing tools to navigate that complexity and built new productive approaches from it.

Conversely, if the historical reconstruction we offer here is compelling in whole or in part, this would already be an argument for the potentiality of inclusive materialisms. The future developments of materialism will rely as much on the ability to productively appropriate the philosophical tradition (including here spiritualism and idealism) as in the capacity to analyze current transformations of matter and of the sciences that study it.

References

- Abulafia, D. 2008. *The Discovery of Mankind. Atlantic Encounters in the Age of Columbus*. New Haven: Yale University Press.
- Aikin, J.M.T., and W. Johnston. 1808. *General Biography*, vol. 7. London: St. Paul Church Yard.
- Aquinas, Th. 1948. *The Summa Theologica*. New York: RCL Benziger.
- Ansey, P.R. 2017. Newton and Locke. In *The Oxford Handbook of Newton*, eds. Schliesser, E., and C. Smeenk. Oxford: Oxford University Press.
- Aristotle. 2016. *Metaphysics*. Indianapolis: Hackett Publishing Company.
- Armstrong, D.M. 1968. *A Materialist Theory of the Mind*. London: Routledge & Kegan Paul.
- Armstrong, D.M. 1997. *A World of States of Affairs*. Cambridge: Cambridge University Press.
- Ashworth, W.B. 1990. Natural history and the emblematic world view. In eds. D. Lindberg and R. Westman *Reappraisals of the Scientific Revolution*. Cambridge: Cambridge University Press.
- Avicbron (Solomon ibn Gabirol). 2014. *The Font of Life (Fons vitae)*. Milwaukee: Marquette University Press.
- Barnes, J. 1982. *The Presocratic Philosophers*. London: Routledge & Kegan Paul.
- Barrera-Osorio, A. 2007. *Experiencing nature: The Spanish American Empire and the Early Scientific Revolution*. Austin: University of Texas Press.
- Bauer, B. 1841. *Kritik der evangelischen Geschichte der Synoptiker*. Leipzig: Wigand.
- Bauer, W. 1971. *Orthodoxy and Heresy in Earliest Christianity*. Minneapolis: Fortress Press.
- Beiser, F. 2014. *After Hegel. German Philosophy 1840–1900*. Princeton: Princeton University Press.
- Bickle, J. 1992. Revisionary physicalism. *Biology and Philosophy* 7(4): 411–430.
- Blenkinsopp, J. 2011. *Creation, Un-Creation, Re-Creation: A Discursive Commentary on Genesis*, 1–11. London: T&T Clarke International.
- Borges, J.L. 1989[1952]. Nueva refutación del tiempo. In: *Otras Inquisiciones*. In: *Obras Completas*. Buenos Aires: Emecé, 1989. Vol. 2, p. 146.
- Bourke, V.J. 2019. *Augustine's Quest of Wisdom: The Life and Philosophy of the Bishop of Hippo*. Providence: Cluny Media LLC.
- Bowman, C., and Y. Estes (eds.). 2016. *J. G. Fichte and the Atheism Dispute (1798–1800)*. New York: Routledge.
- Broda, E. 1983. *Ludwig Boltzmann*. Woodbridge: Ox Bow Press.
- Bryant, L. 2014. Correlationism. In *The Meillassoux Dictionary*, eds. Gratton, P. and P.J. Ennis. Edinburgh: Edinburgh University Press.
- Brakke, D. 2012. *The Gnostics: Myth, Ritual, and Diversity in Early Christianity*. Harvard: Harvard University Press.
- Bruno, G.A. (ed.). 2020. *Schelling's Philosophy: Freedom, Nature, and Systematicity*. Oxford: Oxford University Press.
- Büchner, L. 1904[1855]. *Kraft und Stoff oder Grundzüge der natürlichen Weltordnung*, 21st ed. Leipzig: Theodore Thomas.
- Bueno, G. 1972. *Ensayos Materialistas*. Madrid: Taurus.
- Bueno, G. 1974. *La Metafísica Presocrática*. Oviedo: Pentalfa.
- Bueno, G. 1981. Introducción a la *Monadología*. In Leibniz, *Monadología*. Oviedo: Pentalfa, p. 11–47.
- Bueno, G. 1989. La teoría de la esfera y el descubrimiento de América. *El Basilisco* 1: 3–32.
- Bueno, G. 1990a. Ganzes/Teil. Holismus. Materie. Naturwissenschaften. *Europäische Enzyklopädie zu Philosophie und Wissenschaften*. Hamburg: Felix Meiner Verlag.
- Bueno, G. 1990b. *Materia*. Oviedo: Pentalfa.
- Bueno, G. 1992–1993. *Teoría del cierre categorial*, vol 5. Oviedo: Pentalfa.
- Bueno, G. 1996. *El Sentido de la Vida. Seis Lecturas de Filosofía Moral*. Oviedo: Pentalfa.
- Bueno, G. 2007. *La Fe del Ateo*. Madrid: Temas de Hoy.
- Bueno, G. 2008. La vuelta del revés de Marx. *El Catoblepas* 76. <http://nodulo.org/ec/2008/n076p02.htm>.

- Bueno, G. 2012. 看西班牙. Nankin: Nanking University.
- Bueno, G. 2016. *El Ego Trascendental*. Oviedo: Pentalfa.
- Bueno, G. 2019. *The Happiness Delusion. Debunking the Myth of Happiness*. Oviedo: Pentalfa.
- Bunge, M. 2003. *Emergence and Convergence: Qualitative Novelty and the Unity of Knowledge*. Toronto: University of Toronto Press.
- Bunge, M. 2006. *Chasing Reality: Strife over Realism*. Toronto: University of Toronto Press.
- Bunge, M. 2009[1959]. *Causality and Modern Science: Fourth Revised Edition*. New Brunswick: Transaction Publishers.
- Bunge, M. 2010. *Matter and Mind: A Philosophical Inquiry*. New York: Springer.
- Camprubí, L. 2009. Traveling around the Empire: Iberian voyages, the sphere, and the Atlantic origins of the Scientific Revolution. *Eñ, Revista de Humanidades Médicas & Estudios Sociales de la Ciencia y la Tecnología* 1(2): 1–19.
- Carabine, D. 2015. *The Unknown God: Negative Theology in the Platonic Tradition: Plato to Eriugena*. Eugene: Wipf and Stock.
- Carnap, R. 1959[1932/1933]. Psychology in physical language. In *Logical Positivism*, ed. A.J. Ayer. New York: The Free Press.
- Cañizares-Esguerra, J. 2006. *Nature, Empire and Nation: Explorations of the History of Science in the Iberian World*. Stanford: Stanford University Press.
- Cao, T.Y. 1997. *Conceptual Development of 20th Century Field Theories*. Cambridge: Cambridge University Press.
- Chemla, K. 2012. *The History of Mathematical Proof in Ancient Traditions*. Cambridge: Cambridge University Press.
- Childe, V.G. 2009[1958]. *The Prehistory of European Society*. London: Spokesman Press.
- Childe, V.G. 2017[1951]. *Social Evolution*. Delhi: Aakar Books.
- Churchland, P.S. 1981. Eliminative materialism and the propositional attitudes. *Journal of Philosophy* 78(2): 67–90.
- Churchland, P.S. 1986. *Neurophilosophy: Toward a Unified Science of the Mind/Brain*. Cambridge: MIT Press.
- Churchland, P.S., and T.J. Sejnowski. 1993. *The Computational Brain*. Cambridge: MIT Press.
- Churchland, P.M. 1984. *Matter and Consciousness: A Contemporary Introduction to the Philosophy of Mind*. Cambridge: MIT Press.
- Chryssavgis, J. 2008. *In the Heart of the Desert: The Spirituality of the Desert Fathers and Mothers*. Bloomington: World Wisdom.
- Clark, S. 1997. *Thinking with Demons: The Idea of Witchcraft in Early Modern Europe*. Oxford: Clarendon.
- Coakley, J.W., and A. Sterk (eds.). 2004. *Readings in World Christian History*. New York: Orbis Books.
- Coole, D., and S. Frost (eds.). (2010). *New Materialisms: Ontology, Agency, and Politics*. Durham: Duke University Press Books.
- Copleston, F. 1993[1955]. *A History of Philosophy, Vol. 1: Greece and Rome From the Pre-Socratics to Plotinus*. New York: Image.
- Coxon, A.H. 2009. *The Fragments of Parmenides: A Critical Text with Introduction*. Athens: Parmenides Publishing.
- Critchley, S. 2019. *Tragedy, the Greeks, and Us*. New York: Pantheon.
- Crombie, A.C. 1953. *Robert Grosseteste and the Origins of Experimental Science, 1100–1700*. Oxford: Clarendon Press.
- Daston, L. 1991. Marvelous Facts and Miraculous Evidence in Early Modern Europe. *Critical Inquiry* 18(1): 93–124.
- Daston, L. and Park, K. 1998. *Wonders and the Order of Nature. 1150–1750*. New York: Zone Books.
- Davies, S. 2016. *Renaissance Ethnography and the Invention of the Human. New Worlds, Maps and Monsters*. Cambridge: Cambridge University Press.

- Day, J. 2002. *Yahweh and the Gods and Goddesses of Canaan*. Sheffield: Sheffield Academic Press.
- Day, J. 2015. *From Creation to Babel: Studies in Genesis 1–11*. Edinburgh: Bloomsbury T&T Clark.
- Dennett, D. 1991. *Consciousness Explained*. Boston: Little, Brown.
- Díaz Díaz, G. 2003. *Hombres y Documentos de la Filosofía Española: S-Z: Vol. VII*. Madrid: Consejo Superior De Investigaciones Científicas.
- Dionysius the Areopagite. 2004. *On the Divine Names and the Mystical Theology*, trans. C. E. Rolt. Lake Worth: Nicolas Hays.
- Dupré, J. 1993. *The Disorder of Things: Metaphysical Foundations of the Disunity of Science*. Cambridge: Harvard University Press.
- Dunn, G. D. 2004. *Tertullian*. New York: Routledge.
- Engels, F. 2012[1883]. *Dialectics of Nature*. London: Wellred.
- Fagenblat, M. Ed. 2017. *Negative Theology as Jewish Modernity*. Bloomington: Indiana University Press.
- Feingold, M. Ed. 2003. *Jesuit Science and the Republic of Letters*. Cambridge: The MIT Press.
- Fichte, J. G. 1982[1794]. *The Science of Knowledge: With the First and Second Introductions*. Cambridge: Cambridge University Press.
- Fichte, J.G. 2000[1797]. *Foundations of Natural Right*. Cambridge: Cambridge University Press.
- Fichte, J.G. 2009[1868]. *The Science of Knowledge*. Ithaca: Cornell University Library.
- Fichte, J.G. 2010[1792]. *Attempt at a Critique of All Revelation*. Cambridge: Cambridge University Press.
- Frauenstädt, J. 1856. *Der Materialismus. Seine Wahrheit und sein Irrthum. Eine Erwiderung auf Dr. L. Büchner's "Kraft und Stoff"*, Leipzig: Brockhaus.
- Freeman, C. 2011. *A New History of Early Christianity*. New Haven: Yale University Press.
- Gabriel, M. 2017. *I am Not a Brain: Philosophy of Mind for the 21st Century*. Cambridge: Polity.
- Gabriel, M. 2015. *Why the World Does Not Exist*. Cambridge: Polity.
- García Valverde, J.M., P. Maxwell-Stuart, 2019. *Gomez Pereira's Antoniana Margarita. A Work on Natural Philosophy, Medicine and Theology*. Leiden: Brill.
- Geest, P.V. 2011. *The Incomprehensibility of God: Augustine as a Negative Theologian*. Leuven: Peeters Publishers.
- Gilson, E.H. 1960. *The Christian Philosophy of Saint Augustine*. New York: Random House.
- Goetschel, W. 2004. *Spinoza's Modernity: Mendelssohn, Lessing, and Heine*. Madison, Wisconsin: University of Wisconsin Press.
- Gómez Pereira, A. 2000 [1554]. *Antoniana Margarita*. Santiago de Compostela: USC-Fundación Gustavo Bueno.
- Grafton, A. 1992. *New Worlds, Ancient Texts: The Power of Tradition and the Shock of Discovery*. Cambridge: Harvard University Press.
- Grafton, A., and G. Siraisi (eds.). 2000. *Natural Particulars: Nature and the Disciplines in Renaissance Europe*. Cambridge: The Mit Press.
- Graham, D.W. 2006. *Explaining the Cosmos*. Princeton: Princeton University Press.
- Graham, D.W. 2010. *The Texts of the Early Greek Philosophy*, Part I. Cambridge: Cambridge University Press.
- Graham, D.W. 2013. *Science before Socrates*. Oxford: Oxford University Press.
- Grant, E. 2001. *God and Reason in the Middle Ages*. Cambridge: Cambridge University Press.
- Gregory, F. 1977. *Scientific Materialism in Nineteenth Century Germany*. Dordrecht: Reidel.
- Gutas, D. 2014. *Orientalism of Avicenna's Philosophy: Essays on his Life, Method, Heritage*. New York: Routledge.
- Haaparanta, L., and Koskinen, H.J. (eds.). 2012. *Categories of Being: Essays on Metaphysics and Logic*. Oxford: Oxford University Press.
- Harman, G. 2010. I am also of the opinion that materialism must be destroyed. *Environment and Planning D: Society and Space* 28(5): 772–790.
- Harman, G. 2016. *Immaterialism: Objects and Social Theory*. Cambridge: Polity.
- Harman, G. 2009. *Prince of Networks: Bruno Latour and Metaphysics*. Melbourne: Re.press

- Harman, G. 2011. *The Quadruple Object*. United Kingdom: Zero Books.
- Harris, M. 1979. *Cultural Materialism: The Struggle for a Science of Culture*. New York: Random House.
- Harrison, P. 2015. *The Territories of Science and Religion*. Chicago: University of Chicago Press.
- Hegel, G.W.F. 1977[1807]. *Phenomenology of Spirit*. Oxford: Oxford University Press.
- Hegel, G.W.F. 1991[1820]. *Elements of the Philosophy of Right*. Cambridge: Cambridge University Press.
- Hegel, G.W.F. 2015a[1817]. *Encyclopedia of the Philosophical Sciences*. Cambridge: Cambridge University Press.
- Hegel, G.W.F. 2015b[1816]. *The Science of Logic*. Cambridge: Cambridge University Press.
- Heidegger, M. 1997[1929]. *Kant and the Problem of Metaphysics*. Bloomington: Indiana University Press.
- Hempel, C. 1949[1980]. The logical analysis of psychology. In *Readings in the Philosophy of Psychology*, ed. N. Block, Vol. 1, Cambridge: Harvard University Press.
- Henry, J. 2008. *The Scientific Revolution and the Origins of Modern Science*, 3rd edn. New York: Palgrave Macmillan.
- Hesse, M.B. 2005. *Forces and Fields*. New York: Dover.
- Hevia Echeverría, J. 2007. La concordia de Molina, en Luis de Molina, *Concordia del libre arbitrio* [1588]. Oviedo: Pentalfa.
- Hidalgo, A., and S.G. Bueno 1982. *I Congreso de Teoría y Metodología de las Ciencias*. Oviedo: Pentalfa.
- Hume, D. 2000[1739]. *A Treatise of Human Nature*. Oxford: Oxford University Press.
- Insua, P. 2018. *El orbe a sus pies: Magallanes y Elcano: cuando la cosmografía española midió el mundo*. Madrid: Ariel.
- Innocent III (Lotario Dei Segni). 1977. *De Miseria Conditionis Humane*. Georgia: University of Georgia Press.
- Jacob, M. 2019. *The Secular Enlightenment*. Princeton: Princeton University Press.
- Jacobi, F.H. 1799. *Jacobi an Fichte*. Hamburg: Perthes.
- Jaeger, W. 2003[1936]. *The Theology of the Early Greek Philosophers*. Eugene: Wipf and Stock.
- James, C.L.R. 1980[1948]. *Notes on Dialectics: Hegel, Marx, Lenin*. London: Allison & Busby.
- Jarochevski, M. 1975. *Psychologie im 20. Jahrhundert*. Berlin: Volk und Wissen.
- Johnston, W.M. 2013. *Encyclopedia of Monasticism*. New York: Routledge.
- Josephson-Storm, J. 2017. *The Myth of Disenchantment: Magic, Modernity, and the Birth of the Human Sciences*. Chicago: University of Chicago Press.
- Kahn, C.H. 1994. *Anaximander and the Origins of Greek Cosmology*. Cambridge : Indianapolis Hackett Publishing.
- Kant, I. 1998[1793]. *Religion within the Boundaries of Mere Reason*. Cambridge: Cambridge University Press.
- Kant, I. 2007[1790]. *Critique of Judgment*. Oxford: Oxford University Press.
- Kant, I. 2008[1787]. *Critique of Pure Reason*. London: Penguin Classics.
- Kant, I. 2015[1788]. *Critique of Practical Reason*. Cambridge: Cambridge University Press.
- Kars, A. 2019. *Unsayings God: Negative Theology in Medieval Islam*. Oxford: Oxford University Press.
- Kirk, G.S., J. Raven, and M. Schofield. 1983. *The Presocratic Philosophers*. Cambridge: Cambridge University Press.
- Kirsch, J. 2005. *God Against the Gods: The History of the War Between Monotheism and Polytheism*. London: Penguin Books.
- Klein, J. 2008. Francis Bacon's Scientia Operativa, the tradition of the workshops, and the secrets of Nature. In *Philosophies of Technology. Francis Bacon and His Contemporaries*, eds. C. Zittel, G. Engel, R. Nanni, and N.C. Karafyllis Leiden: Brill, p.21–49.
- Kojevnikov, A. 2004. *Stalin's Great Science: The Times and Adventures of Soviet Physicists*. London: Imperial College Press.
- Lange, F. 1866. *Geschichte des Materialismus und Kritik seiner Bedeutung in der Gegenwart*. Iserlohn: J. Baedeker.

- Latour, B. 2005. *Reassembling the Social: An Introduction to Actor–Network–Theory*. Oxford: Oxford University Press.
- Lenin, V.I. 2011[1909]. *Materialism and Empirio-Criticism: Critical Comments on A Reactionary Philosophy*. Whitefish: Literary Licensing, LLC.
- Leshner, J.H. 1992. *Xenophanes of Colophon: Fragments: A Text and Translation with Commentary*. Toronto: University of Toronto Press.
- Lindberg, D.C. 2007. *The Beginnings of Western Science*, Chicago: Chicago University Press.
- Long, A.A. 1974. *Hellenistic Philosophy: Stoics, Epicureans and Sceptics*. London: Duckworth.
- Long, A.A., and D.N. Sedley. 1987. *The Hellenistic Philosophers*. Cambridge: Cambridge University Press.
- Long, A.A. (ed.) 1999. *The Cambridge Companion to Early Greek Philosophers*. Cambridge: Cambridge University Press.
- Loraux, N. 2002. *The Mourning Voice: An Essay on Greek Tragedy*. Cornell: Cornell University Press.
- MacCulloch, D. 2010. *Christianity: The First Three Thousand Years*. London: Penguin.
- MacMullen, R. 1984. *Christianizing the Roman Empire: A.D. 100–400*. New Haven: Yale University Press.
- Martino, A.A. (ed.) 2019. *El Último Ilustrado. Libro de Homenaje al Centenario del Nacimiento de Mario A. Bunge*. Buenos Aires: Eudeba.
- Marx, K. 1975[1841], in: *Collected Works of Karl Marx and Frederick Engels: Volume 1*. New York: International Publishers.
- Marx, K. 2014[1844]. *Critique of Hegel's Philosophy of Right*. Seattle: Amazon.
- Marx, K., and F. Engels. 1976. *Collected Works of Karl Marx and Friedrich Engels, 1845–47, Vol. 5: Theses on Feuerbach, The German Ideology and Related Manuscripts*. New York: International Publishers Co.
- Matthews, M.R. (ed.) 2019. Ed. *Mario Bunge: A Centenary Festschrift*. Cham: Springer.
- May, G. 2004. *Creatio Ex Hihilo*. London: Continuum International.
- McClendon, J.H.III. 2004. *C.L.R. James's Notes on Dialectics: Left Hegelianism or Marxism-Leninism?* Washington: Lexington Books.
- McKirahan, R.D. 1994. *Philosophy before Socrates*. Cambridge: Indianapolis Hackett Publishing Co.
- Meillassoux, Q. 2009. *After Finitude: An Essay on the Necessity of Contingency*. London: Continuum.
- Meli D.B. 2006. *Thinking with Objects. The Transformation of Mechanics in the Seventeenth Century*. Baltimore: John Hopkins University Press.
- Nicholson, D.J., and J. Dupré. 2018. *Everything Flows: Towards a Processual Philosophy of Biology*. Oxford: Oxford University Press.
- Nebe, G. 2002. Creation in Paul's theology. In *Creation in Jewish and Christian Tradition*, eds. Y. Hoffman, H.G. Reventlow. Sheffield: Sheffield Academic Press.
- Nestle, W. 1975[1940]. *Vom Mythos zum Logos; Die Selbstenfaltung Des Griechischen Denkens*. Stuttgart: Alfred Kroner Verlag.
- Netz, R. 1999. *The Shaping of Deduction in Greek Mathematics. A Study in Cognitive History*. Cambridge: Cambridge University Press.
- Neurath, O. 1983[1931]. Physicalism: the philosophy of the vienna circle. In *Philosophical Papers 1913–1946*, eds. R.S. Cohen, M. Neurath. Dordrecht: D. Reidel Publishing Company.
- Newman, W. 2006. *Atoms and Alchemy. Chymistry and the Experimental Origins of the Scientific Revolution*. Chicago: The University of Chicago Press.
- North, J. 1994. *The Fontana History of Astronomy and Cosmology*. Fontana Press.
- Ongay, I. 2019. Mente y materia: una revisión de la filosofía de la mente de Mario Bunge. In *El Último Ilustrado. Homenaje al Centenario del Nacimiento de Mario A. Bunge*, ed. Antonio Martino. Buenos Aires: Eudeba.
- O'Rourke, Fran. 2016. *Pseudo-Dionysius and the Metaphysics of Aquinas*. Notre Dame: University of Notre Dame Press.

- Padgen, A. 1982. *The Fall of Natural Man: The American Indian and the Origins of Comparative Ethnology*. Cambridge: Cambridge University Press.
- Papandrea, J.L. 2016. *The Earliest Christologies: Five Images of Christ in the Postapostolic Age*. Downers Grove: IVP Academic.
- Pardo J. 2002. *Oviedo, Monardes, Hernández: El Tesoro Natural de América, Colonialismo y Ciencia en el Siglo XVI*. Madrid: Nivola.
- Pasternack, L. 2013. *Routledge Philosophy Guidebook to Kant on Religion within the Boundaries of Mere Reason*. New York: Routledge.
- Peña, V. 1974. *El Materialismo de Spinoza. Ensayo sobre la Ontología Spinozista*. Madrid: Revista de Occidente.
- Pereira, G. 2019[1554]. *Antoniana Margarita: A Work on Natural Philosophy, Medicine and Theology*. Leiden: Brill Academic Pub.
- Pérez-Jara, J. 2011. La importancia del cuerpo como “constitutivo formal” de todo viviente en la filosofía de Schopenhauer. *Thémata. Revista de filosofía*: 424–438.
- Pérez-Jara, J. 2014. *La Filosofía de Bertrand Russell*. Oviedo: Pentalfa.
- Peeters, E., L.V. Molle, and K. Wils (eds.). 2011. *Beyond Pleasure: Cultures of Modern Asceticism*. New York: Berghahn Books.
- Pimentel, J. 2001. The Iberian vision: Science and empire in the framework of a Universal monarchy, 1500–1800. In *Nature and Empire: Science and the Colonial Enterprise, Osiris Special Issue, 15*, ed. R. MacLeod, p. 17–30.
- Place, U.T. 1956. Is consciousness a brain process? *British Journal of Psychology* 47: 44–50.
- Portuondo, M. 2009. *Secret Science. Spanish Cosmography and the New World*. Chicago: Chicago University Press.
- Primero, G., and S. y Barrera. 2019. El concepto de materia en los sistemas filosóficos de Gustavo Bueno y Mario Bunge. *Scientia in Verba* 3: 34–52.
- Purrington, R.D. 1997. *Physics in the Nineteenth Century*. New Jersey: Rutgers University Press.
- Ramsey, W., S. Stich, and J. Garon. 1990. Connectionism, eliminativism and the future of folk psychology. *Philosophical Perspectives* 4: 499–533
- Randall, J.H. 1958. *The Role of Knowledge in Western Religion*. Boston: Starr King Press
- Robinson, Th.A., and H.P. Rodrigues. 2014. *World Religions: A Guide to the Essentials*. Ada: Baker Academic.
- Rocca, G.P. 2008. *Speaking the Incomprehensible God: Thomas Aquinas on the Interplay of Positive and Negative Theology*. Washington: The Catholic University of America Press.
- Rogers, A.J. 1978. Locke’s Essay and Newton’s Principia. *Journal for the History of Ideas* 39(2): 217–232.
- Romero, G.E. 2012. Parmenides reloaded. *Foundations of Science* 17: 291–299.
- Romero, G.E. 2013. From change to spacetime: An eleatic journey. *Foundations of Science* 18: 139–148.
- Romero, G.E. 2016. A formal ontological theory based on timeless events. *Philosophia* 44: 607–622.
- Romero, G.E. 2018. *Scientific Philosophy*. Cham: Springer.
- Roem, P. 1993. *Pseudo-Dionysius: A Commentary on the Texts and an Introduction to Their Influence*. Oxford: Oxford University Press.
- Rorty, R. 1970. In defense of eliminative materialism. *The Review of Metaphysics* XXIV.
- Rosental, M., and P. Yudin. 1945[1940]. *Diccionario de Filosofía*. Santiago de Chile: Nueva América.
- Russell, B. 1972[1945]. *A History of Western Philosophy*. New York: Touchstone.
- Schelling, F.W.J. 2012[1842]. *Historical-Critical Introduction to the Philosophy of Mythology*. Albany: SUNY Press.
- Schelling, F.W.J. 2009[1804]. *Philosophy and Religion*. Ashland: Spring Publications.
- Schopenhauer, A. 2014[1859]. *The World as Will and Representation, Vol. I*. Cambridge: Cambridge University Press.
- Schopenhauer, A. 2016[1851]. *Parerga and Paralipomena: Short Philosophical Essays, Vol. I*. Cambridge: Cambridge University Press.

- Schopenhauer, A. 2017[1851]. *Parerga and Paralipomena: Short Philosophical Essays, Vol. II*. Cambridge: Cambridge University Press.
- Schopenhauer, A. 2018[1859]. *The World as Will and Representation, Vol. II*. Cambridge: Cambridge University Press.
- Searle, J.R. 1992. *The Rediscovery of the Mind*. Cambridge: MIT Press.
- Searle, J.R. 1995. *The Construction of Reality*. New York: The Free Press.
- Searle, J.R. 1997. *The Mystery of Consciousness*. New York: New York Review.
- Searle, J.R. 2005. *Mind: A Brief Introduction*. Oxford: Oxford University Press.
- Searle, J.R. 2007. *Freedom & Neurobiology*. New York, NY: Columbia University Press.
- Sellars, R.W. 1969[1922]. *Evolutionary Naturalism*. New York: Russell & Russell.
- Sellars, R.W. 1970. *Principles of Emergent Realism*. St. Louis: Warren H Green.
- Shapin, S., and S. Schaffer. 1985. *Leviathan and the Air-Pump, Hobbes, Boyle, and the Experimental Life*. New Jersey: Princeton University Press.
- Sheehan, Th. 2014. *Making Sense of Heidegger: A Paradigm Shift*. Lanham: Rowman & Littlefield.
- Slaveva-Griffin, S., and P. Remes. 2017. *The Routledge Handbook of Neoplatonism*. New York: Routledge.
- Smart, J.C.C. 1963. *Philosophy and Scientific Realism*. New York: The Humanities Press.
- Smith, P.H. 2004. *The Body of the Artisan: Art and Experience in the Scientific Revolution*. Chicago: The University of Chicago Press.
- Smith, C., and M.N. Wise. 1989. *Energy and Empire: A Biographical Study of Lord Kelvin*. Cambridge: Cambridge University Press.
- Strauss, D.F. 1835. *Das Leben Jesu, kritisch bearbeitet*. Tübingen: C. F. Osiander.
- Strawson, P. 2018. *The Bounds of Sense: An Essay on Kant's Critique of Pure Reason*. New York: Routledge.
- Taylor, C.C.W. 1999. *The Atomists: Leucippus and Democritus*. Toronto: The University of Toronto Press.
- Thomson, A. 2014. French eighteenth-century materialists and natural law. *History of European Ideas* 42(2): 1–13.
- Van Melsen, A.G. 2004. *From Atomos to Atom*. New York: Dover.
- Vermeir, K. 2011. Wonder, magic, and natural philosophy. The disenchantment thesis revisited in eds. M. Deckard and P. Losonczi *Philosophy Begins in Wonder*. Eugene: Wipf and Stock, p. 43–71.
- Vogt, C. 1855. *Kühlerglaube und Wissenschaft: Eine Streitschrift gegen Hofrath Wagner in Göttingen*. Gießen: Ricker.
- von Wahlde, U.C. 2015. *Gnosticism, Docetism, and the Judaisms of the First Century: The Search for the Wider Context of the Johannine Literature and Why It Matters*. London: T&T Clark.
- Wallis, R.T. 1995. *Neoplatonism*. Indianapolis: Hackett Publishing Company.
- Weber, M. 1946[1918]. Science as vocation. In *From Max Weber: Essays in Sociology*, eds. H. Gerth and C. Wright Mills. New York: Free Press.
- Weeks, A. 1997. *Paracelsus. Speculative Theory and the Crisis of the Early Reformation*. Albany: State University of New York.
- Weidemann, H.U. (ed.). 2013. *Asceticism and Exegesis in Early Christianity: Reception and Use of New Testament Texts in Ancient Christian Ascetic Discourses*. Göttingen: Vandenhoeck & Ruprecht.
- Westfall, R.S. 1983. *Never At Rest: A Biography of Isaac Newton*. Cambridge: Cambridge University Press.
- White, L.A. 2007[1959]. *The Evolution of Culture*. New York: Routledge.
- Wise, M.N. 2018. *Aesthetics, Industry and Science. Hermann von Helmholtz and the Berlin Physical Society*. Chicago: Chicago University Press.
- Wooton, D. 2015. *The Invention of Science: A New History of the Scientific Revolution*. London: Penguin.
- Young, F. 1991. 'Creatio Ex Nihilo': A context for the emergence of the Christian doctrine of Creation. *Scottish Journal of Theology* 44: 139–152.

- Yourgrau, W., A. van der Merwe, and G. Raw. 1982. *Treatise on Irreversible and Statistical Thermophysics*. New York: Dover.
- Zizek, S. 2013. *Less Than Nothing: Hegel and the Shadow of Dialectical Materialism*. New York: Verso Books.

Chapter 2

Systemic Materialism



Gustavo E. Romero

Abstract I present a condensed *exposé* of systemic materialism, a synthesis of materialism and systemism originally proposed by Mario Bunge. Matter is identified with mutability of propertied particulars, and a concrete or material system is defined as an object with composition, structure, mechanism, and environment. I review different aspects of this ontology, and discuss some of its implications for epistemology, ethics, and aesthetics. I also try to identify some problems of this view and offer some ways to overcome the difficulties. I conclude that systemic materialism is a promising philosophical project still in the making.

2.1 Introduction

Systemic materialism, also known as emergent materialism, is a collection of ontological views mainly developed by the Argentine-Canadian philosopher and physicist Mario Bunge (1919–2020). Bunge was trained as a physicist (his PhD thesis on the kinematics of the relativistic electron was supervised by Guido Beck, who was research assistant to Heisenberg in Leipzig). Very early in his career Bunge displayed a strong interest in philosophy and, in particular, ontology (Bunge 2016). In the 1950s he published papers on the concept of chance, philosophy of physics (especially quantum mechanics) and causality (e.g. Bunge 1951, 1959). By the early 1960s Bunge was a well-established philosopher. In that decade he published two seminal books: *Foundations of Physics* (Bunge 1967a) and *Scientific Research* (1967b).

Foundations was an in-depth analysis of all major theories of physics, where Bunge attempted to implement a rigorous axiomatization of the formalism of

G. E. Romero (✉)

Instituto Argentino de Radioastronomía (IAR) (CONICET; CICPBA; UNLP), Villa Elisa, Buenos Aires, Argentina

Facultad de Ciencias Astronómicas y Geofísicas, Universidad Nacional de La Plata, La Plata, Provincia de Buenos Aires, Argentina

© Springer Nature Switzerland AG 2022

G. E. Romero et al. (eds.), *Contemporary Materialism:*

Its Ontology and Epistemology, Synthese Library 447,

https://doi.org/10.1007/978-3-030-89488-7_2

various theories in an attempt to clarify their interpretations. The second chapter of this book was a programmatic research project of all major branches of philosophy, including philosophical semantics, ontology, and epistemology (see Romero 2019a for an assessment of the achievements of *Foundations of Physics*). Bunge's ambitious philosophical view was then fully developed along the next two decades in the 8-volume *Treatise on Basic Philosophy* (1974–1989). The third and fourth volumes of this monumental work were devoted to ontology and contain the most detailed exposition of his materialist metaphysics (Bunge 1977, 1979). These views were later expanded and refined in a series of important books (Bunge 1981, 2003a, 2006, 2010) and many papers (a full bibliography of Mario Bunge is given by Silberstein 2019; an almost complete catalog of his writings, including correspondence, can be found in Huerta Martín 2019).

Bunge's version of materialism is distinctive in several aspects. Perhaps the most noteworthy feature is his rejection of physicalism and his emphasis on the concept of emergence. Bunge considers that reality is organized in different levels, all of them material. Although he regards the physical level as the most basic one, the higher levels are populated by material systems endowed with peculiar properties (some of them not belonging to the physical substratum) that emerge from the interactions among the components of the systems and from the interactions between system and its environment. Bunge tries to formalize his theory of material systems along with the concepts of ontological composition, mechanism, emergence, and ontological levels in several of his books. Although Bunge sometimes talks of matter as some kind of substance and occasionally claimed to be monist, I will argue below that his views are consistent with a materialist pluralism. In this sense there are some similarities with the materialism of the Spanish philosopher (Buena 1972; see also the chapter by Pérez Jara on discontinuous materialism in this volume). More clearly, Bunge's views are related to those of Roy Wood Sellars, who in the early twentieth century defended materialism and emergence, along with realism (Sellars 1969 [1922], 1970). Bunge's debts with Aristotle, Paul Henri Thiery (Baron d'Holbach), Karl Marx, and Hans Vaihinger are also important.¹ Bunge's inclination toward the use of formal tools in philosophy are mostly due to his fondness of the work of Hilbert, and his familiarity with some classical works of Beth (1964) and Martin (1958).

Another key feature of Bunge's ontology is that it is formulated as a hypothetic-deductive system. The hypotheses are informed by our best current scientific theories and are not intended as a part of a dogmatic system, but as provisional propositions that might be revised in the light of potential disagreements with science. The test for an ontological theory, according to Bunge, is internal coherence, agreement with scientific knowledge, and fertility for cognitive advances. Since

¹ Bunge rarely mentioned Vaihinger in his publications, although he was clear in private conversations with the author about the importance he gave to some ideas that Vaihinger expressed in his book *The Philosophy of 'As If'* (Vaihinger 1911), and the impact these ideas had on his views on the nature of mathematics.

scientific knowledge is movable, so it should be the ontology. Actually, as I will show in this paper, some of Bunge's views should be adjusted to follow recent developments in gravitational physics and research in quantum gravity.

Bunge himself was prone to introduce changes to keep the pace of scientific advance. As a trained research scientist and an indefatigable reader of scientific journals, he was well-equipped for the task. As time went by, however, it was the task of other philosophers to explore the implications of his ontology and to make changes and adjustments. In the last few years, many papers and books have expanded Bunge's ontological views in new directions (e.g. Marquis 2011; Romero 2018a; Wang 2011, and the many papers included in Weingartner and Dorn 1990 and Matthews 2019).

In this chapter I will try to present the basics of systemic materialism to the general reader. I will offer definitions of the main concepts, I will try to show how this ontology is articulated into a coherent system, and I will try to illustrate how some traditional problems are dealt with in this worldview. I will discuss how, in my view, some positions defended by Bunge should be adjusted in the face of criticisms and new scientific developments. From the beginning I waive any claims to completeness. By the end, nevertheless, I hope to have conveyed the idea that materialism remains as a very powerful and down-to-earth ontology.²

2.2 The Concept of Matter

Basic research shows that the universe is populated by a huge number of particular entities. These entities cannot just be, without further qualification; they must be one way or other. These ways of being are called 'properties'. Basic entities, entities that are not formed by anything else, are called 'substances'.³ Substances are mereologically simples. Substances and properties are complementary in the sense that there are not unpropertied substances or orphan properties. What actually exists are always some substances that are in one way or another. Substances are not bearers of properties, or bundles of properties, or can fail to be propertied. Properties, on the other hand, are not parts of substances; they are just the way substances manifest. Substances and properties cannot be separated except by a conceptual operation of abstraction: they are complementary categories of being (Heil 2012).

² I will not necessarily follow Bunge's nomenclature. What I am presenting is not a transcription of Bunge's views, but rather a simplified and updated version of systemic materialism. If the reader wants to compare my presentation with Bunge's own views, I recommend to go to his *Treatise* (Bunge 1977, 1979) and his books *Scientific Materialism* and *Mind and Matter* (Bunge 1981 and 2010, respectively).

³ Bunge uses the term 'individual', but since individuals can be conceptual or abstract as well, I prefer to use the traditional word 'substance' to designate basic, non-reducible stuff, following Heil (2012).

Properties should not be confused with predicates. Predicates are conceptual tools we use to represent properties when we talk about the world. Nor should properties be conceived as universals that are shared by some particulars. Rather, they are the specific *modes* particulars are.

All substances are simple: they have no parts. However, substances can combine to form more complex entities. We call these entities *things*. Examples of things are planets, chairs, human beings, books, galaxies, and rocks. Substances themselves can be defined as basic or elementary things. Although there are no complex substances, things can be very complex. Things with parts are called *systems*, and I will discuss them in more detail below. For now suffice to say that systems also have properties. Some of these properties are inherited from the composing substances and some others are specific of the system. These specific properties arise by a process called *emergence* (see Sect. 2.5).

Any system has properties. The collection of these properties conforms the *state* of the system and this state can *change*. A change can be construed as a displacement in a *space of states*. Usually, a state space has many dimensions, one per property. If we quantify the properties, for instance representing them by mathematical functions, then the evolution of the thing will be represented by a trajectory in a functional space that represents the state space. At this point we can introduce a definition of matter in the following way.

Definition 1 Let be x a thing (either basic or complex), y some other thing considered as a reference frame, and $S_y(x)$ the state space of x with respect to y . Then, x is material if, and only if, $S_y(x)$ contains more than one element.

More briefly, if Mx means ‘ x is material’, then

$$Mx \stackrel{\text{def}}{=} \exists y (|S_y(x)| \geq 2). \quad (2.1)$$

Some comments are in order. Material simple things do not exist in absolute isolation, because otherwise there would be no reference frame with respect to which the thing might change. In the absence of another thing, even intrinsic changes are meaningful only if the thing has parts, i.e. if it is not simple. It might be objected that a simple thing, for instance a muon, might exist in isolation and then decay producing changes. However, the changes are determined with respect to the decay products. In four dimensions, there are 4, not just 1 basic thing. The decay chain of the muon is $\mu \rightarrow e^- + \nu_\mu + \bar{\nu}_{e^+}$. The products on the right side are an electron, a muon neutrino, and anti-electron neutrino. In the state space the decay occupies more than a single point.

Another relevant comment is that change always requires energy. Energy is the most universal property of things: it is the ability to change, i.e. to do work. Hence, Bunge offers an alternative definition of material thing in the following way (Bunge 2003b):

Definition 2 $Mx \stackrel{\text{def}}{=} E(x)$,
where $E(x)$ means ‘ x has energy E ’.

I note that (1) Energy is a property, not a thing. Hence, there is no ‘pure energy’. Energy is always associated with some thing. (2) To have zero energy is not the same as having no energy. Having no energy amounts to non-existence as a material being.⁴ But a given material system, the universe for instance, can have equal amounts of positive and negative energy so the total sum can be zero. (3) Although all objects with mass have energy and then they are material, the converse is not true: there are massless material things. The famous formula derived by Einstein that relates mass and energy for a system at rest, $E = mc^2$, is just a special case of a more general energy-momentum relation $E^2 = (mc^2)^2 + (cp)^2$. For massless particles such as photons, the energy is $E = cp$, where p is the momentum and c is the speed of light.

I can offer an objection to this second definition provided by Bunge. Although change always requires energy, and then it is correct to say that all material things have energy, it is not true that energy always allows for change. If a complex system is in thermodynamic equilibrium, i.e. if its entropy is at a maximum, then the system will not change. This is because it is not the total energy what matters for change, but the difference of energy between different parts of the system. This difference is quantified by entropy. Bunge’s definition, I think, only applies to simple things, substances, and not to systems. In general, energy does not amount to mutability, which is the true trademark of materiality. Hence I will adopt in what follows the first definition of material thing: any substance, system, or aggregate with a non-trivial state space.

A final remark about these definitions is that they do not involve the concept of time. Change is determined just by motion in the state space. This space can be parametrized in terms of time or other dimensions. Our definition is completely general.

We are now in position to define the concept of *matter*.

Definition 3 Matter (\mathcal{M}) is the set of all material things.

Symbolically,

$$\mathcal{M} \stackrel{\text{def}}{=} \{x : Mx\}. \quad (2.2)$$

Matter, then, is not a substance but a concept: an abstraction from concrete material things. What actually exists are material beings, not matter. Matter, in words of Bunge, is not material. It is conceptual (Bunge 1981).

If matter is not a substance, how many substances are there? The answer is simply as many as basic things. The actual number and nature of these things should be determined by science, not by ontology. This is the ‘Primacy of Physics’ constraint advocated by Ladyman and Ross (2007). Physical research of the elemental

⁴ A non-material being can be said to exist *conceptually*, if it is conveniently introduced by stipulations formulated in some conceptual framework developed by material beings. See below, Sect. 2.9.

constituents of the world would offer provisional answers to this question. I will say more on this towards the end of this paper.

Before formulating the central thesis of materialism, it is convenient to introduce the associated concept of *reality*.

Definition 4 An object⁵ x is *real* if, and only if, (a) there is at least another object y whose states would be different if x were absent, or (b) some parts of x induce changes in some other parts of x .

This is the definition of real object proposed by Bunge (1981). It relies on the idea that whatever is real is something that can be acted upon or can affect other things. We now define *reality* as:

Definition 5 Reality is the set of all real objects.

Again, as it was the case with matter, reality is a concept, and hence it is not real. What is real is the *universe*, i.e. the *system* formed by all real objects. Being a system, the universe, has many emergent properties such as temperature, density, and expansion rate, among others. Reality, instead, do not have properties, although we may assign attributes to the concept in our speech, as when we say: ‘a sad reality’.

We are now ready to state the central thesis of materialism:

Postulate 1 Only material objects are real.

An immediate corollary is that the universe is material.

A consequence of *Postulate 1* is that for materialism changeless objects such as numbers, functions, triangles, God, relations, and fictional characters are not real (see Romero 2018a and my discussion with C. Madrid in this volume for the status of fictions and mathematical objects).

Postulate 1 is shared by all forms of materialism. We need now to introduce some additional qualifications to fully characterize *systemic materialism*. Before moving on, I offer a chart in Fig. 2.1 with a summary of the proposed classification of objects.

2.3 Laws

In the definitions offered in the previous section, change, the ability of a thing to go from one state to another, plays a fundamental role in the characterization of the concept of matter. Change, however, is not arbitrary. Change follows patterns, as already noticed by the first pre-Socratic philosophers (see Chap. 1 of this book). Such regularities can be represented as restrictions upon the state space of real objects. Since we represent the properties by mathematical functions, then the

⁵ An object is anything we can refer to.

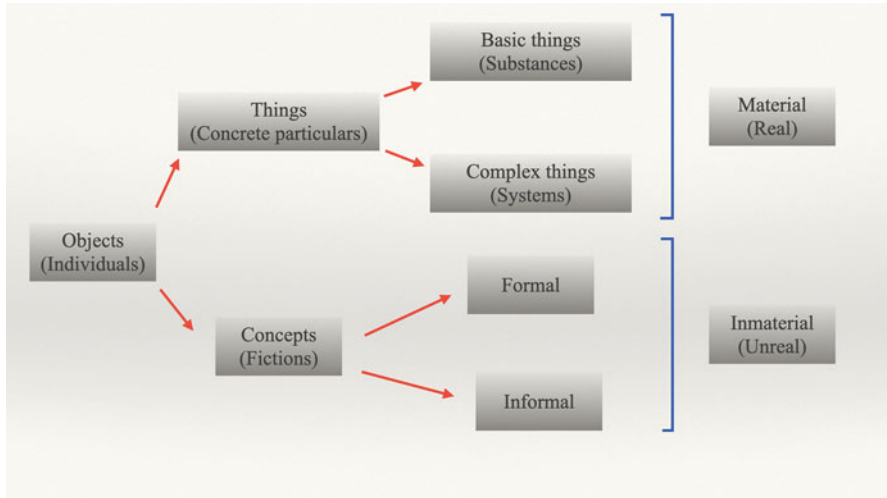

Fig. 2.1 Classification of objects according to systemic materialism. Basic things have fundamental properties. Systems have emergent properties. Concepts have attributes, assigned either formally, i.e. through a formal system, or informally (e.g. through a narrative). See Romero (2018a, Chapter 7) for details

restrictions are usually represented by differential equations (occasionally, integro-differential or algebraic equations can be used). In order to solve an equation and find the trajectory (succession of changes) experienced by a particular thing in a specific situation, we need to characterize that situation through the specification of initial and boundary conditions.

It is important to emphasize the difference between the universal, stable, and objective patterns occurring in the universe, i.e. *the fundamental laws*, and the representation of such laws by equations, i.e. from the *law statements*. This is similar to the distinction between property and predicate. The predicate represents the property in our conceptual network. Law statements represent the natural laws in our theories. A consequence is that law statements, being just conceptualizations, can be tested, corrected, ruled out, or improved. Such modifications are a key ingredient in the dynamics of science (e.g. Bunge 1967b).

In addition to fundamental laws, i.e. the laws followed by basic things or substances, we can introduce *derivative laws*⁶ that follow from the regular behavior of complex things and systems. Most law statements in our theories represent laws of this kind. They are not strictly universal, but stuff-dependent. They apply to some particular kind of things and cannot be expressed using unrestricted logical quantifications. Examples of fundamental laws are the laws of gravitation, basic

⁶ Bunge called them *constitutive laws*, because they depend on the nature or constitution of the system to which they apply.

conservations laws, or the laws of the basic fields of the standard model, whereas examples of derivative laws are laws of elastic bodies, laws of plasma physics, most laws of chemistry, etc.

A third type of law is given by the regular patterns shown by laws themselves. These patterns conform laws of laws or *meta-laws*. These meta-laws are represented by *meta-nomological statements* such as the principle of general covariance or the principle of minimal action (Bunge 1967a).

Finally, Bunge also introduces what he calls *nomo-pragmatic statements* (Bunge 2003b). These are pragmatic statements obtained from one or more laws of the first two types and a specific situation. Examples are law statements for electric circuits and most laws applied in social sciences.

Since all material systems change according to laws, we can refine **Definition 1** to:

Definition 1' Let be x a thing (either basic or complex), y some other thing considered as a reference frame, and $S_y^L(x)$ the *lawful* state space of x with respect to y . Then, x is material if, and only if, $S_y^L(x)$ contains more than one element.

Material things only change lawfully. From **Definition 1'** and **Postulate 1**, it follows trivially:

Theorem *Magical (i.e. unlawful) events are not real.*

What is the origin of the fundamental laws? Why the universe displays regular patterns of change? Traditionally, there are two kinds of attempts at explaining the existence of laws. On the one hand we have the *externalists* conception of laws. According to this view, laws are some kind of entities in the universe existing in addition to material things. If properties are conceived as universals, then laws would be second-order universals that relate them (e.g. Armstrong 1983). Externalists, crudely expressed, think of laws as governing the behavior of things.

On the other hand we have the *internalist* view which tries to explain lawful changes without resorting to anything above the individual things that populate the universe. Perhaps the more popular internalist view considers laws linguistic items adopted to systematize our experience of nature (e.g. Cartwright 1989). Bunge himself never expressed conclusively his position about the topic, to my knowledge at least. But it is clear that an externalist conception of laws is incompatible with the kind of materialism he espoused.

I think that the kind of internalist position that suits better to materialism is one where the laws are understood, as we have already mentioned, as restrictions imposed on the state space of the individual things. But if we adopt such a view, we should also ask what imposes the restrictions? The only possible answer in the context of materialism is that the restrictions are imposed by the material things themselves. To be something necessary implies to be in some way. If something is in some way, i.e. if something has some properties, the very existence of these properties restricts other possibilities of being for other entities.

If we think that properties plus some external conditions are *powers*, i.e. sources of change and action, then it is natural to think that out of all powers in the world

some equilibrium will be achieved.⁷ The patterns that define such equilibrium are what we call fundamental laws. If the properties and conditions were different, different laws would result. Actually, it might be the case that some laws could evolve as the universe develops. Although current observations impose some strong limits to the variation of fundamental constants and laws, there is some room for evolution on very long scales (Uzan 2003). I, then, complement the **Definition 1'** with the following proposal:

Proposal Lawfulness is the result of the mutual equilibrium of all the powers in the universe.

Here, a power is defined as:

Definition 6 A power is an active (i.e. capable of changing) property in a material thing that, under the right environmental conditions, can trigger changes in other things.

2.4 Systems

In the previous sections I have referred to systems, loosely defining them as 'complex things' or 'things formed by substances'. Given the importance of the concept of system for systemic materialism, it is time now to introduce it more properly.

Definition 7 A system is a complex object every part or component of which is related to at least one another component.

If the components are material, the object in question will be a material system. Examples: living organisms, atoms and molecules, books, hospitals, galaxies, the universe. If the components are formal concepts, the system will be conceptual, as a theory.

Given our definitions of systems and real objects, the following theorem is immediate:

Theorem *A system is real if, and only if, it is composed exclusively by real parts.*

This means that conceptual systems such as models and theories, no matter how complicated or exact they may be, are not real: they are fictions. What is real are the creators of such models and theories as well as the media we use to formulate, transmit and teach them, from inscriptions in paper to electronic devices.

Now, we can state the basic specific assumption of *systemic* materialism (Bunge 1981):

Postulate 2 Every material object is either a system or a part of a system.

⁷ For a discussion on powers see Harré (1970).

This postulate implies that there are not completely isolated things. If something is material, it should interact with at least something else. If something is material, another material thing must be able to affect it.

Any system is characterized by its *composition*, *environment*, *structure*, and *mechanism*.

The composition of a system is the collection of its parts. These parts can be other systems, as for instance cells in a living organism, or basic things (substances), as perhaps quarks in a proton.

The environment of the system is the collection of things that interact with the system. Everything, but the universe, is located in some environment. The *boundary* of the system is the collection of parts that are in direct interaction with the environment. Because of the complexity of some systems and their surroundings, boundaries can be very fuzzy at times. Even particles in the intergalactic medium are exposed to interactions with photons from the Cosmic Microwave Background radiation and the effects of the curvature of spacetime and hence they are not completely isolated.

The structure is the collection of relations (bounds or links) among the components of the system, as well as with the environmental objects. The former is the endostructure, the latter the exostructure. The total structure is the union of the two. Only substances lack of structure. If a collection of objects do not interact, if they are not linked somehow, then they do not form a system: they are just a set, and sets are conceptual objects, not material ones.

Finally, the mechanism is the collection of all internal processes that occur in the system. A process is just a lawful succession of changes. Mechanisms are what make the system to behave in the particular way it does. For instance, thermonuclear reactions form part of the complex mechanisms that allow a star to be in approximate equilibrium and emit radiation. Potential discharges caused by concentrations of neurotransmitters are part of the mechanisms that allow neural networks to perform their specific functions.

A *subsystem* is a system such that its composition and structure are part of another system. Example: the neural system is a subsystem of the human body, the Earth is a subsystem of the Solar System, and so on.

The maximal system is the universe, i.e. the system of all subsystems. As I already mentioned, the universe should not be confused with the *set* of all material things. In particular, I remark that there is no maximal set. This is not valid for systems, which admit a system of all systems. The universe has a composition (all real things), it has an empty environment (it is the only system with null environment), it has a structure determined by all the interactions among material systems, and its mechanisms are the totality of processes. Among the emergent properties of the universe as a system we can mention its density, temperature, expansion rate, baryon content, dimensionality, topology, and metric structure.

Nowadays, speculations about multiverses are popular both in the press and in some technical literature. If such universes are thought as non-interacting, then for systemic materialism they are not considered real. There is no way to establish their existence. Instead, if 'other universes' have some kind of manifestation or

interaction with ‘our universe’, then they are not other universes at all but parts of a more complex universe than previously thought.

We can model any given system x by an ordered quadruple in the following way:

$$\mu(x) = \langle C(x), E(x), S(x), M(x) \rangle, \quad (2.3)$$

where the components are sets that represent each one of the four collections that characterize the system.

The system can change because it changes its composition, or because of interactions with the environment. It can change because new internal links are formed or old ones are destroyed or decay, and it also changes because of the manifold processes that occur in it. Every system, except the universe, interact with other systems in some respects and is isolated from other systems in other aspects. The finite speed of the propagation of interactions actually introduces a network of internal constraints to the universe, making impossible for everything to be in interaction with everything else.

Conceptual systems, contrary to material ones, do not change. Their composition is fixed (e.g. the number of axioms in a theory), the environment is just given by other theories within a larger conceptual context, the structure is also fixed given by the internal formal relations, and there are not mechanisms operating because mechanisms are purely material since they require processes. When we talk of the “evolution of a concept”, the “dynamics of a theory”, and the like, we are using figures of speech. What evolves actually is our attitude toward some concepts, theories, etc.

One of the most important implications of systemism is that there are emergent properties, i.e. properties of the system that are not properties of its parts. I will discuss this issue next.

2.5 Emergence

Systems, as substances, must be some way or other, i.e. they have properties. A star, for instance, has temperature, pressure, and luminosity, among many other properties. These properties are called *emergent* because the basic components of the star lack them. Other properties can be present in both the basic components and the systems. Energy, for instance, is one of them. Mass is another. We can define an emergent property as:

Definition 8 Let x be a system with a composition $C(x) = \{y_1, y_2, y_3, \dots, y_n\}$ and let P be a property of x . Then, P is an emergent property if there is no member of $C(x)$ such that it is the case that $P y_i$, ($i = 1, \dots, n$).

Formally,

$$P \text{ is an emerging property} \stackrel{\text{def}}{=} \exists x(y)(Px \wedge y \in C(x) \Rightarrow \neg Py). \quad (2.4)$$

Emergent properties are present everywhere: atoms and molecules form cells, but the former are not alive while cells are. Molecules are not elastic but strings formed by huge numbers of molecules might be elastic. A single atom has not entropy, but an atomic gas has measurable entropy; some animals can walk, although cells and tissues formed by cells cannot, and so on.

Emergence should not be confused with *supervenience*, which is a weaker, although related concept. Supervenience is the dependence of one set of properties on another. It is used, for instance, to state that a given set of mental characteristics are supervenient upon physical or biological properties. Emergence, instead, requires the occurrence of qualitative novelty: systems in general are not similar to their parts (fractal systems are the exception, not the rule). Bounds and interactions among components produce effects that are not present in mere agglomerations of elements. This is because systems, conversely to aggregates, have a structure and mechanisms resulting in new properties and powers (see Mahner and Bunge 1997 for more on the differences between emergence and supervenience).

Emergent properties can be local, as an acute pain in my knee, or global as the overall equilibrium of my body. Scientific research of systems of any kind tries to explain emergent properties and the associated behavior in terms of internal interactions among parts of the system and external influences of the environment. For instance, our knowledge of the internal structure and composition of atoms allows us to understand and explain why some elements are more stable than others.

Things with emergent properties are also emergent, i.e. they do not exist at a more basic ontological level. Molecules or cells are not found in the sub-atomic level of quarks and gluons. Galaxies do not exist at the level of stellar objects, and so on. Emergent things can lose properties with the weakening of their internal bonds and through interactions with the environment. Such process can lead to the disappearance of properties and, finally, to the *extinction* of the emergent thing and its dissolution into the constituent parts or in surviving subsystems. In such a case there is a level reduction and a destruction of complexity. The most dramatic example of this is perhaps the extinction of the mental faculties as the brain deteriorates in humans and other evolved animals.

The emergence and extinction of things is mostly an evolutionary process: a series of changes where some properties are acquired and others are lost. Bunge (2003a) proposes the following postulate:

Postulate 3 The evolutionary process of a thing is always associated with the emergence of some properties and the extinction of others.

I notice that emergence and assembly of new systems can be understood as a decrease in the dimensionality of the state space of the corresponding agglomeration of components. A gas, for instance, has a smaller state space than the myriad of particles from which it emerges. Similarly, extinction involves the recovery of the

state space of the free components: the links are destroyed along with the structure that gives identity to the emergent system.

One important consequence of emergence is the already mentioned formation of *levels* of organization in nature. A level is not a thing or a system, but a collection of them, namely the collection of all things that have certain properties in common. Levels of organization can be defined with respect to a set of properties. The more complex is the composition and the structure of the systems in a given level, the higher is the level in the evolutionary process.

Definition 9 Let $A = \{P_i\}$ be a set of properties that are specific of certain things x . Then, $L_A = \{x : P_i x\}$ is the ontological level formed by things x with respect to the set of properties A .

Postulate 4 The set of all levels forms an ordered structure $\mathcal{L} = \langle \mathcal{L}, < \rangle$, where the relation $<$ is such that for any level L_i , $L_i < L_{i+1} \stackrel{\text{def}}{=} (x)(x \in L_i \Rightarrow C(x) \subset L_i)$, where $C(x)$ is the composition of x .

We also postulate:

Postulate 5 The systems on every level have emerged in the course of some process of assembly of things from lower levels.

Bunge (1979, 2003a) differentiates five great levels of organization: physical, chemical, biological, social, and technical (see also Blitz 1992). Each level is populated by entities with some properties that are specific of that level alone. For instance, chemical stuff undergoes specific reactions and processes not showed by purely physical systems, biological organisms have a number of novel functions not observed in chemical substances, societies and biological populations exhibit very distinctive patterns of behavior, and machines have some properties that are not present in the preceding levels.

All this, of course, is just a tentative classification. Disagreement is possible about some levels, and the issue should be solved by investigation of the way the world is actually organized.

Notice that not all properties are emergent in each level: some properties such as energy, mass, etc., go up through the whole scale and can be found in every level. And also some properties disappear when complexity increases; for instance, societies are not alive, although they are composed in part by living beings.

The composition of things in a given level is formed by items of the previous levels in the hierarchy of systems. Only at the very bottom of the scale we have basic things (substances).⁸ And of course many sub-levels can be proposed to refine our view of the organization of nature and the emergence of complexity. Each sub-level should be specified with respect to a well defined set of properties.

Emergence is of paramount importance to systemic materialism because it avoids the collapse of this kind of materialism to mere physicalism. For the physicalist,

⁸ Someone might disagree with this statement, since future research might indicate other possibilities. I will say something about this in Sect. 2.8.

only the basic substances of fundamental physics have true properties. All the other things we observe in the world, from apples to galaxies, are actually “particular dynamic configurations of substances” (Heil 2012). According to this view, there are not emergent properties because such properties should be properties of emergent substances, and a substance, being mereologically simple, cannot emerge. When we say that an apple is juicy, say, we are attributing a property just by courtesy, a pseudo-property. What we really mean is that there is a complex dynamic arrange of substances and what we call a property of the apple is just the name we give to the effect of the constituent substances upon us. Heil illustrates his point with figures similar to the ones in the left and central drawings of my Fig. 2.2. There, we see an aggregate of substances, x_1 , x_2 , x_3 , and x_4 each one with a specific property P_1 , P_2 , etc. Imagine that such a configuration of substances is what we call an object O . And let us suppose that we want to attribute to this object a new property P (Emergent). The argument goes that there is nothing to attach this property to since it is not a property of the basic substances. And only substances have properties. The conclusion seems to be that there is not, actually, such a new property. The presumed emergent property is just a name for the complex effects of the basic properties that the vast arrangements of substances have.

I think that the flaw with this argument is that it neglects the links and interactions among the basic things that form the object. The object is not a mere aggregate. It is a system and emergent properties are properties of emergent things. Emergent things are not substances, but are formed by them. However, systems cannot be simply reduced to their parts because interactions and internal processes are as important as composition to determine their functions and properties, i.e. their ways of being.

This is illustrated in the right drawing of Fig. 2.2, where I show, symbolically, the internal bonds of the system. The emergent property is a property of the system and the system is more than its parts. The system has qualitative novelty and hence it has its own ways of being: it has emergent properties.

Summing up: substances have basic properties, and composed things have emergent properties. Because emergent things are more than mere aggregates, they have their own ways of being, i.e. we can attach properties to them.

Because of these reasons systemic materialism should not be confused with a form of physicalism. A consistent systemic materialist does not think that everything is reducible to physics. The basic substances of physics (fields, say) may well be the ontological foundation on which the whole building of beings is supported, but as complexity increases, more mechanisms and links are established among parts and the resulting systems acquire new ways of being, i.e. emergent properties, that cannot be found in the purely physical world. Chemical reactions, biological functions such as digestion or vision, intensional behavior, and abstract thinking are not proper of the physical level albeit they are impossible without it. These specific properties (functions) are acquired by material systems through evolutionary processes.

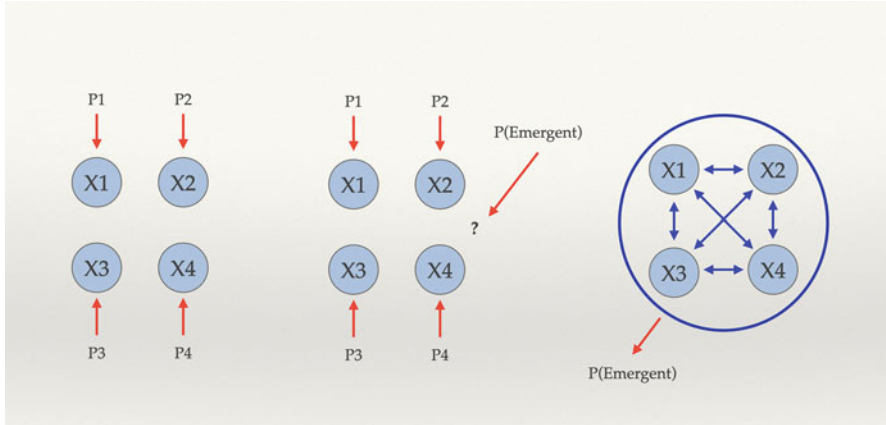

Fig. 2.2 This sketch illustrates the difference between mere aggregates and systems with emergent properties. On the left, we have 4 basic things with 4 properties. In the middle, I illustrate the failed attempt to ascribe a property to the aggregate. Since the latter is nothing else than its components, there is no entity to which we can assign the new property. In the right, I represent not an aggregate but a system, with links among the different components, a structure, and an environment from which it is separated by a boundary. Now the new property can be ascribed to the system

2.6 Mind

Many current discussions on materialism in the philosophical literature revolve around the nature of the mind. Sometimes even materialism is defined negatively as the view that there are not mental substances. In the case of systemic materialism, the mind-body problem is an important one, but hardly the central issue. The view that what we call *mind* is a collection of functions of the brain arises naturally from the ontological framework I have outlined above when it is nurtured with the insights of biology and, in particular, neurosciences (Sellars 1969 [1922], Chapter XIV; Hebb 1949; Smart 1963). Bunge himself has devoted several books to the topic (Bunge 1979, 1980, 2010), some of them in his polemic partisan style. Because of that, and since the issue is discussed at length in other parts of this book, I will limit myself to offering some definitions with the purpose of just framing the problem. These definitions, conversely to those given by Bunge in the mentioned texts, are general enough as to make room for artificial mental activity (artificial intelligence, AI).⁹

Definition 10 A complex material system is *plastic* if, and only if, being part of a larger system, it is able to change its structure with time in response to external stimuli and spontaneous internal activity.

⁹ Bunge notoriously opposed to the possibility of AI, e.g. Bunge (1956, 2010). I do not share his views. This is not the place, however, to discuss the issue.

Science shows that the neuronal systems of some animals (including humans) contain subsystems that are plastic.

Definition 11 A plastic system learns when new and stable internal links are formed as result of activity and interaction with external stimuli.

Postulate 6 Some plastic material systems capable of learning have plastic sub-systems that can monitor, register, and cause some specific activities (functions) performed by the entire system.

The human brain seems to be capable of such activity. Also, the brains of some apes, dolphins, and elephants might be able to perform such tasks.

Definition 12 A *conscious* being is a material being self-aware of its existence, its environments, and some process occurring in it.

Definition 13 A *mental* process is any process occurring in a plastic sub-system of a conscious being.¹⁰

The basic postulate of systemic materialism (and many other forms of materialism as well) regarding the philosophy of the mind is:

Postulate 7 For every mental process M in a conscious being, there is a process N in a plastic material system of the same being, such that $N = M$.

In other words, materialism postulates that all mental processes are actually processes occurring to a certain class of material systems. There are not mental or spiritual substances.

Several corollaries follow trivially. These are a few examples:

Corollary 1 *Mental disorders are disorders of plastic material systems.*

Corollary 2 *Mental activity disappears with the destruction of the plastic material systems where it takes place.*

Corollary 3 *The mind is not an entity. It is a collection of processes and specific functions of a material system.*

2.7 Spacetime

The nature of space and time has always troubled materialistic-oriented philosophers. The early Greeks notoriously differed in their views of space and time. In the Middle Ages the discussion continued along the paths already delineated by Aristotle and Plato. Only after the scientific revolution the discussion started to be informed by physical science, from the Leibniz-Clarke correspondence onwards.

¹⁰ Non-conscious beings with plastic sub-systems can also experience psychic activity, related to perception and other biological functions. Also notice that mental activity in conscious beings can go unaware, i.e. it can be unconscious.

This is not the place to retell the history of the concepts of space and time, a task that has been admirably accomplished by Jammer (1983) and Sorabji (1983). Here it is enough to note that Bunge, as well as Sellars, were strongly influenced by the Leibniz-Machian relationist positions, espoused also by Einstein in his early works.¹¹

In the volume 3 of his *Treatise*, Bunge (1977) presents what he thought was a consistent relational theory of physical space compatible with systemic materialism. He tried to construct space and time *à la* Leibniz from the interactions of material systems. However, his theory only achieved a partial success: space and time remained separated and Euclidean. In 1998, Perez-Bergliaffa, Romero and Vucetich (1998) generalized the approach to recover a pseudo-Euclidean spacetime (Minkowskian). Subsequent efforts to extend the work to encompass pseudo-Riemannian spacetimes failed. Such a series of failures made me to embark into a research of problems associated with the energy content of curved spacetime and issues related to gravitational waves and quantum field theory in curved spacetimes. Such a research convinced me that spacetime is material. Some arguments can be found in Romero (2012, 2013a, 2015, 2017, 2018a, and 2018b).

With the detection of gravitational waves in 2015, Bunge himself started to change his mind about spacetime, and published a short article (Bunge 2018) arguing for the substantial character of spacetime. However, as I showed in a companion paper (Romero 2018b) some of his reasonings were defective, because he still conceived spacetime as a metric field. This led him to some misunderstandings in the interpretation of the problem of a gravitating shell in general relativity.

Here I will summarize some of the arguments for the materiality of spacetime (more arguments can be found in Combi's chapter in this book and in Romero 2018a). The argument presented by Bunge (2018) can be cast in the following terms (Romero 2018b):

- P1. Gravitational waves activate detectors.
- P2. Detectors react only to specific material stimuli.
- P3. Gravitational waves have been experimentally detected.

Hence, gravitational waves are material.

- P01. Gravitational waves are ripples in spacetime.
- P02. Gravitational waves are material (first argument).

Hence, spacetime is material.

The argument is, I think, valid. P1–P3 are well-proven premises from experimental physics. Some confusion, however, can arise because of the somewhat vague form of P01. Gravitational waves actually are perturbations in the *curvature* of

¹¹ Einstein abandoned these views after discussions with de Sitter and Lorentz around 1917. By 1921 Einstein was a convinced realist (what we call today a substantialist) about space and time. His final field program was actually supersubstantialist: he tried to reduce all physics to the dynamics of spacetime; see the discussions in Smeenk (2014) and Kostro (2000).

spacetime. Curvature is represented by the Weyl tensor in the absence of matter fields and by the Riemann tensor in the presence of such fields. These are 4-rank tensors formed by the second derivatives of the metric of spacetime. If we conceive spacetime as represented just by the metric field, it is possible to have null curvature, and hence not energy flux through gravitational waves, but nonetheless the metric might differ from a pure flat Minkowskian metric. This will occur, for instance, when the first derivatives of the metric are different from zero, but the second derivatives are such that the Riemann tensor is identically null over all spacetime.

Spacetime is material because we can define its energy content over a region. This means that if such region is perturbed there will be an energy flux because curvature will change with respect to some dimension and work can be exerted, i.e. spacetime interacts with other material objects. It can act and acted upon. This is what means to be material.

Other arguments for the materiality of spacetime can be based on black hole thermodynamics (Romero 2021). Black holes are regions of spacetime, whose curvature allow the formation of trapped surfaces. Such surfaces act upon the vacuum state of any quantum field producing a polarization that results in the emission of thermal radiation with a blackbody spectrum. This makes possible to assign a temperature to the horizon. Then, purely gravitational perturbations can be used to change that temperature. So the follow argument can be formulated (Romero 2017):

- P1. Only material things can be heated.
- P2. Spacetime can be heated.

Hence, spacetime is material.

Issues related to the dimensionality of spacetime can be applied to argue for eternalism, the view that present, past, and future moments (and hence events) exist. I will not insist about this here, since it is not essential to the materiality of spacetime, and I refer the reader to previous papers (Romero 2012, 2013a, 2015, 2017).

Summing up: modern physics and astrophysics lend support to the view that spacetime is material. An important open problem is whether it is a substance or an emergent system.

2.8 Monism and Matter

In *Scientific Materialism*, p. 26, Bunge (1981) states:

Materialism is a kind of substance monism: it asserts that there is only one kind of substance, namely matter.

This a puzzling assertion, especially if we take into account that just 4 pages before we writes that “*Matter* is (identical with) the set of all material objects.” Then he adds:

Note that this is a set and thus a concept not an entity: it is the collection of all past, present and future entities. (Or, if preferred, M is the extension of the predicate μ , read 'is material'.) Hence if we want to keep within materialism we cannot say that matter exists (except conceptually of course). We shall assume instead that individual material objects, and only they, exist.

Systemic materialism, as it is enunciated by Bunge and also in the reconstruction presented here, admits only the existence of particular objects. Matter is presented as the class of all material *particular* things (Bunge calls them sometimes concrete individuals). And the members of that class are the only ones that exist (see **Postulate 1** above). Among the particulars we have those that are compounds (systems) and those that are simple or basic. The latter are the ones we have identified with 'substances', i.e. entities that are mereologically simple. How many of such substances there are is something that must be decided by empirical research. Bunge (2003b) mentions as examples of basic things electrons, quarks, and photons, and he emphasizes that 'simple' should not be understood in the sense that these entities lack complex behavior. Actually, their properties can be rather complex. Although I agree with the second part of the statement, I think there are some difficulties with the first part: the identification of substances with elementary particles.

The problem is the following: there are myriads of individual electrons, muons, quarks and the other elementary particles identified so far. If we accept that they all are individuals, i.e. different substances, we face the problem of why all electrons have exactly the same intrinsic properties. And the same question applies to every kind of particle. They should be connected in some way if, for example, their electrical charge is identical. Of the infinite possible values of charge, why that exact value, in all cases? This is of course the old ontological problem of the unity of the one and the many, clearly identified and enunciated by Mainländer (1876). If there is not a single universal substance, why we observe such connectedness among things?

I think that the answer to this problem is that the correct ontology suggested by current physics is an ontology of fields, not one of particles (Romero 2018a, Chapter 9; Hobson 2013; see also my chapter on Quantum Matter later on in this same book). Particles are understood in quantum field theory (QFT) as discrete excitations of fields. The ultimate substance is the field not the particle. Particles are one of the ways fields are, i.e. they can be seen as a kind of property of the field. The properties we associate with the particles of a given type come from the underlying symmetries of the field.

There is just one field for each type of particle. This reduces the ontological plurality of many substances to just a few. The basis of the problem of the many does not, however, disappear. The many fields share several properties. Why, for instance, some families of particles are electrically charged, and other families are not? Amazingly, physics points to a possible answer in the same direction as Mainländer did: The conflict can be resolved by introducing the time dimension,

i.e. by considering plurality as an effect of different stages of the development of the universe.¹²

The universe expands so its temperature decreases over time, as does the energy exchanged in physical interactions. The different fields seem to be just an effect of symmetry breaking at low energies, as suggested by the successful electroweak theory that unifies electromagnetic and weak interactions. This is the basis of the standard model of quantum physics, that includes only two types of fields: the quark field and the lepton field.

The similarities between quarks and leptons, for example the fact that they both come in three generations and that they are treated in exactly the same way by the electroweak interactions, strongly point to a common origin. In addition, the fundamental interactions among them share a common description in terms of gauge theories which seem to predict that the strengths of the interactions converge to the same value at very high energies (about 10^{15} GeV). At such energies, quark-lepton fields should interconvert by very massive X bosons. The associated physics would be manifest only when the temperature of the universe was higher than 10^{28} K, about 10^{-35} s after the outset of the cosmic expansion. At that time, the many substances (fields) should have been reduced to one. Since then, progressive decay resulting from the shattering of symmetry caused by the universal cooling produced the current ontological plurality. This image strikingly resembles Mainländer speculations of a single primordial substance, called by him ‘God’, that fragmented yielding the universe.

Very close to the beginning of the cosmic expansion, about 13.8 billion years ago, only two quite different kinds of matter seem to have existed: a grand unified quantum field¹³ and spacetime. Spacetime, as we have seen before, is endowed with energy and interacts with the other fields. Can these two substances be reduced to one or somehow explained away?

Some physicists try to include gravitation, and not spacetime, in a comprehensive field theory. The most popular of these approaches is string theory. After more than 30 years of research, however, such attempts look more and more like a dead end, and many (including me) consider them little more than (quite abstruse) mathematical games . . . and epistemologically problematic (see Baggot 2013; Ellis and Silk 2014; Hossenfelder 2018; Romero 2020; Smolin 2006; Unzicker 2013; Woit 2006 for criticisms of string theory).

Another way to attack the problem is to consider the nature of spacetime itself. Is spacetime really a substance, a basic thing? Or is it emergent from non-spatiotemporal entities? Several lines of research such as loop quantum gravity, emergent gravity, and causal set theory look for a constructive formulation of spacetime from more fundamental stuff. These approaches are background independent

¹² See also the generating substance theory of Anaximandro, who was perhaps the first person to deal with this problem (Chap. 1, Sect. 1.1 of this book).

¹³ I emphasize that at the time being there is not a fully satisfactory, well-established, theory for this grand unification.

treatments in the sense that they require the defining equations of the theory to be independent of the actual shape of the spacetime and the value of the various fields within the spacetime.

But why to think, in the first place, that spacetime might have composition and structure, as other material systems do? A simple argument goes like this (Romero 2017):

P1: Spacetime has entropy.

P2: Only what has a microstructure has entropy.

Then, spacetime has a microstructure.

P1 is a consequence of spacetime having the property of being able to exchange energy. P2 is true of all thermal systems. Then, spacetime seems not to be simple. Other, more technical arguments can be offered in the context of various quantum gravity approaches. The very fact that essential spacetime singularities naturally appear in general relativity suggests that a pure classical picture of spacetime is incomplete (see Romero 2013b for the ontological meaning of spacetime singularities).

Relations among basic timeless and spaceless substances, or ‘ontological atoms’, can be the substratum from where substantial spacetime emerges. I discuss a possible path towards discrete spacetime based on such ontological atoms in Romero (2016). One might speculate that such atoms could give rise not only to the spacetime continuum but also to the matter fields. This is the old supersubstantialist program, envisioned by Einstein and Wheeler, and advocated by some contemporary philosophers as Schaffer (2009). Whether it is possible or not, is something to be established (see Lehmkuhl 2018 for a balanced discussion of the program).

2.9 Knowledge of the Material World

An biological organism is, roughly, a material system such that

1. Its composition includes proteins (both structural and functional, in particular enzymatic) as well as nucleic acids (which make for its reproducibility and the likeness of its offspring).
2. Its environment includes the precursors of all its components (and thus enables the system to self-assemble most, if not all, of its biomolecules).
3. Its structure is such that enables mechanisms that enforce the abilities to metabolize, to self-repair, and to reproduce.

All organisms interact with their environment, and they will survive only if they can recognize things such as food and potential dangers. Organisms with plastic neural networks can map their environment. They will survive if such mapping approximately matches reality. One consequence of such activities is the production of *knowledge* by evolved organisms. Knowledge is neither a thing nor a substance,

but a series of changes in the brain of the knower. The outcome of learning is a collection of brain processes that cannot exist outside the brain.

Definition 14 Let a be an animal endowed with a plastic neural system NS , and consider a time interval Δt . Then, a acquires knowledge of an item F over period Δt if the NS is modified as a consequence of interactions with F .

Knowledge acquisition requires a modification of the neural system¹⁴ of the knower, and such a modification can only be the result of interactions with other material systems. Even if we learn abstract concepts and ideas, the knowledge must be acquired by interactions with books, teachers, visual media, or other material stuff.

There are different kinds of knowledge according to how it is acquired. We can distinguish at least three kinds: sensory-motor knowledge, perceptual knowledge, and conceptual or propositional knowledge, which is the most advanced type.

Notice that I do not define knowledge as true belief, because: (1) One can know false or fictional things, (2) some forms of knowledge are non-propositional (for instance, I can know how to ride a bike or how to swim), and (3) one can know perceptually or by conditioning (e.g. my dog knows when she has to stop and not cross the street without me).

Human beings are also capable of formulating conceptual representations of the world in the form of theories and models (see Romero 2018a, Chapter 4, and Bunge 1983, 2006 for the epistemology of a materialistic-oriented philosophy). Theories are systems of statements, where general concepts and mathematical expressions abound. Theories, however, are too abstract to be compared to reality, so we construct models to represent mechanisms operating in specific things (Bunge 2006; Romero 2018a). In the conceptual construction of any model we use a number of theories and specific assumptions. Models are, then, nurtured with concrete data in order to produce singular statements that can be compared to empirical data (basic statements) obtained by experiment or observation. In this way we obtain some advanced knowledge about the world and acquire the ability to make quantitative predictions.

Such intensive recourse to abstract entities such as concepts, propositions, and mathematical objects seems to be at odds with a materialist view. After all, numbers, linear spaces, matrices, and the like do not seem to change or interact with anything material, so they cannot be material. And hence, according to our materialist **Postulate 1** they should not be real. Nevertheless, we refer to such objects constantly in our scientific representation of the world. How is it possible?

Some materialists adopt an inscriptionalist stance and they identify mathematical objects with the very physical inscriptions we use to denote them (e.g. see the chapter by C. Madrid in this volume). This is a form of nominalism that denies the existence of concepts behind the mere inscriptions we use in mathematics

¹⁴I mention the neural system and not just the brain in order to allow for creatures with decentralized nervous system.

and formal sciences. In one of the discussion chapters below I argue against this position. Mathematics is too rich to be reduced to mere physical objects. Concepts lurk everywhere in our language, not only in mathematics. To relinquish them is to abandon thinking.

I maintain the thesis that mathematical objects and other concepts are *fictions*. They are free creations of human beings, but they do not have autonomous, material existence. We *pretend* they exist, for convenience, but the existence criterion for such fictions is quite different from that used for material systems. We say that fictions exist if they are well defined in a well-formulated system of statements.

To say that mathematical objects and other concepts are fictions does not imply that they should be arbitrary or subjective. They are constrained through rules in formal systems. Their existence, then, is relative to such systems. They are relative albeit objective, because the rules are the same for anyone willing to use the concept. For this reason, mathematical objects, contrary to the more free creations of art, do not leave room for arbitrariness. Although we can imagine a character of a novel doing different things as those stipulated in the novel where he or she was introduced, we cannot think of a mathematical object with attributes different to those stipulated in the formation rules (e.g. we cannot think the number 4 being prime). To differentiate well-formed fictions from loose ones, I use the expression *conceptual artifact* for a fiction rigorously introduced by stipulations within a formal system (see Romero 2018a, Chapter 7 and my discussion with C. Madrid later on in this book).

The thesis that mathematical objects and other well-defined concepts are conceptual artifacts is called *formal fictionalism*. It is a form of conceptualism that is consistent with materialism because conceptual artifacts can only be formulated by material beings such as humans. Mathematics is ontologically neutral: it makes no assertions about the world. Various aspects of fictionalism have been discussed by Vaihinger (1911), Woods (2009[1974]), Bunge (1985, 1997, 2006), Thomasson (1999), Bueno (2009), and Romero (2018a).

Now, an important issue that a coherent materialist should address is, why, if mathematics do not refer to objects existing in the world, can be used in our theories to represent many features of material systems?

The answer, I think, is that precisely because pure mathematics is ontologically neutral, mathematical concepts and structures result portable across various and different research fields. Mathematical concepts, being formal and exact, can be used with profit to represent certain features of real things in the context of our theories. This can be done only if we equip the mathematical apparatus we want to adopt in empirical science with semantical statements that link the abstract structures and the different mathematical objects with factual referents we assume exist in the world. It is not that we apply mathematics to reality, but rather that we can make our ideas about reality more exact through their mathematization.

A same mathematical equation can be used in different fields, provided we change the interpretation. For instance, the continuity equation appears in theories of fluids and in electrodynamics, but obviously some of the functions represent different physical properties in these different theories.

The adoption of an exact language based on mathematics allows the scientists to have a greater expressive power to describe with precision the world, much greater than with a mere natural language. So, mature science resorts to mathematics to formulate its empirical theories.

Not all mathematical theories are useful to formulate ideas about the world, and theories once considered irrelevant for physics might become indispensable when new phenomena need to be understood. A classical example is Riemannian geometry, which had little use in physics before the advent of general relativity. Another example is matrix algebra, which was scarcely known by scientists before quantum mechanics. Sometimes, physicists even need to invent the mathematical formalism they need, as it was the case of Newton and Leibniz.

Most mathematical theories, however, are never adopted in the factual sciences. There is not an a priori way to determine whether a given mathematical theory will be useful or not to represent the material world. This is simply because we do not know in advance how the world is. It is wise, however, to keep our conceptual toolkit as well-supplied as possible, and it is for this reason that mathematical research explores paths that are not, and may will never be, related to anything existing in the world.

2.10 Values in a Material World

Most organisms and some complex machines can evaluate items of their environment and perform actions in accordance with such valuations. For instance, animals can identify some objects as food, and look for them. Some animals value more some kind of food than other, showing a clear preference. In humans, valuation becomes conceptual and some people value not only material objects and processes but also ideas.

Normal animals strive to attain or retain a state of well-being. This state, however, is not the same for all. Hence, normal animals value positively, i.e. they find good, anything they need for their wellness and, in the first place, for their survival. I think, as Bunge (1989), that needs and wants—biological, psychological, or social—are the origin of the valuation process in human beings. However, I disagree with him when he states that values are objective properties of things, states, or processes (Bunge 1989, and 2003b p. 307). Only things can have properties, and among such properties, we never find values, it doesn't matter how carefully we investigate. Bunge states that values are objective relational properties; if they were to exist as ways of substances or systems relate to each other, research should disclose them, as it reveals other relational properties such as the velocity of a system. A very same thing can be valued positively by an individual and despised by another. In general, there is not a well-defined set of transformation rules for values from one individual to another, as there are transformations of the velocity between different reference frames. The existence of such transformations is what indicates that some relational property is objective and exists independently of our thoughts and feelings.

Instead, when we value, we assign worth to objects and processes if we think or feel that they are good to us. And they are good if they meet some need. When we value some thing x , we attribute to it a *fiction* that we call the value of x . This value is not in the thing; rather, it is a disposition formed in our brain. It is a convenient way to express our need of x . There are not values in themselves: *there are valuable things for some organisms in some specific conditions at a given time*. A very same thing might be very valuable to an individual at some time t_1 and then completely indifferent or disgusting to the very same individual at a different time t_2 .

Since it is common that in a society many individuals have similar needs, they tend to value similar things in a similar way, and hence the illusion might come that the values exist by themselves. Education, knowledge, indoctrination, and whatever might affect our brain and body can influence the way we value.

Hence the importance of education and knowledge for learning to value in a way that is in accordance with our goals. Conditioning, manipulation, propaganda, mere ignorance, and social or emotional pressure can take some of us to value positively extremely harmful things. In addition, goals are not universal: they strongly depend on non-basic needs of humans. Such needs can be intellectual, emotional, or a mixture. Similarly, morals do not exist independently of the human beings that codify and decide to follow them. Morals are not given by God, found through research, or received by sudden illumination. Morals are invented, they are social artifacts design to coordinate and guide social behavior. For this reason, morals should be adapted to each society and should evolve with the society.

I develop these views, that we can dub *ethical fictionalism*, in Chapter 5 of *Scientific Philosophy* (Romero 2018a; see also Teixidó 2019 for a comparison with Bunge's views). In what follows, I offer some definitions and postulates taken with some modifications from that book.

Definition 15 An item a of a collection A is valuable in its aspect b for organism c with goal e , in the circumstance d , at time t and in the light of the body of knowledge f if and only if c assigns an ordering relation V to a with respect to other items of A .

Definition 16 A *table of values* is an ordered set of items

$$V = \{A, >\}, \quad (2.5)$$

where ' $>$ ' is a value ordering relation. Being a set, V is conceptual, not material. What is material is any particular code expressing V in some language.

Values in themselves are fictions. Occasionally, the ordering relation can be specified to a function, and then we can explicitly define the value quantitatively for each item of a set. In such a case, values can be represented by mathematical functions of the form:

$$V : A \times B \times \dots N \times U \rightarrow \mathfrak{R}, \quad (2.6)$$

where A is the set of items to be valued, U is a set of units that characterizes some scale of valuation, and the remaining sets are those of whose elements are mentioned in Definition 15.

Since values are created by material beings they have a material origin although they are not material themselves. Nor they are relational properties. They have the same ontological import of mathematical objects and concepts: none. They are conceptual artifacts projected upon things to facilitate the pursuit of our goals. In the same way we use mathematical structures to represent reality, we use values to guide ourselves through it.

Definition 17 An object x is considered *good* for a human being b in circumstance c if x satisfies a need of b .

Definition 18 An object x is considered *bad* for a human being b in circumstance c if x avoids the satisfaction of some need of b .

If we adopt some scale of valuation where 0 corresponds to indifference, and goods to positive real numbers, then evils (i.e. bad things) correspond to negative numbers.

Finally, I define a *moral code*:

Definition 19 A moral code is an ordered system of norms specifying what is right and what is wrong for a group of individuals.

While some moral norms regulate interpersonal activities, others guide the behavior of individuals. Every moral code is (or should be) supplemented with meta-moral (or ethical) norms stating that such and such norms are superior to such and such other norms. Ethical theory should be informed by science if it aims at being effective in testing and improving moral norms.

Mario Bunge stated in several opportunities (e.g. Bunge 2003b, 2016; Romero 2019b) that valuation in aesthetics is completely subjective, and that this has the consequence that there are not testable aesthetic hypothesis, let alone theories. Again, I disagree. In Romero (2018a), Chapter 6, and Romero (2018c) I propose a materialist theory of aesthetics based on the same fictionalist approach here adopted for the theory of moral values. The reader is referred to those texts to complete the views of this section.

2.11 Conclusions

In this chapter I have set myself the task of outlining systemic materialism, an ontological view mainly developed by Roy Wood Sellars and Mario Bunge during the twentieth century. Systemic materialism considers that material individuals are those with changing properties. Such changes are always lawful, so real individuals exist in multiple states that develop according to regular patterns. Contrary to physicalism, systemic materialism emphasizes the importance of qualitative

emergence and novelty resulting from the association of individuals. Complex entities formed by connected individuals, make up systems. Such systems have emergent properties, a structure determined by their internal and external links, and mechanisms operating in them, i.e. lawful series of changes or processes.

Emergence allows the organization of reality in levels of complexity, each level being characterized by a set of resembling properties. Major levels are those associated with physical, chemical, biological, and social properties. More basic or more complex levels have been proposed by some authors.

Systemic materialism denies the existence of a mental level. The mind is equated to a set of functions occurring in very complex material systems, such as the human brain. Also, for systemic materialism abstract entities do not exist by themselves; they are the product of human activity. Mathematical concepts as numbers, functions, and the like are fictions, conceptual artifacts, constrained by strict rules of formation. Values are also fictions, projected by social individuals upon the world and adopted to guide their behavior.

Systemic materialism is a form of scientific ontology in the sense that its theories are, or aspire to be, informed by the best available science. Its worth should be tested by how fruitful it results to help us in understanding the world. Contrarily to dogmatic philosophy, systemic materialism is not immune to scientific progress. I have tried to illustrate this showing how recent advances in physics had forced changes in some materialistic conceptions related to spacetime and the ontology of basic entities. But without doubt more work must be done to update some materialistic conceptions in philosophy of the mind, ethics, and aesthetics (the latter is a territory virtually unexplored so far).

Above all, I hope to have been able to show that systemic materialism is a project under construction, which requires permanent interaction with the special sciences. A project promising enough as to attract the attention of scientists and philosophers alike.

Acknowledgements I am very grateful to the late Mario Bunge for inspiration, guidance, and friendship. I thank O. Teixidó, J. Pérez Jara, and Lino Camprubí for valuable comments on drafts of this chapter. This work was supported by the Argentine agencies CONICET (PIP 2014-00338) and ANPCyT (PICT-2017-2865), as well as by the Spanish Ministerio de Economía y Competitividad (MINECO/FEDER, UE) under grant AYA2016-76012-C3-1-P and PID2019-105510GB-C31.

References

- Armstrong, D.M. 1983. *What Is a Law of Nature?* Cambridge: Cambridge University Press.
- Baggot, J. 2013. *Farewell to Reality: How Modern Physics Has Betrayed the Search for Scientific Truth*. London: Pegasus.
- Beth, E.W. 1964. *The Foundations of Mathematics*. New York: Harper and Row.
- Blitz, D. 1992. *Emergent Evolution: Qualitative Novelty and the Levels of Reality*. New York: Kluwer Academic Publishers.
- Bueno, G. 1972. *Ensayos Materialistas*. Madrid: Taurus.

- Bueno, O. 2009. Mathematical fictionalism. In *New Waves in Philosophy of Mathematics*, eds. O. Bueno and O. Linnebo, pp. 59–79. Basingstoke: Palgrave Macmillan.
- Bunge, M. 1951. What is chance? *Science and Society* 15: 209–231.
- Bunge, M. 1956. Do computers think? *The British Journal for the Philosophy of Science* 7(26): 139–148.
- Bunge, M. 1959. *Causality: The Place of the Causal Principle in Modern Science*. Cambridge: Harvard University Press. [Third Revised Edition, Dover Publications, New York, 1979].
- Bunge, M. 1967a. *Foundations of Physics*. New York: Springer.
- Bunge, M. 1967b. *Scientific Research*, 2 volumes. Berlin: Springer.
- Bunge, M. 1977. *Treatise on Basic Philosophy. Vol. 3: The Furniture of the World*. Dordrecht: Reidel Publishing Company.
- Bunge, M. 1979. *Treatise on Basic Philosophy. Vol. 4: A World of Systems*. Dordrecht: Reidel Publishing Company.
- Bunge, M. 1980. *The Mind-Body Problem*. Oxford: Pergamon Press.
- Bunge, M. 1981. *Scientific Materialism*. Dordrecht: Reidel.
- Bunge, M. 1983. *Treatise on Basic Philosophy. Vol 5: Epistemology and methodology I: Exploring the World*. Dordrecht: Kluwer.
- Bunge, M. 1985. *Treatise on Basic Philosophy. Vol 7: Part I. Philosophy of Science and Technology*. Dordrecht: Kluwer.
- Bunge, M. 1989. *Treatise on Basic Philosophy Vol. 8: Ethics: The Good and the Right*. Dordrecht: Kluwer.
- Bunge, M. 1997. Moderate mathematical fictionalism. In *Philosophy of Mathematics Today*, eds. E. Agazzi and G. Darvas, pp. 51–71. Dordrecht: Kluwer Academic Publishers.
- Bunge, M. 2003a. *Emergence and Convergence*. Toronto: University of Toronto Press.
- Bunge, M. 2003b. *Philosophical Dictionary*. Amherst: Prometheus Books.
- Bunge, M. 2006. *Chasing Reality. Strife over Realism*. Toronto: University of Toronto Press.
- Bunge, M. 2010. *Matter and Mind*. Berlin: Springer.
- Bunge, M. 2016. *Between Two Worlds: Memoirs of a Philosopher-Scientist*. Berlin: Springer.
- Bunge, M. 2018. Gravitational waves and spacetime. *Foundations of Science* 23(2): 405–409.
- Cartwright, N. 1989. *Nature's Capacities and Their Measurement*. Oxford: Clarendon Press.
- Ellis, G., and J. Silk, 2014. Defend the integrity of physics. *Nature* 516: 321–323.
- Harré, R. 1970. Powers. *The British Journal for the Philosophy of Science* 21(1): 81–101.
- Hebb, D.O. 1949. *The Organization of Behavior: A Neuropsychological Theory*. New York: Wiley.
- Heil, J. 2012. *The Universe as We Find It*. Oxford: Oxford University Press.
- Hobson, A. 2013. There are no particles, there are only fields. *American Journal of Physics* 81: 211–223.
- Hossenfelder, S. 2018. *Lost in Math: How Beauty Leads Physics Astray*. London: Basic Books.
- Huerta Martín, F. 2019. Bibliografía de Mario Bunge (1939–2018). In: *El Último Ilustrado*, ed. A. Martino, pp. 215–275. Buenos Aires: EUDEBA.
- Jammer, M. 1983. *Concepts of Space. The History of the Theories of Space in Physics*. 3rd, Enlarged Edition. New York: Dover.
- Kostro, L. 2000. *Einstein and the Ether*. Montreal: Apeiron.
- Ladyman, J., and D. Ross. 2007. *Every Thing Must Go: Metaphysics Naturalized*. Oxford: Oxford University Press.
- Lehmkuhl, D. 2018. The metaphysics of super-substantivalism. *Noûs* 52(1): 24–46.
- Mahner, M., and M. Bunge. 1997. *Foundations of Biophilosophy*. Berlin: Springer.
- Mainländer, P. 1876. *Die Philosophie der Erlösung*. Berlin: Grieben.
- Marquis, J.-P. 2011. Mario Bunge's philosophy of mathematics: An appraisal. *Science & Education* 21(10): 1567–1594.
- Martin, R.M. 1958. *Truth and Denotation*. London: Routledge and Kegan Paul.
- Matthews, M.R. 2019. *Mario Bunge: A Centenary Festschrift*. Cham: Springer.
- Perez Bergliaffa, S.E., Romero, G.E., and H. Vucetich. 1998. Toward an axiomatic pregeometry of space-time. *International Journal of Theoretical Physics* 37: 2281–2298.
- Romero, G.E. 2012. Parmenides reloaded. *Foundations of Science* 17: 291–299.

- Romero, G.E. 2013a. From change to spacetime: An eleatic journey. *Foundations of Science* 18: 139–148
- Romero, G.E. 2013b. Adversus singularitates: The ontology of space-time singularities. *Foundations of Science* 18: 297–306.
- Romero, G.E. 2015. Present time. *Foundations of Science* 20: 135–145.
- Romero G.E. 2016. A formal ontological theory based on timeless events. *Philosophia* 44(2): 607–622
- Romero, G.E. 2017. On the ontology of spacetime: Substantivalism, relationism, eternalism, and emergence. *Foundations of Science* 22: 141–159.
- Romero, G.E. 2018a. *Scientific Philosophy*. Cham: Springer.
- Romero, G.E. 2018b. Mario Bunge on gravitational waves and the existence of spacetime. *Foundations of Science* 23: 405–409.
- Romero, G.E. 2018c. Outline of a theory of scientific aesthetics. *Foundations of Science* 23: 795–807.
- Romero, G.E. 2019a. Physics and Philosophy of Physics in the Work of Mario Bunge. In *Mario Bunge: A Centenary Festschrift*, ed. M.R. Matthews, pp. 289–301. Cham: Springer.
- Romero, G.E. 2019b. El último ilustrado. In *El último Ilustrado*, ed. A. Martino, pp. 107–119. Buenos Aires: EUDEBA.
- Romero, G.E. 2020. *La Naturaleza del Tiempo*. Pamplona: Laetoli
- Romero, G.E. 2021. Black hole philosophy. *Crítica. Revista Hispanoamericana de Filosofía* 53(159): 73–132.
- Schaffer, J. 2009. Spacetime, the only substance. *Philosophical Studies* 145(1): 131–148.
- Sellars, R.W. 1969[1922]. *Evolutionary Naturalism*. New York: Russell & Russell.
- Sellars, R.W. 1970. *Principles of Emergent Realism*. St. Louis: Warren H Green.
- Silberstein, M. 2019. Mario Bunge Publications (All Languages). In *Mario Bunge: A Centenary Festschrift*, ed. M.R. Matthews, pp. 775–807. Cham: Springer.
- Smart, J.C.C. 1963. *Philosophy and Scientific Realism*. New York: The Humanities Press.
- Smeenk, C. 2014. Einstein's role in the creation of relativistic cosmology. In *The Cambridge Companion to Einstein*, eds. Janssen, M., and C. Lehner, pp. 228–269. Cambridge: Cambridge University Press.
- Smolin, L. 2006. *The Trouble with Physics*. New York: Mariner Books.
- Sorabji, R. 1983. *Time, Creation and the Continuum. Theories in Antiquity and the Early Middle Ages*. Chicago: The Chicago University Press.
- Teixidó, O. 2019. Sobre la axiología de Gustavo E. Romero y Mario Bunge. *Scientia in Verba Magazine* 5: 57–67.
- Thomasson, A. 1999. *Fiction and Metaphysics*. Cambridge: Cambridge University.
- Uzicker, A. 2013. *Bankrupting Physics: How Today's Top Scientists are Gambling Away Their Credibility*. New York: Palgrave Macmillan.
- Uzan, J.-P. 2003. The fundamental constants and their variation: observational and theoretical status. *Reviews of Modern Physics* 75(2): 403–455.
- Vaihinger, H. 1911. *Die Philosophie des Als Ob*. Berlin: Verlag von Reuther & Reichard. Published in English as *The Philosophy of 'As If'*, translated by C.K. Ogden, London: Kegan Paul, 1923.
- Wang, P.Y.-Z. 2011. *Reframing the Social*. New York: Routledge.
- Weingartner, P., and G.J.W. Dorn. 1990. *Studies on Mario Bunge's Treatise*. Amsterdam: Rodopi.
- Woit, P. 2006. *Not Even Wrong*. New York: Basic Books.
- Woods, J. 2009 [1974]. *The Logic of Fiction*. London: College Publications.

Chapter 3

Discontinuous Materialism



Javier Pérez-Jara

Abstract This chapter has two main complementary goals. First, it analyzes the main ontological ideas of Gustavo Bueno's discontinuous materialism in contrast with other philosophical systems. Second, it explores some of the main ontological questions and issues still open in this system of thought, while advancing some possible paths of resolution. In order to do this, I follow a double general definition of philosophical materialism. Positively, materialism, in general, names the branch of philosophical worldviews that identify being (i.e. the “ὄντως” of ontology) with matter, understood in its broadest sense as changeability and plurality (*partes extra partes*). Negatively, materialism denies the existence of disembodied living beings and hypostatized ideas. Within this general framework, I then locate the specific ontological characteristic of discontinuous materialism in the rejection of any attempt to hypostatize any element, property, state or relation of reality. Like the Medusa's gaze, hypostasizing metaphysics turns parts of the complex interplay of continuities and discontinuities that constitutes reality into stone. I then conduct a comparison between discontinuous materialism and other philosophies, in particular Mario Bunge's systemic materialism, physicalism, ontotheology, and speculative realism(s). This approach aims at opening new avenues for philosophical research for both metaphysics in general and materialist philosophy in particular.

3.1 Introduction: Discontinuous Materialism in the Big Market of Materialisms

Throughout the following pages, I will present Gustavo Bueno's “discontinuous materialism”, a variety of materialism barely known beyond Spanish and Latin American readers. When talking about presenting a “new” form of philosophical

J. Pérez-Jara (✉)
Beijing Foreign Studies University, Beijing, China
Yale University, New Haven, CT, USA

materialism, a perfectly reasonable objection arises: the philosophical market constituted by materialism already seems saturated by corporeist materialism, physicalist materialism, dialectical materialism, mechanistic materialism, holistic materialism, systemic materialism, eliminative materialism, Australian materialism, transcendental materialism, idealist materialism, speculative materialism, feminist materialism, “new materialisms” . . . And the list goes on. In this saturated market, what is the need for or even interest in presenting a “new” form of philosophical materialism?

I aim to show that discontinuous materialism deserves a place in current debates on materialism.¹ Furthermore, and without falling into a-historical reductionisms, I also contend that the apparently rich plurality of philosophical materialisms can be reduced to a more manageable handful of possible ontologies. In other words, there are not dozens of *totally different* materialist philosophical systems. Against the historicist dogma, different materialist worldviews often share common approaches and perspectives. Thus, through this chapter I also aim at defining the main kind of materialist worldviews, with their convergences and divergences, along with the main criteria for such classification.

Although the first section is rather descriptive of Bueno’s thought, my discussion of discontinuous materialism does not seek to be neutral: my analysis of Bueno’s ontological thought is *philosophical*, meaning that I have not shied away from identifying what I consider this philosophy’s main open problems.

Bueno’s philosophical system spreads throughout several decades in books, articles, conferences, classes and interviews. A historical presentation of Bueno’s main philosophical ideas can help picture their logical interconnections and significance. The “crystallization” of Bueno as a public intellectual with an original philosophical system came relatively late in his life, when Bueno was in his late forties. Delivered to the publishing house in 1968, but published in 1970, *El Papel de la Filosofía en el Conjunto del Saber* became Gustavo Bueno’s first book. The book was a reply to Manuel Sacristán’s book *Sobre el Lugar de la Filosofía en los Estudios Superiores* (1968). An influential Marxist at the time, Sacristán, defended the outdated character of philosophy and therefore the appropriateness of its removal from academic studies as a specialty. Sacristán’s reasoning was in line with nineteenth century radical positivism, accepted in part by leading Marxist movements, starting with Engels in his *Dialectics of Nature* (2012[1883]). According to this view, the modern development of sciences, such as physics, chemistry, biology, sociology and the like, has made philosophy an old-fashioned product. The traditional philosophical questions (“What is the human being?” “How do we know the universe?” “Where do we come from?” and so on) were now much better analyzed and answered by positive sciences.

Against this view of philosophy as a sort of grandmother that should retire, Bueno’s book put forward a full-throated defense of the role of philosophy in

¹ After all, thanks to the sociology of intellectuals, we know that the philosophical coherence of a system stands, on many occasions, at a far remove from explaining its cultural impact or lack thereof (Alexander 2004, 2011, 2016; Baert 2005, 2012).

current societies. Bueno resolved the apparent contradiction between science and philosophy through his theory of “first degree” and “second degree” knowledge (1970). First degree knowledge includes technologies and sciences, as well as economic and political techniques. According to this, philosophy is not an autonomous discipline, but a second degree knowledge that analyzes ideas, in capital letters, such as the ideas of Reality, Existence, Law, Causality, Knowledge, Truth, Freedom and God. Although this conception of philosophy as the analysis and systematization of ideas has undoubtedly Platonic roots, Bueno devised it in opposition to any attempt of hypostatizing ideas. Philosophical ideas (second degree) are always products of complex historical and cultural processes (first degree). The interplay between philosophical ideas and first grade concepts can be seen in a variety of examples. Let’s take a very clear one: from the multiple and specific concepts of time that we find in multiple fields, from daily life, physics, psychology, linguistic, to geology and astrophysics, arises the philosophical idea of Time. Neither one specific science nor the combination of all of them can properly answer the question “what is time in general?”. It belongs to the general field of philosophy. At the same time, only a pseudo-philosophy can analyze “time” in general while ignoring the developments of modern sciences. The same can be said for philosophical ideas such as human nature, causality, structure, reality or universe. Therefore, instead of killing it, Bueno held that the development of modern sciences make philosophy a much richer and deeper form of knowledge.²

According to Bueno, the structural dependence of rigorous philosophy on the sciences was already present in Greek philosophy. It is not a coincidence that among Presocratics there were such important mathematicians. For Bueno, geometry and geometrical astronomy were the first real sciences developed in the Western tradition. Their cultural impact was deep: among other things, they provided a canon of rationality supported on impersonal necessity. The so-called first Greek philosophers used that canon for understanding nature (*φύσις*), in opposition to the anthropomorphism and zoomorphism characteristic of mythological thinking (Bueno 1974, 2007). Philosophy and science, though, needed millennia to be well distinguished theoretically and sociologically (Harrison 2015).

This idea could give the wrong impression that although philosophy *needs* sciences, sciences can exist without philosophy. In *Teoría del Cierre Categorial* (1992–1993) and *What is Science?* (2013b) Bueno further analyzed the relationships between sciences and philosophy. Based on these clarifications, philosophical activity also influences important parts of the scientific bodies. Every science has

² From this point of view, one key criterion to measure the quality of a philosophical system is its capacity to incorporate well established scientific theories and discoveries. Nevertheless, although necessary, the necessity of being scientifically up-to-date is not enough to develop good philosophical theories. The best proof of this are all the good scientists that have had or poor philosophies. The idea of philosophy of a second degree discipline mainly supported on scientific concepts and theories, can be coordinated with Mario Bunge’s and Gustavo E. Romero’s view of “scientific philosophy”, i.e. a philosophy properly informed by updated scientific theories and practices (Bunge 1977, 2003; Romero 2018).

explicit or implicit religious, ideological or philosophical presuppositions. And bad ontological and epistemological presuppositions can lead scientists to important mistakes and dead ends.

Aside from this interplay between practical and scientific concepts and philosophical ideas, another important argument that Bueno put forward in *El Papel de la Filosofía en el Conjunto del Saber* is the necessary systematic character of rigorous philosophy.³ Although philosophical ideas would disappear without human beings, they have objective connections “beyond our will”. Thus, for instance, the idea of freedom is connected to the ideas of causality, possibility and necessity. These objective connections between philosophical ideas form systems. In turn, every philosophical system constitutes what Bueno called a “symploké of ideas”. Bueno took the idea or principle of *symploké* from Plato’s *Sophist* (251e–259e), according to which “nothing is isolated from everything else, but not everything is connected to everything else; otherwise, nothing could be known.”⁴ Bueno considered the *symploké* principle as one of the most important philosophical ideas ever developed, under which both radical holism and individualism are wrong.⁵ For Bueno, although it is a necessary attribute, divisibility (traditionally, “partes extra partes”) is not enough to characterize matter; it is also necessary to emphasize *symploké* as a structural dimension of any material reality. For this reason, and although philosophical materialism has usually been linked to metaphysical monism, Bueno underlined that his philosophical system was *ontologically pluralist*.

Each philosophical system represents a *mapamundi* of “dialectical nature”, i.e. confronted with another alternative *mapamundi*. Bueno liked to publicly repeat this motto: *to think is to think against someone else*. Although Bueno was neither a relativist nor a nihilist philosopher, he did not believe that a philosophical *mapamundi* can be a “mirror of nature”, to use Rorty’s formula (1981). Due to our animal limitations, the project of a philosophical system that perfectly “reflects” absolute reality is a utopian project. Against both absolutism and radical skepticism, Bueno explored a third way. Although we are unable to “compare” a philosophical system with absolute reality, we can (and we must) compare different philosophical systems with each other. Bueno’s main criterion for stating the partial truth of a philosophical system was heavily inspired by Aristotle’s *apagogic* argument: having identified the main possible answers for a given philosophical problem, we can say that the (at least) partial true answer is the one that remains after critically discarding the alternatives. This *philosophical discard* can be done only when we

³ In *El papel de la Filosofía en el Conjunto del Saber* Bueno identifies rigorous and systematic philosophy with “academic philosophy”, in contrast with “mundane philosophy”. It is important to note, though, that for Bueno academic philosophy is not necessarily done at universities. Some of modernity’s most important philosophers were not even university professors (Bueno 1970).

⁴ Bueno (1993), pp. xii, xiii.

⁵ As a non-continuist materialism, Bunge’s philosophy also approaches the principle of *symploké* in formulations such as “every one of [the world’s] component things interacts with some other things” (Bunge 2006: 21). For a more detailed analysis of Bunge’s powerful critiques of metaphysical continuism, see my discussion with Íñigo Ongay in this volume.

can demonstrate that the discarded options lead to contradictions and dead ends. When this is not possible, Bueno argued, we should remain in skepticism, at least until future analysis can shed some light on the problem. The work of a true philosopher, therefore, could be compared with the one of a metascientific detective.

3.2 The Ontological Backbone of Discontinuous Materialism

From the early 1970s onward, Bueno labeled his philosophical system *materialismo filosófico*.⁶ Since “materialism” in general is a tree with many branches, this decision has been the subject of much controversy. After all, Bueno’s philosophy had clear differences with other forms of materialism. Many of these differences come up from the very idea of *matter*. By definition, any materialist ontology identifies *being* (i.e. the “ὄντος” of “ontology”) with *matter*. Therefore, every materialist philosophy agrees with the general assumption that everything existent outside human imagination is *material*. The problem, of course, is that the meaning of matter is not obvious at all. Throughout the centuries, “matter” has been an ontological idea linked to scientific developments. The first problem that arises is that sciences often change their theories and hypotheses, sometimes in key aspects; the second problem is that the same scientific theory is frequently interpreted very differently by opposing ontological and epistemological frameworks.⁷

The late Bueno, in his long essay “El puesto del Ego trascendental en el materialismo filosófico” (2009), later extended in his final book *El Ego Trascendental* (2016), identified his *materialismo filosófico* with *materialismo discontinuista*, which I have translated as *discontinuous materialism* elsewhere (Pérez-Jara 2016). Starting with this conceptual identification, I “project” the syntagma “discontinuous materialism” to Bueno’s general philosophical career. The reason is clear: by so doing, I avoid monopolizing “philosophical materialism” by Bueno’s specific version of it.

This leads me to another important conceptual “translation”. Bueno stated, from *El Papel de la Filosofía en el Conjunto del Saber* onwards, that no material entity, structure or process can be considered as an absolute substance. Since partial continuities and discontinuities structure every material reality, Bueno’s philosophical materialism opposes any attempt of hypostatizing any real element, property, relation or event. Bueno identified hypostatizing rationality with

⁶ Specifically with the publication of the seminal *Ensayos Materialistas* (1972), where Bueno summarized the main ideas of his ontology.

⁷ A couple of brief examples will shed some light on this conceptual labyrinth: Hobbes’ and D’Holbach’s corporeal materialism were unaware of electromagnetic waves or nuclear forces, which were considered material later. Their idea of matter, like the more advanced idea of matter in nineteenth century physicalist materialism, is outdated today. Today we no longer identify matter with mass, impenetrability or energy. This means that if the idea of matter is not univocal, there are many materialist ontologies, depending on the idea of matter they rest on.

“metaphysics” in contrast with mythological thinking (which mainly relies on anthropomorphic and zoomorphic analogies). From this perspective, reductionist materialisms are, in Bueno’s terminology, “metaphysical materialisms”. While the rejection of metaphysics was common in the twentieth century, in the last decades “metaphysics” has regained a positive meaning. For that reason, and in order to avoid misunderstandings, I will consider reductionist materialisms as “hypostatizing materialisms”. Therefore, in this chapter I will avoid using “metaphysics” in any pejorative sense.

Throughout thousands of pages, Bueno wrote about all manner of philosophical issues; anthropological, ethical, political, religious, epistemological, gnoseological and so on. Where to begin, then, to present his philosophy’s key ideas? I start from a very conservative but, I think, well-founded assumption: the different branches of philosophy are ultimately supported on ontology or metaphysics. In Bunge’s words, a philosophy without ontology is “spineless”.⁸ Let’s take, for instance, famous philosophical issues related to human nature, such as the following: Is human nature only spiritual, only material, or a combination of both realities? Is free will a *factum* or an illusion? Is there one predetermined meaning of life, many, or none? Do ethical, moral and political principles have an objective reality, or only a conventional-arbitrary nature? According to the objective interdependence of philosophical ideas, these issues always end up referring to ontological issues related to the debates between materialism and spiritualism, fatalism, determinism and indeterminism, idealism and realism, theism and atheism, and so on. Therefore, the impossibility of summarizing the main ideas of discontinuous materialism in a book chapter becomes the difficulty of summarizing its main ontological ideas.⁹

3.3 The Difficulty of Choosing Discontinuous Materialism’s Most Important Ontological Ideas

Discontinuous materialism’s range of ontological analysis is very wide: modal ontology, theory of relations, mereology, system and complexity theory, and a long et cetera. Once agreed upon choosing ontological theses to summarize the main structure of this philosophy, which ones should we choose and why? I think that there are two main ways of dealing with this problem: (1) one is to follow Bueno’s own classification of his philosophical system’s main ontological ideas and (2) is to use an “external criteria” to classify such main ontological ideas. I will combine both approaches. Furthermore, when required by the situation, and as I have already done with “metaphysics”, I will translate Bueno’s most obscure terminology to terms or

⁸ Bunge (2009), p. 18; 2010, p. xi.

⁹ When possible, I will put forward examples about how other philosophical theses of this philosophy rest on ontological considerations.

syntagmas more understandable to an English-reading audience while trying to not lose any connotation implied by the original term in the process.

Bueno often used logical symbols to refer to his ontology's core. According to this (1972, 2016), the most important ideas of discontinuous materialism are three-fold: the idea of World or Anthropic Universe (M_i), the idea of Transcendental Ego (E), and the idea of ontological-general Matter (M). Since two of these ideas (the ideas of "E" and " M_i ") can be *unrolled* into another three (M_1, M_2, M_3), the core ideas of discontinuous materialism (M, E, M_i) can unfold into six: $\langle M, M_i, (M_1, M_2, M_3), E \rangle$.

Bueno's philosophical system reinterprets Christian Wolff's traditional distinction between general and special metaphysics. For Bueno, special ontology deals with the contents of the anthropic universe or World (M_i). Since Bueno held that the World is constituted by three genera, fields or dimensions of materiality (M_1, M_2, M_3), special ontology deals with the analysis of these genera,¹⁰ and its main theoretical enemy, as stated in *Ensayos Materialistas*, is any attempt to hypostatize any of them. In Bueno's terminology, general ontology deals with the relationships between the ideas of M, M_i and E. Special ontology is the philosophical field through which general ontology can be constituted. In turn, E is the "link" between special ontology and general ontology.¹¹ In what follows I will try to clarify this seemingly cryptic soup of letters in a more understandable way.

3.4 The Ideas of World/Anthropic Universe (M_i) and the Three Genera of Materiality

For Bueno, the starting point of every philosophical system is always the *mundus adspectabilis* (Bueno 2004a).¹² As early as *Ensayos Materialistas*, Bueno attempted to put forward a materialist and atheist version of traditional ontotheology's

¹⁰ Bueno (1972), p. 48.

¹¹ Although I will focus later on some specific problems of discontinuous materialism's ontology, it is important to start noting that the terms "general ontology" and "special ontology" themselves are not problem-free. We have seen that, although this terminological division comes from Wolff, it actually has little to do with his metaphysics, in which the idea of Being behaves like the idea of fruit in relation to oranges, apples and grapes. In Wolff's system, special ontology studies the World, Man and God, whereas in Bueno's materialism, special ontology studies the three genera of materiality that compose the World. Although Bueno (1972) put forward some partial analogies between ontotheology's three main ideas and the three genera of materiality, the issue here seems clear: is it the best terminological decision to use "special ontology" to talk about the contents of the World? After all, the distinction between special and general applied to the universe is instantly linked to Einstein's theory of relativity. In it, general relativity studies the universe, whereas special relativity studies limited or partial sectors of it. In order to avoid the more than probable confusions linked to Wolff's and Einstein's use of "general" and "special" in their theories, new terminological possibilities could be explored.

¹² Even if some philosophies do not recognize it, as it is the case of Malebranche's ontologism.

framework to account for the path from the World to its metaphysical source(s).¹³ Through the philosophical analysis of the World, ontotheological philosophies return to the *Deus absconditus* (which believers alone identify with the *Deus revelatus* of faith). Therefore, for them, although God ontologically precedes the World, epistemologically, the knowledge of the World precedes the knowledge of God. Accordingly, the ideas of World/Anthropic Universe (M_i), Transcendental Ego (E) and ontological-general Matter (M) can be seen as a materialist version of traditional metaphysics's ideas of World, Man and God.¹⁴ We could use the analogy of a wheel that can be turned ontologically, from ontological-general Matter (M) to the World (M_i), or epistemologically, from the World (M_i) to ontological-general Matter (M).

Another important philosophical influence of Bueno's ontology is Kantian and post-Kantian philosophy, including phenomenology. Thus, for discontinuous materialism, the World we live in is not the "absolute universe" postulated by naive realism. But it is not an illusion either; it is undoubtedly *real*, but many of its characteristics would fade away if animals and, above all, humans disappeared. If we understand by "real" what exists ontologically and what is epistemologically subject-independent, we would fall into the understanding that, for Bueno, the World is real ontologically, but many of its properties are not real epistemologically, as they "depend" on the subject. In order to overcome an idealist reading of his philosophy, Bueno held that the World is an "anthropic" or "zoothropic" reality, an objective reality given to the human or animal scales.¹⁵ Every animal scale through which the World unfolds has points of intersection with at least some other animal scale. For that reason, Bueno spoke of the "unicity of the World", instead of different isolated worlds (1993).¹⁶

In order to better clarify this thesis, Bueno often used the Neo-Kantian metaphor of the "filter" (2016). According to it, the World's contents are laid out on humans'

¹³ Bueno used the term "ontotheology" in Heidegger's and not in Kant's sense (for whom "ontotheology" was linked to "cosmotheology"). Basically, for Heidegger ontotheology is the worldview according to which "being" is reified into a Supreme Being that has created and controls the rest of beings. In Scholastic terms: for ontotheology, Being, as *Ipssum Esse*, is both the metaphysical God of natural theology and the mythopoetic God of "Revelation". Although Heidegger opposed his thinking on being to ontotheology, Bueno thought that the idea of "being" was too loaded with ontotheological meanings. It seems quite reasonable to suppose that behind this view was Bueno's education in a Catholic Spain where the vast majority of university professors were ontotheologians.

¹⁴ Bueno (2016b), p. 2.

¹⁵ The use of "anthropic" here is not related to the so-called "strong anthropic principle" in cosmology which, due to its metaphysical teleologism, is incompatible with a materialist philosophy. On the contrary, it is a materialist reconstruction of Protagoras' principle whereby "man is the measure of all things" (Bueno 1993, 2016).

¹⁶ Nevertheless, in this chapter I will sometimes use "worlds" between quotation marks as a synonym of human/animals' scales. The quotation marks are placed against any attempt to hypostatize any of these scales. Spiders' "world", such as cats' "world" or the Ancient Sumerians' "world", belong to a common World or universe.

perceptual, operating and sociocultural scales. This implies that the World is the product of applying an “anthropic filter” to some processes of an unknown material reality. Late Bueno identified this filtered reality with the “anthropic universe”. From our ancestors’ mythological constructions to many current worldviews, many are unaware of the existence and importance of this filter. Others, on the other hand, disproportionately exaggerated this filter’s influence, falling into some form of idealism. This distinction between an absolute reality and a reality given/filtered to the human/animal scale, along with the ontological structures and processes behind such division, is the core of Bueno’s ontology.

According to discontinuous materialism, the World’s main ontological dimensions can be classified as *material* mainly due to their plurality, codetermination and symploké. By conceptualizing matter with such general properties, Bueno aimed at rejecting physicalism’s reductionist idea of matter (also shared by idealism and spiritualism: see Bueno 2019). Furthermore, these ontological attributes preclude hypostatizing any of these three ontological dimensions, which Bueno classified as follows:

M_1 : *Physical matter*. From quarks, leptons or electromagnetic waves to cells, stones, mountains and globular clusters. M_1 can be divided into two main categories: (a) *phenomenological*, which is constituted by the “organoleptic world” (mountains, trees, rocks, visible stars, etc.) and (b) *non-phenomenological* (from electromagnetic waves outside the visible spectrum, to nuclear forces and the core of the Earth itself).¹⁷

M_2 : *Psychic matter*. From perceptions, memories, and kinesthetic experiences to abstract thoughts and reasoning. M_2 can be divided into: (a) The psychological contents of my own subjectivity and (b) the psychological contents of the subjectivity of other humans and animals.

M_3 : *Eidetic-abstract matter*. From religious archetypes, the grammatical structure of languages, the conceptual artifacts of mathematics and symbolic logic to scientific concepts and philosophical ideas. M_3 can be divided into: (a) those contents that have already been formulated as such and (b) those contents that have not been formulated as such, but may be.

Special ontology is the philosophical discipline that studies the contents and interplay between these genera, fields or dimensions of materiality. For instance, it starts by emphasizing the existence of “mixed” entities that participate of several of these ontological dimensions at the same time, although not necessary in the same proportion or in a symmetrical way. A good example of this are animals, since they

¹⁷ From my point of view, the main philosophical problem that arises here is this: due to the ontological discontinuities between biological matter, chemical matter and physical matter (all of them belonging to M_1), shouldn’t Bueno’s decision of calling spatio-temporal matter (M_1) “physical matter” be considered misleading? Although Bueno himself (1997) emphasized the discontinuities between organic and inorganic matter, the early decision to call M_1 “physical matter” remained until the end of Bueno’s intellectual career (2016). Bueno’s terminology to refer to M_1 implies a reductionism incompatible with his own philosophy.

are organisms (M_1) with a psyche (M_2), and, in the case of superior animals like humans, abstract artifacts (M_3). Another distorting aspect of special ontology is to give psychological contents (M_2) a similar symbol as M_1 (Bueno 2016a). This is because, as far as we know, the psyche can only be found in a tiny and minuscule part of the universe; specifically in some parts of the biosphere. But, even if exobiospheres did exist, what are they in comparison to the rest of the vast universe?¹⁸

Late Bueno preferred to characterize the World's contents as *stroma* (from Greek στρώμα). Previously, Bueno had used this metaphor in places such as *Teoría del Cierre Categorical*, comparing the World with a giant stroma. But late Bueno preferred to use this metaphor for the specific contents of the World, rather than for the World itself. Through the metaphor of the pieces or fragments of the “layers” or “tapestries” that compose the universe, Bueno sought to move away from both idealism and traditional metaphysical substantialism.¹⁹ Against the latter, Bueno also advocated an “actualist” or “dynamic” substantialism, whereby the “substance” of a thing is not something *beyond* its changing “accidents” or properties, but the temporary invariant of transformations of such accidents (2007). Therefore, traditional substantialism is the product of hypostatizing such temporary and dynamic invariants. Through this actualist ontology, Bueno defended a middle ground between Buddha's and Hume's “bundle theory” and traditional metaphysical substantialism.²⁰

It is important to note that Bueno's theory of stroma opens the problems related to ontological divisions between entities, properties, states, events, and processes. For instance, should M_2 's contents, such as memories and reasoning, be considered as entities, as Bueno held,²¹ or as properties or states of entities, as other thinkers hold?. In any case, for Bueno, the classification of the World's stromas or entities into three genera of materiality is an empirical fact. Space and time are a key criteria

¹⁸ An important issue here is related to the universe's ontological unity. For modern astrophysics, the universe's unity, as a result of a mega-physical aggregate of cosmic materialities, has objective properties (such as a specific topology, average temperature and density, age, and so on). But by identifying the animal and human World with the universe, Bueno held that, without corporeal subjects, we have no criterion whatsoever to talk about the existence and unity of the universe. Nevertheless, the fact that the universe's contents are given/translated/selected/filtered/adjusted at our finite and imperfect human scale should not necessarily imply that these contents do not form a structural unity independent from the epistemological and operational frameworks of humans. Why should we accept Bueno's claim that the anthropic scale has the monopoly on the universe's unity? Are not ontological unities independent from subjects' operations possible?

¹⁹ Bueno (2016), p. 29. The idea of stroma implies, among other things, that cosmic materialities have an “obverse and reverse”, which Bueno translated to a dimension filtered to our human scale, and an absolute dimension (the “reverse”) that is not exhausted on our scale.

²⁰ Nevertheless, I also think that discontinuous materialism's ontological actualism arises key philosophical problems related to the ontology of spacetime. According to current physics, there is not universal simultaneity, meaning that what is an *actual* moment in one part of the universe has already occurred in another. Up to what point, then, does the rejection of the idea of absolute simultaneity affect ontological actualism? And how can we take ontological possibility and contingency into account from radical actualism?

²¹ Bueno (1972), pp. 291–325; (1993), pp. 1420–1427; (2016), p. 196.

to demarcate these dimensions of materiality (Bueno 1972, 1993). Thus, Bueno holds (in all likelihood inspired by Husserl) that the materialities given in M_1 are both temporal and spatial; the materialities given in M_2 are temporal, but not spatial; finally, the materialities given in M_3 are neither temporal nor spatial (but not because they exist in a Platonic heaven, but because time and space have been segregated or offset from the abstract constructions that constitute M_3).²² Of course, there are multiple contents of the World that are composed of realities from different genera of materiality.

3.5 The Idea of Transcendental Ego (E)

The second letter of discontinuous materialism's *mapamundi* is the idea of E, which represents the "Transcendental Ego" or "Transcendental Consciousness". This is, by far, the most misunderstood idea in Bueno's ontology. A significant part of these confusions come from some persistent misreadings of Bueno's philosophy (Bueno 2016a; Pérez-Jara 2008, 2014). Despite this, I also think that Bueno himself is not free from blame. The presentation of the idea of "Transcendental Ego" in *Ensayos Materialistas* is short, obscure and full of ambiguities and unanswered problems. Bueno holds that the idea of ontological-general Matter (which replaces the traditional idea of Being in his philosophy) must be linked to the epistemological scheme of its construction.²³ In a materialist ontology, this epistemological scheme cannot be a reified substance outside the World; it *must* belong to the World.²⁴ Bueno identifies such epistemological scheme with the Transcendental Ego. And, from the onset, he linked this idea to Kant's *Critique of Pure Reason*.²⁵ This, of course, sounds paradoxical, since Kant is the father of the so-called "transcendental idealism", and Bueno is defending a *materialist* philosophy.²⁶ Bueno translates

²² Without denying the pedagogical importance of this criterion of demarcation, it also opens up its own knot of problems. For instance: where does space and time's ontological privilege come from? Up to what point is it ontologically consistent with modern physics "to break" the structural unity of spacetime claiming that psychological activities, although temporal, are not spatial, or that time emerges from animal interactions in space (Bueno 2013a)? On the other hand, if every content we find in the World either belongs to M_1 , M_2 or M_3 (or results from the combination of realities belonging to different genera, such as animals) to which genera or specific combination of genera does space-time belong?

²³ Bueno (1972), p. 65.

²⁴ Which Bueno expressed as follows: $E \subset M_1$.

²⁵ Bueno (1972), p. 51.

²⁶ The problem opened by this use of Kantian terminology is obvious: in Kant's philosophy, the Transcendental Consciousness, in a similar way as Descartes' ego cogito, is an aprioristic disembodied activity or entity. As such, it is not compatible with a materialist ontology: Kant's aprioristic metaphysical Ego is the condition of possibility of the world of matter, from the laws of physics to the brain's activity. For a materialist ontology, on the other hand, there is no possible ego without very complex physical, neurobiological and sociocultural material processes.

Kant's idealism into his own ontology in this way: the Transcendental Ego is not a spiritual a priori principle; rather, it should be considered as the historical and sociocultural process through which the World becomes an object for itself.²⁷ As such, E is an activity essentially linked to ordinary humans made of flesh and blood, and without them, it would disappear. For Bueno, this activity is what structures the very unity of the World as an anthropic reality.²⁸

In late works, Bueno directly confronted the theological and idealist nuances of the idea of Transcendental Ego and the confusions it had led to (2009, 2016). Rather than an absolute architect of the World, Bueno clarified, the Transcendental Ego is the metaphorical architect of every philosophical, mythological and ideological *mapamundi*. In this view, theological and idealist "transcendental egos" would be to differing degrees the imaginary product of reifying the "real" and "materialist" Transcendental Ego.

Against any form of radical idealism, Bueno made it clear that the entities and processes to be found in the World are not exhausted by the anthropic scale in which we interact with them. Every cosmic entity always has an ontological "surplus" that our human (and therefore finite and mortal) scale, cannot exhaust. That surplus relates to ontological-general Matter. The structural contingency and finitude of both the *filtering* reality (the Transcendental Ego) and the *filtered* reality (the World) led Bueno to a key ontological conclusion of discontinuous materialism: the World is neither created nor eternal, but a finite and contingent episode of ontological-general Matter (Bueno 1992, 1993).

From my point of view, though, a non-trivial problem that arises here is linked to the ontological mechanisms that enable the epistemological processes of "zootropic" and "anthropic adjustment" through which some unknown contents of absolute reality become contents of our World are pre- or proto-egological. In truth, they are the conditions of possibility for the formation of the ego itself. Once the ego is constituted through complex biological, psychological, social, linguistic and political processes, egological categories will be key in constituting the anthropic World (2016). But the ontological fact that what starts the process of "separation" between absolute reality and an animal (and later human) World is prior to any kind of ego should cause us to reconsider the pertinence of continuing to call it

²⁷ Bueno (1972), p. 65.

²⁸ Bueno again links this to Kant's philosophy, here to the idea of "transcendental apperception", which is also behind the "partial identification" between the World and the Transcendental Ego (1972: 67). In Kant's philosophical system, this apperception is what makes experience possible at all. Without it, the perceptual data would not be combined or held together in a structured unity. Therefore, it would be an absolute chaos, and knowledge would be impossible. As such, Kant's transcendental apperception is where the ego and the World come together. By this confusing assimilation, Bueno tried to argue that he was not introducing any radical new ideas in philosophy: he was just further deepening age-old philosophical theories. Bueno's Transcendental Ego, as a materialist activity, operates through diverse categories: grammatical, legal, psychological, ethnological, ethological, neurobiological. Overflowing each one of these categories and, at the limit, all of them, this activity is considered "transcendental" by Bueno in a Scholastic sense, rather than in a Kantian/aprioristic one (2009, 2016).

“Transcendental Ego”. Such “Ego” should only be considered as the last stage of a set of still-unnamed processes, a stage that is not even achieved in the vast majority of animal species.

3.6 The Idea of Ontological-General Matter (M)

In discontinuous materialism, the notion of M is a limit idea that designs the most general ontological context that we can conceive of. As such, it includes everything real and possible. Such conceptual privilege places the idea of ontological-general Matter as an atheist replacement of metaphysics’s traditional idea of Being.²⁹ Against Wolff’s idea of Being or Engels’ idea of matter, ontological-general Matter is not just an abstract concept devised to conceptualize the most general ontological properties of the entities we find in the World; it is not like the concept of fruit in respect to cherries, pears and apples.³⁰ Since the World in discontinuous materialism is conceptualized as a finite and contingent set of realities dependent on animal and human filters, ontological-general Matter has the conceptual privilege of referring to those realities that exceed the animal and human scale on which the World unfolds. This infinite, mostly unknown reality is designed as material fundamentally for its plurality, co-determination and mutability.³¹ It can also be considered absolute, *absolutus* (freed, unrestricted) from animal and human consciousness. Therefore, I will identify ontological-general Matter (M) with “absolute reality”.³² The difference between absolute reality and the animal and human World can only be understood by the idea of Transcendental Ego.

Because our positive knowledge primarily comes from the World given at our scale(s), the idea of ontological-general Matter (M) is mainly negative. This explains why Bueno thought that we can only know a few “properties” of absolute reality (plurality, co-determination, sympleké and changeability). Nevertheless, it is important to note that the negative knowledge that we have (or can have) about absolute reality is not the negation of knowledge.³³ As such, Bueno (1993) often associated absolute reality with an “atheist version” of traditional negative theology’s *Deus*

²⁹ Bueno was always reluctant to use the idea of Being because this idea, he claimed, was too linked to monist continuism, from Parmenides’ metaphysics to millennia of ontotheological thought (Bueno 2016a).

³⁰ Bueno (1972), pp. 50, 52, 60, 72, 283, 288.

³¹ For Bueno, these general properties are not the product of imagination, but of apagogic thinking: since M refers to everything that exists or can exist, it cannot be “finite” by definition; since our World is seen as an episode of M, and the World’s discontinuities and changeability are structural, we have no reasons whatsoever to hold that M is an absolute immutable continuous unity; since the idea of absolute auto-determination leads to the idea of *causa sui*, which is contradictory, we should hold that the components of every material multiplicity co-determine each other.

³² The idea of M also has other “secondary meanings” (Bueno 1972; Pérez-Jara 2016), but here, and in order to avoid confusions, I will limit myself to its primary meaning of “absolute reality”.

³³ Bueno (1972), p. 60.

Absconditus.³⁴ Bueno also made a correspondence (not an *identification*) between the idea of ontological-general Matter and traditional metaphysical ideas, such as Anaximander's *apeiron*, Anaxagoras's *migma*, Aristotle's *prime matter*, negative theology's *Deus Absconditus*, Spinoza's *natura naturans*, Kant's "thing in itself", Schopenhauer's *Will*, and Spencer's *incognoscible*.

3.7 The Ontological Problems of Physicalism (or the Hypostatization of M_1)

Physicalism states that everything existent is of physical nature (or at least that everything existent is *reducible* to physical properties). This reduction can have an ontological and epistemological side. Until the discovery of electromagnetic and other non-corporeal physical fields, philosophical materialism was a synonym of "corporeism", made famous in modernity by thinkers such as D'Holbach, La Mettrie, Hobbes, and Gassendi. This corporeism can be tracked down to some of the Presocratic philosophers.³⁵ Indeed, by searching for an impersonal principle (or principles) to account for all change in reality, the so-called first Western philosophers contributed a great deal to the critique of mythological thinking and super-naturalism in general (Bueno 1974). Thinkers such as Thales, Anaxagoras, and Empedocles thought that this ontological principle was of physical nature.

Although it is impossible to downplay the philosophical importance of this first form of materialism, the course of philosophy in many cases made clear its limitations; after all, in our universe we find entities and processes that are not easily ontologically reducible to physical realities. Accordingly, Bueno, parallel to Bunge, identified physicalism with "vulgar materialism".³⁶ Within this broad category, we also find nineteenth-century "energetism", which reifies energy as an *entity*, instead of seeing it as a *property* linked to the mutable character of cosmic matter.³⁷

For discontinuous materialism, although neither abstract nor psychological contents would exist without physical matter, both have ontological properties that transcend physical matter. They represent, in Bunge's terminology, "qualitative

³⁴ Bueno also noted that the determination of the properties of M is richer than the medieval *via remotionis*, which, if taken seriously, should lead to a total negation of the World, and therefore to absolute nothingness: see Bueno (1972), p. 60. According to Bueno, the "autocontextual analysis" of the World leads to the conclusion that it does not exhaust reality in general. ("Autocontextual" here means "without epistemologically seeking to leave the World"). In Bueno's logical terminology, since the World (M_i) is a contingent and finite reality, and absolute nothingness (as Parmenides already knew) is impossible, the World structurally needs a complementary set: M /absolute reality. Bueno put forward this thesis as follows: $(M_i \subset M) \ \& \ (M \not\subset M_i)$.

³⁵ This primitive form of physicalism, nevertheless, poses specific difficulties to the Greek atomists, since for them the void is as real and necessary to explain the world as physical atoms.

³⁶ Bueno (1972), p. 26; Bunge (2006), pp. 74, 129, 208.

³⁷ Bunge (2006), p. 14; (2010), pp. 65, 103.

novelties” (without even contemplating the question of the ontological irreducibility of biological and chemical matter to physical matter). Despite this, downwards reductionism (in both its ontological and epistemological versions) has a grain of truth: namely that everything existent or possible in the universe necessarily implies physical entities and processes. When materialist deniers of *qualia* such as Patricia S. Churchland, Paul Churchland and Dennett pretend to “explain” psychology only by neurobiological/computational processes, they fall into several contradictions. They start from a phenomenological world constituted by colors, smells, desires, thoughts and memories. From such “world”, they regress to the neurobiological processes that constitute these phenomena, denying the starting world as illusory or non-existent (Churchland 1984; Churchland and Sejnowski 1993; Dennett 1991). But they lack the theoretical tools to specify the ontological status of such non-existence or “illusion”. To declare that psychological contents are non-existent is just a performative contradiction. On the other hand, to declare them *illusory* falls into another contradiction: *illusion* is a concept that belongs to “folk psychology”; as such, it should make no sense to eliminative materialism (Ongay 2019; Pérez-Jara 2014).

For discontinuous materialism, the false dilemma between the hypostatizers and the deniers of M_2 should be totally overcome. In truth, eliminative materialism implicitly accepts the theological principle whereby the existence of psychological processes imply a metaphysical soul or spirit. As such, eliminative materialism is an unconscious victim of theological propaganda.

The brain can be seen from several perspectives: microphysical, macrophysical, chemical, and neurobiological. In the macroscopic perspectives, the specific anatomy and physiology of the nervous system, or of the organism in general, is given to the scale of *qualia*. This apparent contradiction (the brain has organoleptic properties that depend on itself) has been pointed out several times.³⁸ From it, current philosophers such as Markus Gabriel attempt to get rid of “neuroconstructivism” (2015, 2017). But, due to its radicalism, Gabriel’s presentation of neuroconstructivism is mainly a straw man. If we use the metaphor of the brain (or the nervous system in general) as a distorting or filtering camera, we can say that when the camera records itself, it indeed introduces a significant degree of “translation” or “distortion”. But the camera (in this case, the biological organism endowed with a nervous system) is real, and if it disappears, so does the image.

If physicalism, in its ontological versions, leads to dead ends, its epistemological versions do not do better. The epistemological impossibility of physicalism seems obvious: from the point of view of the physical sciences, neither biological evolution, unconscious psychological drives, the fall of the Roman Empire, economic cycles or religious beliefs can be explained at all. So far, I have pointed out some important philosophical convergences between Bueno’s discontinuous materialism and Bunge’s systemic materialism. Both are inclusive materialisms that reject physicalism, considered as a form of vulgar materialism. I could not agree more

³⁸ Schopenhauer’s metaphysics is inconsistent as a result of this (Pérez-Jara 2011).

with Bunge's statement that "the physicalist oversimplifies and impoverishes both reality and our knowledge of it."³⁹ Nevertheless, one important difference between discontinuous materialism and systemic materialism is that Bunge, in many of his writings, poses physical matter as the absolute ground of everything possible and existent. In this view, there is an ontological ladder from physical matter, as the basement of the universe, to technical matter (Bunge 1977, 2003, 2006, 2009, 2010). But discontinuous materialism rejects the claim of physical matter as the absolute ground of reality. We have philosophical reasons to hold that physical matter, as we currently know it, is an ontological episode of unknown material realities. The macrophysical world is given at our organoleptic scale, including our use of modern technology (such as radio telescopes) and our mathematical artifacts. As we have seen, this scale would fade away without nervous systems, and therefore it introduces an important but unavoidable degree of "distortion" in our knowledge of reality. In turn, we can access the microphysical reality only indirectly through our macrophysical technology and mathematical constructs. As such, our current knowledge of the microphysical "world" should not be reified as some kind of metaphysical absolute $\acute{\alpha}\rho\chi\acute{\eta}$.

Nevertheless, an oft overlooked consideration arises here: hypostatizing is a non-binary operation; as such, it admits *degrees*. From this perspective, Bunge's systemic materialism correctly critiques the hypostatization of physical matter performed by physicalism. But at the same time, systemic materialism gives physical matter an a priori autonomous reality, represented as the primordial ground of reality. But we do not have philosophical reasons to reject the existence of (in Bunge's terminology) sub-levels of ontological reality "below" physical matter. In this line, Romero (2018) has brilliantly speculated with the idea of an ontological level from which spacetime and physical matter would emerge. This ontological level, therefore, would not be *physical*, but "pre-physical" or "proto-physical".⁴⁰

In any case, these interesting approaches can only be illuminated by future ontological analysis based on updated scientific research. Importantly for discontinuous materialism, though, this possibility does not mean that we will eventually know everything about those ontological levels or dimensions; Bueno (1990) always emphasized, following Du Bois Reymond's distinction, the difference between *ignoramus* (in the present moment, for whatever scientific or philosophical reasons) and *ignorabimus* (always, for structural reasons). There are many processes that fall into the category of the *ignorabimus* without having to speculate about what exists beyond our known universe. For instance, how many times did Sargon of Akkad dream with flying lions, if ever? How many stones and fishes were in a given part of the Nile four thousand years ago? What is the exact number of orgasms

³⁹ Bunge (2010), p. 178.

⁴⁰ Naturally, for both discontinuous and systemic materialism, to explore the possibility of material realities that are "prior" to space-time would lead us to the ontological problem of conceptualizing changeable *but not temporal* materialities. In this, spatio-temporal events should be considered as a specific type of unknown changeable events. But here, of course, we are in the constant danger of getting lost in the dark jungle of non-empirical speculations.

that Messalina had throughout her intense but short life? Omniscience is but a contradictory limit ideal.

3.8 The Ontological Problems of Spiritualism, Idealism and Psychologism (or the Hypostatization of M_2)

The hypostatization of psychological life or the psyche is at least as old as animist thinking, which existed long before the emergence of the first states (Tylor 2010[1871]; Harris 1990). Nevertheless, and in a similar way as physical matter, the hypostatization of the psyche also comes in degrees. Psychologism or mentalism would be the softest versions of this reification, whereas ontotheological spiritualism, with its defense of the existence of a Divine Mind (or *minds*) before the creation of the material world, would represent its most radical form.

In a middle ground between psychologism and ontotheology are the paradoxical forms of spiritualism represented by primitive animism. Indeed, some forms of animism are physicalist, since they identify souls and spirits with physical realities such as gases and light (Bueno 1972; Pérez-Jara 2014). Is this “ethnological spiritualism” then a form of materialism? Not for discontinuous materialism, because this philosophy emphasizes the organic-bodily (and therefore, “solid”) nature of every living being. Gases or electromagnetic waves, although often confused with supernatural spirits or souls by our ancestors, cannot be, based on substantial ontological reasoning, living beings.

Metaphysical spiritualism derives from ethnological spiritualism, but goes beyond it (although the frontiers are sometimes blurred, as in the spiritualism defended by some religions: see Pérez-Jara 2014). In metaphysical spiritualism, there is a disconnection between physical matter and the spirit. In the Western tradition, metaphysical spiritualism can be tracked down to Anaxagoras’ *νοῦς*, Xenophanes’s and Socrates’s god, and Plato’s demiurge. This form of spiritualism achieved its highest degree through Christian metaphysics, which combined the former Jewish mythopoetic thinking with metaphysical ideas from the Greek tradition. Nevertheless, there are also crucial differences: for Greek philosophy, matter is necessary and uncreated, whereas for Christian metaphysics it has been created *ex nihilo* by an infinite, absolute and perfect divine spirit. In this new scenario, the hypostatization of psychological life reached unprecedented proportions, at least in the Western world. With the fall of the *ancién regime*, Christian metaphysics began to be secularized through the philosophical works of thinkers such as Hume and Kant. German idealism arose as one of the most important products of this historical process. The medieval understanding of God as *Dator Formarum* was transformed into Kant’s transcendental consciousness, Fichte’s absolute ego, Schelling’s absolute, Hegel’s absolute spirit, and Schopenhauer’s intellect.

On the other hand, Hume’s and Stuart Mill’s psychologism and mentalism can be considered an even softer version of this hypostatization. They downplay the

organic and operatorial side of human existence, while reducing abstract concepts, ideas and relations to psychological processes. But they did not advocate for the absolute independence of the mind with respect to the nervous system; they just suggested it as a *possibility*.

Against all these philosophies, discontinuous materialism opposes any attempt to hypostatize the psyche. All aspects of the human and other forms of animal psyche, from perception to memory, thoughts and desires, only make sense in relation to a highly evolved organism equipped with a nervous system that interacts with other physical living and non-living entities in an spatio-temporal eco-environment. Basic but key psychological contents such as anxiety, fear, calm, joy and pleasure make no sense at all to entities that do not interact with an external world that can be threatening and dangerous or rewarding and pleasant; similarly, memories, desires and goals make no sense without temporal possibilities.

Regarding the non-supernatural origin of psychological life, Bueno followed the so-called theory of trophic origin (2009, 2016). According to this view, psychological contents are not superficial epiphenomena of certain parts of the terrestrial biosphere. Rather, they are a set of biological devices, such as hunger, thirst, fear, and memories that are key to the survival of such organisms. To contend that they do not exist or, at least, are an “illusion” without any ontological weight, enters in contradiction with a true scientific (and therefore non-biased) reading of evolutionary biology and cognitive neuroscience (Bueno 2000; Ongay 2008; Pérez-Jara 2014).

In other places, I have defended a theory of “ontological schemes of intersection” to account for the complexity of the human psyche (Pérez-Jara 2014, 2016). In this view and in line with Bueno’s argumentation, it is the ontological intersection of various heterogeneous material dimensions (physical, chemical, neurobiological, sociocultural) that makes the “generation” or “emergence” of thoughts possible, such as the ones the reader is having right now. If we remove one of these dimensions (such as neuroplasticity or the sociocultural environment) then the psychological life would either totally disappear (as in the case of deep brain injuries) or be drastically impoverished (as in the case of a human raised in isolation or in an environment without other humans).⁴¹

One key conclusion of the necessity of these intersections is that the theological thesis of the existence of a literal, personal and non-spatiotemporal mind simply consists in the syntactical or verbal possibility of being able to place those words into the same sentence. Naturally, this verbal possibility should not be confused with

⁴¹ This theory of the ontological schemes of intersection is a good example of a virtuous circle between sciences and philosophy; methodologically, it prevents the reductionisms of many scientists who start out with a wrong ontology. An example of this are the neurobiologists who seek to explain the generation of the “ego” by neurobiological activity alone (Damasio 2005), without accounting for the complex sociocultural networks of interactions. Ontologically, it prevents (or at least puts in their place) the idle talk of science-ignorant “philosophers” about culture or consciousness as hypostatizable realities.

a real ontological possibility and the materialist denial of disembodied minds should not be taken to be a dogmatic begging of the question, as I hope to have shown.

Those authors who claim that is not possible to explain the appearance or emergence of M_2 from M_1 on the grounds that *qualia* have ontological properties “radically different” from physical, chemical and biological matter should keep in mind that, unless we postulate the eternal and absolute existence of M_2 (as ontotheology and radical panpsychism do, for instance), *we always have to explain the coming into existence of M_2 from ontological realities that are not M_2* . This simple thesis, which is nonetheless controversial to both theists and radical reductionists, should be considered basic by any coherent materialist philosophy.

3.9 The Ontological Problems of Platonism (or the Hypostatization of M_3)

Through Pythagoras and, above all, Plato, the hypostatization of *eidetic matter* (concepts, ideas, abstract relations) enters into the history of Western metaphysics. This kind of hypostatization has received several names, such as Platonism, Pythagorism, objective idealism and essentialism. Although we have seen that spiritualism, in the form of animism, predated the inception of strict philosophy, it seems harder to track down some sort of mythopoetic essentialism. Anthropologists have studied how many gods in Antiquity and even the Neolithic are prosopopoeias of abstract ideas, such as wisdom, trade, writing, love, justice, good, evil, balance, chaos, death and war (Honko 1984). Behind the poetic personifications of these archetypes lies a primitive but interesting form of proto-essentialism. Therefore, a non-literal interpretation of these divinities could be seen as an ancient form of “projecting to the heavens” (or to the “underground”) abstract ideas that, later in history, will be completely “despersonified”.

Essentialism achieved a new ontological meaning through Christian metaphysics, in which (at least for key ontotheologians such as Augustine and Leibniz), God has created the World out of nothingness, but using Platonic ideas as models or an architectural map. Countering any manner of reification, Bueno always emphasized that abstract concepts and relations do not have any kind of ontological independence respect to advanced animals that interact with the physical world (1972, 1992, 1993, 2016). Nevertheless, this does not mean that “essentialism” or objective idealism is entirely wrong. We should always restrain ourselves from using a binary logic for complex philosophical issues. According to this, and against nominalism, the partial truth of essentialism is the reality of human abstractions along with their structural key role in our ordinary, mythical, scientific and philosophical world. For instance, our understanding of physical matter is very far from our ancestors’ primitive, mythological understanding: among other things, it is structured upon mathematical relations and entities, such as distances, vectors, equations and so on. These abstractions are “objective” because they are not

reducible to subjective passing feelings or emotions, not because they are subject-independent. Thus, although they would not exist without psychological processes, a psychologist can say little or nothing about mathematical theorems or logical tables of truth.⁴² The objectivity of eidetic matter can be clearly observed in the universal and necessary truths obtained by mathematics and logic. Many of these truths have no application whatsoever to the real material world, whereas others do have it. For instance, no sculptor will ever be able (no matter how hard she works) to sculpt a regular decahedron, because it contradicts Euler's formula on the topology of polyhedrons.⁴³ This does not mean that the real world follows mathematical laws: the universe has structural and processual material dimensions that, under some circumstances, can be formalized in mathematical equations. But our mathematical devices are human creations that would disappear without us.

Due to this lack of existence outside the human sphere, mathematical and logical entities are called "fictions" by Bunge. Nevertheless, Bunge also emphasizes, against mathematical conventionalism, that they are not arbitrary at all, due to the rigorous methods of building such fictions.⁴⁴ Due to the emotional charge of the word "fiction", Gustavo E. Romero (2018) prefers to talk about "conceptual artifacts", a more neutral and less misleading term.⁴⁵ Currently, one important example of the problems generated by the hypostatization of M_3 is the belief in cosmological singularities as real entities, instead of concepts. The criticism of the reification of singularities is key for a correct understanding of current cosmology (Romero 2013).

Human psychological life is greatly shaped by abstract systems of concepts and relations, as every sociologist and anthropologist knows very well. This constitutes a key difference from more primitive kinds of psyches in the so-called animal kingdom. For Bunge's systemic materialism, M_3 , as a set of fictions, is not "real" and therefore is not material. But this assumption is mainly based on the terminological decision of using "real" solely for subject-independent entities, properties and processes.⁴⁶ For discontinuous materialism, we can consider many entities, properties and processes as real, even if they would fade away without humans or others kinds of animals. Dependence (or mutual-dependence) does not

⁴² In Bueno's formal terminology, this idea is expressed as follows: $M_3 \not\subseteq M_2$. The non-arbitrary nature of many realities of M_3 is one of the main arguments that discontinuous materialism has against Hume's and Stuart Mill's "psychologism".

⁴³ Bueno (1972): 77, 354.

⁴⁴ Bunge (2006), pp. 205–209.

⁴⁵ Bueno stressed that neither mathematics nor logic would exist without typographic symbols (which belong to M_1). Nevertheless, the ontological difficulties lay in explaining the relationships between such physical symbols and the eidetic relations and entities with which the mathematician and logicians also work, specifically in the "most abstract" parts of mathematics (in contrast, for instance, with Greek arithmetic and geometry). For more on this issue, see the discussion in this book between Carlos Madrid Casado and Gustavo E. Romero.

⁴⁶ Bunge (2006): 27.

mean irreality. Colors, memories and political ideas, for instance, are real, even if they would disappear from the universe if every nervous system died.

3.10 The Complex Interplay of Continuities and Discontinuities in the Three Genera of Materiality

These contradictions inherent to the reification of each genre of materiality led Bueno to argue for their structural interdependence. M_1 , M_2 , and M_3 are both incommensurable and inseparable (Bueno 1972). *Incommensurability* means that no genre of materiality can be reduced to another or other ones, because each one of them has its own ontological qualitative properties. At the same time, *inseparability* means that no genre of materiality can be thought as completely independent from the others.

Although Bueno's terminology strongly recalls Simmel's "Three Kingdoms" and Popper's "Three Worlds", the doctrine of the three genera of materiality is a very different ontological theory. Specifically, Bueno criticizes Simmel's and Popper's hypostatizing metaphysics. For Bueno, the three genera of materiality are not three kingdoms or worlds; on the contrary, they are discontinuous but inseparable ontological dimensions of a common and unitary World/Universe (1972, 1993, 2016). However, for a non-idealist thinker, the ontological thesis of the inseparability of the genera implies the surprising argument that M_1 cannot exist without M_2 and M_3 . Without further explanation, it seems that discontinuous materialism states that microphysical particles, far galaxies, Precambrian rocks and dinosaurs would not exist without animals, humans and their abstract artifacts. In *Ensayos Materialistas*, Bueno proposed the following "mental experiment" to prove the ontological inseparability of the genera of materiality: if you mentally suppress one genre, the others also disappear, because they form an indivisible structural unity.⁴⁷ For a philosophy based on the modern sciences, this seems quite clear in respect to M_2 and M_3 . But why should M_1 "disappear" without M_2 and M_3 ? Bueno's answer is the following: cosmic contents are not what disappear without us, but rather the animal/human scale through which they appear to us.

That physical matter's phenomenological/organoleptic side would fade away without humans and animals is easily proven by modern cognitive neuroscience: beyond organisms equipped with decentralized or centralized nervous systems there is a "material plenum" composed of electromagnetic waves, gravitational waves, gases, particles and so on. According to Bueno's terminology, our visual perception is *apothetic*, i.e. we visually and aurally perceive from a distance (by contrast, taste and touch are *parathetic* perceptual processes) when our brains' processes of filtering the external world perform a sort of *emptying* of the materialities between us and the objects we perceive (Bueno 1992, 1993). Denying causal actions from

⁴⁷ Bueno (1972), p. 366.

a distance as contradictory, we always have to presuppose the existence of the “evacuated materialities” between us and the perceived objects. Otherwise, the causal connections that physically, chemically and biologically allow perception would disappear and we would fall into the realm of supernatural magic.

Bueno called *kenosis* this process of perceptual evacuation (1992, 1993). As a result, we can interact in the World, perceiving predators, shelters and sources of food. The brain “translates” electromagnetic wavelengths, mechanical wavelengths and gases to colors and shapes, sounds and smells. Therefore, the argument that the phenomenological world does not resemble the “absolute reality” outside our organisms and nervous systems does not imply ontological idealism at all. On the contrary, it is a condition to make it possible to understand advanced living beings as biology conceptualizes them (i.e. interacting in complex environments surrounded by predators, preys, food, shelter or danger). That *qualia* are not independent from subjects is a “secret” far older than Galileo or Descartes. Greek atomists already knew that absolute reality is quite different from the organoleptic world. Following this inspiration, Greek skeptics such as Sextus Empiricus. (1933) underlined how psychic contents change depending on different animal species. From this fact, rather than a skeptical conclusion, Bueno drew his “zoological argument against idealism”: if other species of animals perceive the world in ways different from ours, this means that the universe is not an idealist human creation. There is something absolutely real and independent from humans and other kinds of animals that, depending on different perceptual organs and physiological structures of different nervous systems, is perceived on different scales. Bueno called this conception “hyperrealism” (Bueno 1992, 1993).

Realism, in its broadest sense, is the condition of possibility of any materialist ontology. We can imagine and scientifically conceptualize organoleptic Precambrian or Jurassic scenarios without actual humans ever living there. Even further, we can phenomenologically imagine scenarios that, because of their adverse physical or chemical conditions of temperature, atmospheric composition, etc., are incompatible with human life or even life at all. Those scenarios are not illusions, but the epistemological result of human scientific “translation”, “filtering” or “adjustment” of an absolute material reality.

Also crucial to note here is that non-phenomenological physical matter, from quantum matter to the core of the stars, is undoubtedly real, but also given on our *scale*. Each day more precise and rigorous, our access to quantum matter is always mediated by human interactions with macroscopic technologies, mathematical artifacts and other epistemological tools. These scientific interactions, as objective and rigorous as they can be, always imply a significant degree of distortion in relation to a hypothetical (although contradictory) omniscient knowledge of absolute reality. In other words, our knowledge of the microphysical world is also “filtered” by our finite and corporeal human scale.

A key idea in Bueno’s ontology is the need to presuppose some unknown processes given in absolute reality (M) behind the formation of the psyche and eidetic realities. Although totally necessary to account for the genesis of M_2 and M_3 , the physical, chemical, and biological processes given in M_1 are not

enough. But since M_1 is the product of an epistemological process of “translation”, “selection”, “filtering” or “adjustment” of an absolute reality, it seems “closer” to ontological-general Matter than M_2 and M_3 . Among other things, this means that there is no symmetry among the genera of materiality. All these analyses about the complex interplay between cosmic and metacosmic material processes presuppose the key idea of discontinuity. Nevertheless, despite its central position in Bueno’s philosophy, the idea of discontinuity still needs major development. Far from being univocal, the notion of discontinuity has several modulations and a general typology of the main discontinuities that we can find in reality is missing in Bueno’s analysis. Bueno (2009, 2016a) gave examples of inter-genre discontinuities of materiality (such as the discontinuity between psychological processes and physical and chemical realities, in counter to radical reductionism and eliminative materialism) and intra-genre discontinuities of materiality (such as the discontinuities that we can find between the different psyches of different human beings or the discontinuities in the psyche of a singular person, for instance, between his most rational projects and his most primitive unconscious drives). Still, despite the importance of these classifications, further analysis is needed to properly conceptualize the key idea of discontinuity. For instance, taking into account the ideas of discontinuity and separability, we could distinguish between:

1. *Discontinuous materialities that are inseparable.* Materialities that are discontinuous in some respects, but continuous in others. The relationships between the psyche and the nervous system are a good example of this, since they are discontinuous in some aspects (*qualia* is not ontologically reducible to brain processes considered from an electrochemical point of view) but continuous in others (alterations in the biochemistry of the brain always imply psychological changes, and the brain’s death implies the disappearance of the psyche).
2. *Discontinuous and separable (or independent) materialities.* This idea is perfectly exemplified by Plato’s principle of sympleké. Against absolute holism, not everything is connected with everything else (or in other words, not every cosmic process has in reality an effect or an echo upon all the other processes). For that reason, for instance, what a cute cat is doing now in a specific house of a small village in Hokkaido not only does not have any effect upon far galaxies of the universe; we do not have reasons either to believe that it has any kind of causal effect on the New York Stock Exchange. Key in chaos theory, the butterfly effect does not imply an absolute monism of order. That a butterfly can have a huge effect in certain conditions does not imply that it necessary will have it. the butterfly effect is just one extreme example of what *could* happen under very specific circumstances.
3. *Continuous materialities that are nonetheless separable.* We are surrounded by entities in which certain aspects of their continuity can be broken, i.e. made discontinuous: every cook is expert in this kind of materialities when preparing fish, meat or vegetables in the kitchen!
4. *Continuous and inseparable materialities.* In the absence of empirical examples, it seems that we have to consider this as the “empty set”.

One of the conclusions of this basic typology is that the ontological interplay between continuities and discontinuities goes beyond the Platonic principle of *symploké* as Bueno put it forward. That there are at least partial connections in the universe is simply a matter of fact.⁴⁸ But absolute holism is more difficult to refute. Against it, Plato emphasized that not everything is connected to everything else. I agree with Bueno in considering this thesis as a key discovery in the history of Western philosophy. The problem is that the principle of *symploké*, important as it is, is not deep enough. We have seen, for instance, that there are materialities necessarily connected that, at the same time, are (partially) discontinuous. And there are also other objections to the Platonic formulation: (a) In terms of philosophical consistence, while the principle of *symploké* can be explicitly found in the *Sophist*, in other key texts such as the *Timaeus*, Plato explicitly argues that everything is connected with everything else; (b) the epistemological principle “if everything were connected to everything else, we would know nothing” does not distinguish between an absolute knowledge (the divine omniscience) and human and animal knowledge, always incomplete and partial. Even starting from the *symploketik* structure of matter and knowledge, there are enough partial connections and relationships between entities, processes, concepts and ideas that we are unable to manage all of them. In practice, we are always ignorant of innumerable connections and relations that structure the realities that surround us, along with the mechanisms and processes that they enable in the universe. Nevertheless, that does not prevent human knowledge from existing and exercising its power.

In addition to the need for a more elaborate typology on the different types of discontinuity, the core idea of matter as discontinuous multiplicity opens the problem of an unwanted *regressus ad infinitum*. Thus, if every real or possible entity is a multiplicity, we would fall into what I suggest calling a “fractal metaphysics”, in which quarks and leptons should also be considered as multiplicities along with their components, *ad infinitum*. This would bring us, in James Ladyman’s and Don Ross’ terminology, “turtles all the way down” (2007). But we do not have any reasons at all, neither scientific nor philosophical, to hold such imaginary *regressus ad infinitum*. Therefore, there should be components of multiplicities that are not composed of multiplicities themselves. The nature and origin of such metaphysical “atoms” or “monads” also evidently face their own ontological problems (Pérez-Jara 2014). For a non hypostatizing metaphysics, such elements should never be considered as absolutely isolated or disconnected from everything else. Nevertheless, if discontinuous materialism accepts their possibility, it should also have to change its general definition of matter. Facing a similar problem, Bunge’s systemic materialism states that everything real is either a system (which is a type of multiplicity) or a part of one (aside from non-systemic aggregates, we do not have reasons to believe, for instance, that an electron is a system). Material, for systemic materialism, is what is mutable (and therefore has energy as a property).

⁴⁸ Hume’s radical skepticism and Leibniz’s pre-established harmony, for instance, lead to important contradictions (Pérez-Jara 2014).

Could we say, paraphrasing Bunge, that everything material is either a changeable semi-discontinuous multiplicity or a part of one? And if so, what ontological status should we assign to these material entities that are components of multiplicities but are not multiplicities themselves? A possible way of solving this metaphysical puzzle is by denying the ontic character of the ultimate constituents of reality. In other words: moving away from substance metaphysics and embracing a process ontology that emphasizes the complex interplay of continuities and discontinuities that structures every material process. Such process ontology would be totally compatible with Bueno's doctrine of "actualist" or "dynamic" substantialism. But, in any case, it would require to redefine Bueno's ontological definition of matter beyond a discontinuous multiplicity.

In his early *Ensayos Materialistas*, Bueno preferred to emphasize plurality against the monism defended by Soviet materialism (*Diamat*). In later years, he also stressed discontinuity, this time against theological monism and reductionist or vulgar materialism. But the fact that discontinuous materialism, as any other coherent philosophical materialism, denies any attempt to hypostatize either the mind (M_2) or abstract concepts, ideas and relations (M_3) is clear indication of the key importance of the idea of continuity for this system of thought. After all, if psychological processes were totally discontinuous with respect to physical matter, spiritualism would be right, just as essentialism or objective idealism would also be correct if concepts and abstract relationships were totally discontinuous with respect to biological, chemical and physical processes. In terms of their specific qualitative properties, the "laws of logic" constitute a hiatus from psychic activity, just as psychic activity presents a gap relative to the electrochemical processes given in nervous systems. Similarly, chemical reactions do not follow from quantum realities, and I have already mentioned some good reasons to argue that quantum matter could constitute another hiatus from an unknown pre-physical reality. Despite these structural ontological discontinuities or rifts, the "laws of logic" do not exist without quantum matter, which means that there are also constitutive powerful lines of continuity between these *tissues* (or *stroma*) of reality.

Given the necessity of all these clarifications, another conclusion that arises from the foregoing analysis is the drive to overcome the binary opposition between monism and pluralism (or the trilemma between monism, dualism and pluralism). An illustrative example: Hegel's "monism" clearly emphasizes ontological discontinuities in reality, from physics and chemistry to the ontological phenomenon of death.⁴⁹ In the majority of metaphysical systems, the interplay between continuities and discontinuities is usually too complex to be "solved" in such simplistic terms as "monism" or "pluralism" without many clarifications and nuances.

⁴⁹ Hegel (2010[1813–1832]), p. 322.

3.11 The Ontological Problems of the *Scala Naturae*

That the anthropic scale through which the universe appears epistemologically adjusted to us is radically finite and imperfect is shown by the fact that we are unable to fully explain the organoleptic macrophysical “world” from our current knowledge of the microphysical “world”. That means that the ontological arrow “from the quark to the Jaguar” (Gell-Mann 1994) is not possible unless we postulate unknown but intermediate material magnitudes or dimensions (Bueno 1993). Based on our current scientific and philosophical knowledge of the universe, we can find a *metaphysical hiatus* among several of what Bunge’s systemic materialism calls “levels of emergence”. In sciences such as sociology, cultural anthropology, political science and history we can explain, using Bunge’s methodology, the appearance of new realities such as the family, clans, social classes, companies, governments, etc. following a systemic-emergent approach (that is, by studying the appearance of a new property through the dynamic of a system’s composition, structure, mechanism, and environment). Yet, as Bunge (2003) recognizes, the situation seems less optimistic for other sciences. It seems hard to deny our current partial ignorance about the specific ontological mechanisms through which biological matter emerged from chemical matter, or the emergent properties of the organoleptic world arise from biosystems equipped with neurosystems. Accordingly, Bunge (1980) presented his “psychoneural monism” as a well-supported *hypothesis*, once the other alternative theoretical options (such as dualist spiritualism, physicalism, functionalism, etc.) are discarded because they lead to dead ends. Our scientific knowledge on how *qualia* wholly depends on specific neurobiological activities is gaining a progressively stronger footing. Nevertheless, the fact remains that neither systemic materialism nor discontinuous materialism (or any other theoretical framework I know) can fully explain the specific ontological mechanisms through which macrophysical morphologies arise from quantum matter or psychic life arises from certain organisms under certain circumstances.

The partial knowledge or ignorance of the ontological mechanisms that explain *novelty* in the World should not be confused with the problem of the structural discontinuities that constitute reality. There are ontological hiatuses and epistemological hiatuses. While the former imply the latter, the opposite is not always true. In systemic materialism’s terminology: to understand the mechanisms that enable the emergence of qualitative novelties in the universe is fully compatible with emphasizing the discontinuities between the new emergent realities and the components of inferior levels. There is a discontinuity between the emergent qualitative properties of a cell (birth and death, cellular homeostasis, metabolism) and its chemical components, regardless of our (partial) scientific knowledge of the specific mechanisms that enable chemical matter to form cells as biological organisms or proto-organisms. Even if we knew all the ontological mechanisms involved, the ontological discontinuity between biological and chemical matter would remain. What’s more: the knowledge about the ontological mechanisms behind emergent processes does not mean that sciences form a *continuum*. Against epistemological

monism, a physicist, for instance, is totally unable to explain divorces or the Fall of the Roman Empire. Similarly, and despite the fact that societies and psyches necessarily imply a physical substratum, a psychologist or a sociologist is unable to explain quantum matter or spacetime. Despite these epistemological discontinuities, and against the perspective of thinkers such as Dupré (1993), different scientific approaches and perspectives can be used to develop unitary theories. The integration of, for instance, biological, psychological, economic, political, and sociocultural perspectives into a broader and unitary theory of family does not cancel the structural irreducibility between these particular scientific perspectives (for more on this issue, see my discussions with Harman and Ongay in this volume).

Systemic materialism's ontological levels of emergence and discontinuous materialism's genesis of the genera of materiality (and within these genera, the genesis of new things and qualities) lead to one of the most difficult problems of philosophy: accounting for the *Scala Naturae* and the *ontologically new*. It seems quite clear that absolute continuism leads to a neophobic metaphysics incompatible with our scientific and philosophical knowledge of the universe. Neophobia, nevertheless, also comes in degrees. Absolute neophobia seems only possible by falling into radical Parmenidean metaphysics. Indeed, although absolute continuism rejects that new dimensions, fields or genera of materiality come into existence, its aggregationist ontology allows "new temporal aggregations". In every tiny instant of time, the universe is slightly different or, in other words, there is some manner of ontological novelty. For that reason, emergence should not be confused with novelty in general. Otherwise, physicalism would also be an emergentist metaphysics. The only way to avoid such conclusion is to limit the idea of emergence to the ontological dynamics that allow for, in some multiplicities, the appearance of ontological dimensions or properties not reducible to the components of the multiplicity (such as family/individuals, reasonings/words, biological organism/chemical components).

We could call "neology" the philosophical study of *novelty*. Bueno (1993) used the idea of "anamorphosis" to take the appearance of new ontological dimensions of matter into account, against both radical reductionism and "creationist" emergentism, which he mainly identified with C. Lloyd Morgan's and Samuel Alexander's ontologies (see Alexander 1920; Bueno 1993; Morgan 1912, 1933). Both Bueno's and Bunge's non-reductionist materialisms are critics of "neophobic" metaphysics. As such, they accept the appearance, arrival, emergence or coming into existence of novelty in reality. According to neophobic metaphysics, ontological novelty would always be an illusion, since reality is always already "pregnant" of what *apparently* arises as "new" for us.

This neophobic preformism has materialist and spiritualist varieties. For instance, "Platonic theism", if consequent, must end up contending that the *creatio ex nihilo* of the universe is just an actualization or "material duplication" of one of the infinite possible worlds contained in God's infinite and eternal intellect. True, matter appears through the divine act of creation, but the "essence" of every existent and possible thing (included matter) preexisted eternally.

On the other hand, neophobic materialism is very well characterized by both downwards and upwards reductionism. The former is well represented by physi-

calism and its post *Big Bang* radical descendant reductionism, whereby everything “apparently new”, from the emergence of organisms with psychic life to empires, civilizations and philosophical systems, is ontologically reducible to the most basic entities and processes of microphysics. Lastly, materialist ascendent reductionism is well represented by Parmenides, for whom novelties are reducible to illusions that fade away in the immutable absolute totality of Being.

Bueno strongly criticized the idea of *Scala Naturae*, whereas Bunge defended it. But the idea of *Scala Naturae* is not univocal. When Bunge talks about the universe’s ontological hierarchies, he emphasizes (for instance against perspectives such as Bruno Latour’s “flat ontology”) that there are structural asymmetrical relationships in the universe: for instance that political systems imply biological, chemical, and physical realities, but gamma rays (unless we endorse radical constructivism) do not imply political or economic systems. Such asymmetrical material relationships necessarily imply ontological discontinuities, against upwards and downwards ontological reductionisms. Of course, political organizations or other social systems, for instance, can have a powerful impact in biological, chemical, or physical systems, but these interactions do not deny the structural ontological asymmetry between political processes and physical ones.

According to this approach, there are not material things more real than others. Ontological dependence and asymmetry do not mean lesser ontological weight. But how Bueno’s discontinuous materialism can criticize both the *Scala Naturae* and radical epistemological constructivism? In order to delve further into this key metaphysical issue, it is necessary to pay attention to some open questions related to the genesis of realities that belong to different genera of matter. For instance, we can find the philosophical problem of determining when we can rigorously talk about the emergence of psychic activity. Bueno defended that we can locate psychic life in certain primitive Precambrian unicellular organisms (2009, 2016). Nevertheless, what are the main arguments to talk about the existence of psychological activity in non-neural organisms? Some current scientists talk about the ability of unicellular organisms to “learn”, such as the *Physarum polycephalum*. But is that a metaphorical or a literal learning, and what is the criteria to make that distinction? Should we consider the “answers” of some unicellular organisms, thanks to their plasmatic membranes, as purely “mechanical” (i.e. without any psychological content)? Beyond its metaphorical use, up to what point can we talk about teleology without M_2 without falling into animism? The ontological analysis of teleology in evolution stills need many future developments. Bueno’s thesis of the inseparability of M_1 , M_2 and M_3 also creates specific problems for M_3 . We saw how abstract artifacts shape human psychology, but we also know that the most primitive organisms that carry on psychological activity do not have any kind of M_3 , at least as we know it. However, shouldn’t the existence of primitive psychological contents in a worm without M_3 lead us to better reconsider Bueno’s thesis of the absolute inseparability of the genera of materiality (Pérez-Jara 2004)? The only way that seems open is to explore the genera of materiality in analogical terms; as such, a

worm's psychological activity can be considered as belonging to M_2 only in analogy with human "advanced M_2 ", which requires M_3 . Primitive animals, a human fetus or little baby do not have M_2 in the same sense as educated adult human beings. Similarly, many animals are able to innately perceive archetypal situations, which can be considered as a primitive form of M_3 . In any case, this "analogical thesis" requires further development lacking in Bueno's special ontology.

My conclusion here is that Bueno's critiques of a creationist *Scala Naturae* continue being totally valid. Nevertheless, Bueno's usual rejection of any notion of *Scala Naturae* depends on his traditional theory of the absolute inseparability of the genera of materiality. This theory, in turn, rests on the thesis of the anthropic filtering of the World, which presents, in my opinion, important problems that deserve to be explored in order to understand the metaphysical core of discontinuous materialism.

3.12 The Anthropic Filtering of the World and the Ontological Problems of Correlationism

The metaphor of filter mainly comes from Neo-Kantian philosophy, and, as such, it privileges the filtering subject (Friedman 2008). But what is what is *doing the filtering* in discontinuous materialism? As we have seen, for Bueno, if we remove the animal and human scale(s) through which the World unfolds, the only knowledge that we can have about absolute reality is mainly negative and very limited. I hold that this leads us to what I suggest to call "the problem of the filtered filters". The nervous system as we know it, for instance, is a *filtered reality* (an organoleptic biosystem belonging to M_1). But at the same time it is a key piece in the process of *filtering* that constitutes the zoothropic/anthropic World, which includes biosystems themselves. Similar considerations could be said about other filters that we can determine in the constitution of the World. I contend that the only way to break this dangerous vicious circle is to determine more intersections and analogies between absolute reality and the animal and human World. In Bueno's philosophy, the intersections between the World and ontological-general Matter are mainly "structural" (i.e. they point to very few common structural features between the World and absolute reality, such as multiplicity, co-determination, discontinuity, changeability). This overlooked problem, which involves the interplay between general and special ontology, is so complex and important that it merits its own section.

This "problem of the filtered filters" is linked to discontinuous materialism's Kantian and Post-Kantian roots. Although late Bueno strongly criticized Kant's philosophy (2004b), we have seen up to what point discontinuous materialism's ontology is explicitly inspired by key Kantian and Post-Kantian ideas. In this way, Bueno's thesis that the World is given to the animal and human scale and that humans and other kinds of animals are given to the scale of the World strongly

recalls Schopenhauer's argument that "the World is as dependent upon us, as a whole, as we are dependent upon it in detail."⁵⁰

Given these convergences between Kantian and Post-Kantian philosophies and discontinuous materialism, the obvious question arises: is it legitimate to place discontinuous materialism within the category of "correlationist philosophies"? A key idea in phenomenology and in Heidegger's philosophy, "correlationism" has been recently popularized again by the critiques of so-called "speculative realism". This is a present-day movement that incorporates several different (and sometimes antagonistic) philosophical systems whose main point in common is the critique of (at least) the so-called "strong correlationism". As far as I know, Bueno never talked or wrote about this movement. Despite this, I think that a partial comparison between it and discontinuous materialism is very useful to illustrate and further look into the problematic relationships between discontinuous materialism and the metaphysical problem of correlationism.

Quentin Meillassoux, whose "speculative materialism" is usually placed within the broader category of speculative realism, defines correlationist ontologies as "the idea according to which we only ever have access to the correlation between thinking and being, and never to either term considered apart from the other."⁵¹ According to this definition of correlationism, therefore, "there are no objects, no events, no laws, no beings which are not always-already correlated with a point of view, with a subjective access."⁵² Meillassoux also summarized the correlationist position in this way: "we can't know what the reality of the object in itself is because we can't distinguish between properties which are supposed to belong to the object and properties belonging to the subjective access to the object."⁵³ Or as stated even more clearly by another key figure in the speculative realism movement, Graham Harman: "correlationism holds that we cannot think of humans without world, nor without humans, but only of a primal correlation or rapport between the two. For the correlationist, it is impossible to speak of a world that pre-existed humans in itself, but only a world pre-existing humans for humans."⁵⁴

According to this depiction of the so-called correlationist circle, we are unable to think an X outside of thought without thinking it, and therefore we cannot escape the circle of thought (Harman 2010). For Meillassoux, the correlationist circle cannot be escaped, but only radicalized from within.⁵⁵ Through this radicalization, we can think of the existence of a reality prior to humans. Meillassoux calls this reality

⁵⁰ Schopenhauer (2001[1847]): 29.

⁵¹ Meillassoux (2008), p. 5.

⁵² Ennis (2011), p. 38.

⁵³ Meillassoux (2007), p. 409; see also: Gratton and Ennis (2014), Harman (2011a).

⁵⁴ Harman (2009), p. 122.

⁵⁵ Brassier (2007), pp. 408–438; Harman (2010). Let's compare this claim with Heidegger's late philosophy, according to which we need *Ereignis* to explain *Ereignis* itself; as the last presupposition of knowledge, we cannot go further than it (Sheehan 2014). But unlike speculative realists, Heidegger never tried to achieve knowledge of absolute reality beyond the general idea that entities are independent from *Dasein*.

“ancestrality” or the “ancestral realm”.⁵⁶ Of course, this circle is an idealist prison with no windows, doors or cracks. As such, it prevents us from having any contact with absolute reality. Speculative realists propose different ways of escaping from the correlationist circle, from art to mathematics. Since discontinuous materialism defends the co-determination between animals and their *filtered* World, it could be considered only as a partial correlationist philosophy.⁵⁷

The main reason why discontinuous materialism does not fully fall into the correlationist circle is that the structural unity between animals and the World should not be identified with an absolute correlation “between thinking and being” in general, to use Meillassoux’s terms; there is only a partial co-determination between certain biological organisms and the scale of the World they interact with. This “partial correlation” or “zoothropic codetermination” could only partially be assimilated to what Meillassoux calls “weak correlationism”, which includes unknowable realities outside the correlation (this would contrast with “strong correlationism”, which would deny such absolutely independent realities).

For Harman, the correlationist circle and its philosophical traps mainly occur when we privilege knowledge as the most important relation between entities.⁵⁸ But, following an almost-flat ontology, Harman states that the relationships between the “human knower” and the “known world” are just a kind of relation among others. As such, and as sophisticated as they can be, they do not have greater ontological weight than other kinds of relations between objects. Both humans and impersonal objects are entities that relate with other objects, distorting them. According to this, Kantian and Post-Kantian philosophy seems particularly obsessed with just one kind of relation between entities/objects. From Harman’s perspective, *every* object always *withdraws* from its relations with other objects, not only from humans and animals. Every relation between objects is always *finite*. Therefore, objects are unable to be reduced to their relations with other objects (Harman 2002, 2011b); objects, Harman claims, only “know” caricatures of other objects (Harman 2013, 2016).

I won’t deny that there is a point of convergence between Harman’s thesis of the withdrawal of objects and discontinuous materialism’s inexhaustibility of the World’s entities and processes in human knowledge and interactions. However, in

⁵⁶ Meillassoux (2009), p. 10.

⁵⁷ As every complex ontological term, correlationism is a non-univocal ideal; there are different kinds of correlationisms, and each is so to different degrees. Bryant (2014) recognizes this as follows: “Correlationism presumably comes in a variety of different forms, and is therefore not restricted to theories focused on the relation between mind and being. Thus the relation between transcendental ego or lived body and the world in phenomenology would be one variant of correlationism, while the relation between language and being in Wittgenstein, Derrida and Lacan, or between power and knowledge in Foucault, would be other variants. In each case we encounter the claim that being cannot be thought apart from a subject, language or power.”

⁵⁸ From this point of view, knowledge can be replaced by phenomenological openness, and we would be in the same problem: Heidegger privileges the *Dasein* over the rest of entities, because thanks to it the rest of entities can show, in changing contexts, their “being”.

its quest to overcome anthropocentrism and preserve the metaphysical dignity of objects, I find that Harman's philosophical rhetoric falls dangerously close into an updated form of *animism*. Paradoxically, several "new materialisms" also fall into this peculiar animism, even if they do not seem happy with this term, often linked to the "colonial mindset" of classic cultural anthropologists. Thus, for instance, Jane Bennett correctly critiques outdated views of matter as something passive and dull, in contrast to active "life". But, following Latour, she considers edibles, commodities, storms and metals as "quasi agents" (Bennett 2010). Latour (2005), trying to overcome the traditional distinction between object and subject, on the one hand, and nature and culture, on the other hand, levels every entity to the category of "actant". This actant's ontology postulates the agency of every entity of the universe.

This issue is naturally strongly related to the question of anthropocentrism. According to Harman's view, "philosophies of access" (such as Kant's, Husserl's and Heidegger's) privilege human beings over other entities. In contrast, for discontinuous materialism, humans' epistemological privilege does not constitute any argument for metaphysical anthropocentrism. Humans are just contingent and ephemeral tiny entities "lost" in an infinite impersonal reality. With naive realism rejected as contradictory, to talk about the "anthropic scale" of the human world is as tautological as talking about the "cat-like scale" of cats' world. Without ignoring all its structural intersections, the World is partially "fragmented" at least into as many organoleptic scales as there are animal species with varying kinds of organs and nervous systems. It is just that human brains shaped under complex sociocultural contexts allow for epistemological possibilities unthinkable in other earthly species (such as writing books on speculative realism).⁵⁹

Following this brief comparison between discontinuous materialism and some speculative realist philosophies, we are now in a much better position to tackle discontinuous materialism's problem of the "filtered filters". Every coherent philosophy that denies the idea of *creatio ex nihilo* as absurd should end up demolishing the correlationist prison. The reasons could be summarized as follows: (1) animal and human consciousness is structurally *open* to things other than itself; (2) since this openness is unable to create things out of nothing, the factual existence of perception and cognition implies ontological realism; (3) dreams, hallucinations, illusions and fictions, therefore, are distorted imaginary combinations of real things; (4) the morphologies of the real things that we perceive and interact with are "filtered" through animal/human scale(s); (5) these filters are not immutable, but the product of millions of years of biological evolution and thousands of years of sociocultural development; (6) the fact that the phenomenological/organoleptic "world" would fade without us does not mean that it depends on "us": on the contrary, it mainly depends on a set of impersonal processes (physical, chemical, neurobiological, sociocultural) that are the conditions of possibility of egos them-

⁵⁹ Of course, this importance is linked to the planet Earth; to determine, in Max Scheler's words, "the Human Place in the Cosmos" (Scheler 2008[1928]) we have to consider exobiology's hypothesis and future findings.

selves, and therefore of “us”; and (7) the “structural unity” formed by humans and their anthropic World cannot be reified at all, since it is the product of the intersection of subject-independent material processes.

In conclusion: discontinuous materialism’s central problem of the “filtered filters” leads to what some speculative realists call the correlationist prison. The only way of escaping from such prison is to determine more intersections and stronger analogies between intracorrelative/animal realities and extracorrelative/absolute realities than Bueno did. For discontinuous materialism, as we saw, we can identify the following general properties of absolute reality: infinitude, multiplicity based on complex interplays of continuities and discontinuities, co-determination, mutability, eternity (i.e. impossibility of *creatio ex nihilo* and annihilation), non-phenomenological, non-psyche and non-eidetic. Of these general properties of absolute reality, we can identify, following Bueno’s theses, points of intersection with our World, such as multiplicity based on complex interplays of continuities and discontinuities, co-determination, mutability, absence of creations and annihilation (although the World cannot be considered eternal, since it is a finite and contingent episode of absolute reality). Bueno did not give any name to these convergent structural properties, but I do think that it would be fruitful to do such. I suggest, inspired by ancient Japanese philosophy, calling *Yūgen* (幽玄) the field of convergences and strong analogies between the zoothropic World in general and absolute reality.

Often used for Japanese aesthetics and metaphysics, *Yūgen* implies the meaning of a mysterious profundity of real things that, deeply impacting human affairs, transcends them. In the ancient Chinese philosophical texts the term was taken from, this concept was already synonym of “deep”, “dim” or “mysterious”. This deep awareness of reality is key for both Zen Buddhism and Shintoism (Marra 2001; Minh Nguyen 2019). The key idea I want to emphasize for my own philosophical interests is that *Yūgen* does not point to “another reality”, like the mystical experiences of medieval Christian mystics; rather, it points out at the absolute side of the “human reality” that surrounds us. As such, it points to a non-idealistic liminality.⁶⁰ Having a “glimpse” into some dimensions of absolute reality through the critical observation of our World goes far beyond aesthetics in its usual sense; it has a pure metaphysical meaning also strongly related to important contents of the non-phenomenological knowledge achieved by sciences.

In Western “theological terms”, we saw how Bueno mainly used negative theology to determine the main attributes of absolute reality. Bueno (1993) even held that the idea of M fulfills similar functions to the idea of *Deus absconditus*.

⁶⁰ The concept of *Yūgen* has the virtue of not dragging unwanted meanings from other possible Western concepts, worn out by millennia of ontotheological thinking. In particular, my use of this concept stresses that animal “worlds” are finite and transient episodes of a mysterious absolute and impersonal reality. From this point of view, both otherworldly metaphysics and immanentist metaphysics are equally blind.

Since this “apophatic”⁶¹ approach leads to dead ends, a “cataphatic”⁶² treatment is also needed. In particular, the classic doctrine of the *analogia entis* can be useful to overcoming the short circuit caused by the problem of the “filtered filters” that threatens to disrupt the very ontological core of discontinuous materialism. For instance, we could say that, although the nervous system is an organoleptic morphology (and therefore, it would fade away without animals), our knowledge of it points to a totally mind-independent system which has strong analogies with the “phenomenological nervous system” we interact with.

Bueno’s thesis that we can only know some structural properties of absolute reality, but not the inner contents of reality, could be considered as a form of “structural realism”. Among others, Henri Poincaré and Bertrand Russell held a similar view in their respective philosophies of matter when they defended that the intrinsic qualitative characteristics of the contents that compose reality are unknowable: only some basic structural features can be known. Radical structural realism, therefore, seems always linked to a radical correlationism of contents.

3.13 On Meaningfulness, the Sacred, and God

The analysis of the partial merging between absolute reality and the animal worlds gives rise to the final important questions that I consider key to understand discontinuous materialism’s metaphysics: the ones about meaningfulness, the sacred, and God. Let’s begin with the first notion. If, as I have contended, the ontological space of convergences and strong analogies between the World and absolute reality should be widened, would “meaningfulness” form part of it? In Heideggerian terms, the *being* of an entity is its meaningful presence for human beings. The World itself is defined by such meaningfulness (Heidegger 1977[1927], Sheehan 2014). The same entity, depending on the biological and sociocultural context, can be a shelter, an object of art, a weapon, a sacred object or just junk to be thrown away. Of course, there are limits in this process; in Zubiri’s terms, the *cosa-real* determines the possibilities of the *cosa-sentido*. Thus, with liquid water we cannot make a table (Zubiri 2008[1962]). Accordingly, I talk here about material contexts studied by sciences: absolute reality imposes its own “laws” on the possibilities of human and animal spheres of meaningfulness. This important phenomenon could be called reality’s *muzzle*.

If, more specifically, we focus on *values* within the general sphere of meaningfulness, discontinuous materialism affirms that they necessarily imply animals that interact with complex realities in terms of operative possibilities. It is in such bio-social interactions that some entities and processes can appear as either good or evil, pleasant or nightmarish, stupid or genius, beautiful or disgusting. This leads to the

⁶¹ That is, negative, stressing differences between the absolute and the worldly.

⁶² That is, positive, emphasizing similarities.

thesis that absolute reality is *valueless* and, more generally, *meaningless*. But this does not corroborate nihilism. Absolute reality is meaningless as it is colorless or tasteless; values and sense are not part of its nature, such as smells and colors are not part of abstract mathematical entities. A blind person is deprived of vision; a tree can be deprived of its branches and leaves, but absolute reality is not “deprived” of meaning. Those thinkers who accept the meaningless character of absolute reality but hold at the same time that, if there is not an absolute meaning-making God, nihilism is unavoidable, seem to fall into an ontotheological trap. Western nihilism lives under the large shadow of the ontotheological God.

Brassier (2007) encourages us to embrace nihilism on the basis that the universe is meaningless and is heading towards cosmic extinction. But Brassier’s nihilistic conclusion is a *non sequitur* that also seems influenced by Western ontotheological propaganda. As long as there are animals with advanced nervous systems, meaningfulness is completely real, and, since Western absolute nothingness is a contradictory idea (Pérez-Jara 2014), reality will never be annihilated. Where is then the dreadful nothingness in which Brassier tries to support his metaphysics?

Through his long philosophical career, Bueno (1972, 1990, 2007) defended that, in a similar way to the Western idea of absolute nothingness, there are very important philosophical reasons to hold that the traditional ontotheological idea of God is contradictory. As a mosaic of incompatible ideas brought together into an impossible totality, the ontotheological God is in truth a pseudo-idea.⁶³ Bueno called this view “essential atheism”, for it not only denies the existence of God, but its very “essence” or “formal constitutive” (Bueno 2007). Although not very widespread, this position according to which the ontotheological God cannot exist contrasts with “existential atheism”, according to which God is a possible being, but we do not have good arguments to defend His existence. This seems to be Bunge’s position and as such, discontinuous materialism’s atheism is much closer to Gustavo E. Romero’s atheism, which also denies the very possibility of the Western ontotheological God, based on the arguments of philosophers such as Martin (1989), Martin and Monnier (2003).

In his classification of the different types of atheisms, Bueno also distinguishes between ontic atheism (applied to minor gods) and ontological atheism (applied to ontotheology’s Supreme Being). Nevertheless, I suggest calling Bueno’s ontological atheism ontotheological atheism, understood as a type of ontic atheism, for there are non-ontic conceptions of the divinity, such as Heraclitus’ God, some forms of

⁶³ Some theologians, accepting the non-existence of the idea of God, defend the existence of God nonetheless. Elsewhere I have called this position “the taboo of the idea of God” or the “iconoclasm applied to the idea of God” (Pérez-Jara 2014). These positions are plays of words, for there are very good philosophical reasons to hold that ontological possibility is a prerequisite of existence. Heraclitus and Nicholas of Cusa recognized, in their own way, that the contradictory character of God is an essential part of His mysterious nature. But this view only makes sense if “contradictory” is replaced by “paradoxical”, since finding literal contradictions in the notion of something, including the idea of God, is the best way of determining its ontological impossibility (Ongay 2020; Pérez-Jara 2004, 2005, 2014).

apophatic theology, Heidegger's "Last God", or those defended by some "Asian theologies" associated with Shintoism, Buddhism, or the Kyoto School of philosophy. With substance metaphysics' "ontocentrism" discarded, entities do not exhaust reality, for there are also other real ontological dimensions, such as properties, relations, states and processes.

With very few exceptions, and following an ancient trend, Christian ontotheology has had a tendency to represent the divinity through literalist (or, at best, strongly analogical) ontic anthropomorphism. Such mythological tendency is the result of interpreting poetic metaphors that come from a variety of human cultural spheres in a word-for-word way.⁶⁴ Despite their undeniable political and cultural functionalism, the literal interpretation of these metaphors transforms the depth of these ideas into a more-than-often childish mythological product incompatible with a critical philosophy supported on scientific findings.⁶⁵

The theological literalist (or, at best, strongly analogical) anthropomorphism or zoomorphism implies what I have elsewhere called the hubris or hemorrhage of psychism (Pérez-Jara 2014). This hemorrhage happens on both the mythological and most abstract and metaphysical side of ontotheology. This anthropomorphism or zoomorphism does not limit itself to advocating the ubiquity of primitive forms of psyche, as in some animist worldviews; on the contrary, in ontotheology it escalates to the highest levels of the psyche represented by a divine absolute ego. In Aquinas's terms, God, as *Ipsum esse subsistens*, is identified with the *Ipsum intelligere*. Among other things, this means that every possible and real entity has been designed, planned and created *ex nihilo* by a Supreme Mind or Spirit. Despite the ontological discontinuity (against emanantism and pantheism) between the Creator and the creatures, the Divine Psyche, therefore, penetrates into every domain of reality.

The excessive or even monstrous proportions that the figure of the ego attains in ontotheological worldviews contrast with the tiny or even non-existent proportions that it takes on in some religious and non-religious psychophobic worldviews, in which the ego is considered as a mere illusion (Bueno 2016a; Pérez-Jara 2014).

⁶⁴ From the family sphere (God as Father), the political sphere (God as King of the Universe and Lord of the Armies), the juridical sphere (God as Judge), the medical sphere (God as Savior), livestock-raising sphere (God as Shepherd) and the artistic or technological sphere (God as Supreme Architect). In fewer occasions, the metaphors that are taken literally come from the animal spheres. Examples of this are represented by God as an unknown creature that terrorizes us, as happens in some mystical experiences (Bueno 1996).

⁶⁵ Bueno brilliantly argued that anthropomorphic metacosmic foundations are, in truth, an imaginary and distorted duplication of real contents of our World (Bueno 1972, 1997). Therefore, the *Ens extramundanus*, along with His transcendental realm, are not really transcendental. Furthermore, when spiritualist worldviews try to explain the origin of life and humankind through living anthropomorphic entities (such as the supreme deities of Antiquity) they merely fall into a vicious circle. Only the ideas of *Deus Absconditus* or *Agnostos Theos*, when they are really stripped down from any literal anthropomorphic or zoomorphic imaginary, can be associated to a real transcendence relative to the animal and human World, and therefore to a criticism of the anthropomorphic foundations of the universe.

Between ontotheological psycho-hubris and eliminative materialism's metaphysical psychophobia, discontinuous materialism traces its middle-grounded path.⁶⁶

All things considered, for a materialistic worldview, associating some kinds of meaningful transcendence or liminality with the age-old ideas of the sacred and, within it, the divine, can only be done by breaking spiritualism's (and specifically ontotheology's) attempt to monopolize such notions. In several places such as his book *La fe del ateo*, Bueno (2007) explored a conception of the sacred compatible with materialism. Bueno held that the sacred should be understood as a set of non-harmonic objective values that form part of humans' different cultural systems: numina (such as the worshipped animals in Paleolithic religions), saints, and fetishes. Nevertheless, Bueno's conception leaves many important unanswered questions, such as the criterion of demarcation between mythic superstitions and the World's real sacred dimensions (even understanding this reality in a correlationist sense). The sacred as an objective dimension of meaningfulness is a pathway that has only ambiguously been explored by discontinuous materialism.

From this perspective, could we say that an ontic atheism is the condition of possibility of a non-literalist/mythological understanding of the sacred, and, therefore, of the divine? But what remains of these ideas once their mythopoetic interpretations are set aside, apart from the general notion of the *numinous* in Rudolf Otto's sense of a *mysterium tremendum et fascinans*? In order to answer this question, it is important to keep in mind that the idea of ontically atheistic religions is not an oxymoron at all. For instance, according to important interpretations of Shinto, *kami* (usually translated as gods or divinities) are not entities, but properties or manifestations of *musubi*. In turn, *musubi* is not an entity external to nature, but the inner force or principle behind harmony and life.

3.14 Conclusions

Given the limitations of a book chapter, my analysis of the main ideas of Gustavo Bueno's philosophy has not been exhaustive. It has not been neutral either, but philosophical, i.e. not merely a doxographical summary. I have pointed out the strongest points of discontinuous materialism along with significant open problems in this philosophy that remain to be properly solved. Trying to avoid any kind of binary logic, I have also pointed out both important convergences and divergences between discontinuous materialism and other philosophies, from negative theology to Bunge's systemic materialism, and current speculative realism. Expanding an idea already present in Bueno's *El Papel de la Filosofía en el Conjunto del*

⁶⁶ Naturally, this position does not imply the so-called logical fallacy of the middle ground; I am not talking about an "arithmetical middle". The scientific evidence is that the psyche generated by certain living beings, despite its undeniable ontological reality, only constitutes a tiny part of reality.

Saber (1970), I have identified hypostatizing thinking as the main theoretical enemy of discontinuous materialism. If mythological thinking's main pathology is the tendency towards literalist anthropomorphism and zoomorphism, the main pathology of metaphysics is the tendency towards hypostatization. Since, according to the legend, Medusa turned into stone changing and dynamic realities, I will call the "Medusa Effect" such tendency of metaphysics of hypostatizing realities that, due their very nature, cannot be hypostatized, for they are dynamic ontological realities structurally connected to other ones. Nevertheless, this does not mean that we have to accept absolute mutability; to begin with, I propose to distinguish between mutability of contents, and mutability of structures and mechanisms. Heraclitus already noticed the paradox that, for a process metaphysics, everything changes but change itself (which explains the importance of the ideas of Logos and God in his thinking). In Bueno's ontology, the general structural properties of multiplicity, codetermination, and symploké do not change (reality is always *plural* and so on). Although Bueno did not hypostatize such properties, his ontology lacks important analysis about them. For instance, if we reject neophobic metaphysics, it is obvious that plurality can increase or decrease: there is, for instance, more qualitative plurality in a universe in which advanced living beings have emerged and have developed complex social and artificial systems than in a universe in which this has not happened.

The best way of avoiding Medusa's gaze is to emphasize, as Buddha did thousands of years ago, that there is nothing absolutely autonomous in reality; every dimension of reality (whether an entity, a property, a relation, a state or a process) is partially continuous and discontinuous with other realities. Bueno used the Platonic idea of symploké to express this central thesis. Nevertheless, I have also argued that a general classification of the main kinds of continuities and discontinuities in reality, along with their mutual interplay, is mainly missing in Bueno's philosophy. Although Bueno went much deeper than Plato when analyzing the idea of discontinuity, much still needs to be done in this regard. Such analyses affect the very ontological core of discontinuous materialism.

Despite this absence, I have chosen to follow Bueno's later identification of his *materialismo filosófico* with *materialismo discontinuista*. Renaming this late syntagma as "discontinuous materialism", I have defended its relevance as long as it is properly understood: (1) *materialism*, for, positively, it identifies being with changeability and plurality, and negatively, it denies any possible hypostatization of psychic life and ideas; (2) *discontinuous*, for it rejects continuous materialisms, specifically both downwards reductionism (physicalism) and upwards reductionism (holism). As this philosophy defends that *both* continuities and discontinuities are a structural dimension of reality, a better syntagma is still to be explored ("partially discontinuous materialism" would indeed sound awkward!). As far as I am concerned, "discontinuous materialism" is a temporary expression that could be replaced in the future for a more precise one.

Although Bueno identified the rejection of disembodied living beings as the main characteristic of materialism in general, I have defended that the negative definition of materialism should be: (1) expanded to also include the denial of

hypostatized ideas, against objective idealism; (2) supplemented with a positive definition that identifies matter in general with changeability and plurality. Like the god Janus, materialism's two sides form a structural unity. What's more, the "positive" definition could be turned into a "negative" one (materialism as the ontology that denies the immutable and simple character of being), and the "negative" definition into a "positive" one (materialism as the ontology that affirms the bodily nature of every living being, along with the inexistence of ideas without some of these living beings). This does not change the fact that materialism needs to be defined by both what it is and what it is not. If, for instance, Schopenhauer can be considered as a materialist philosopher negatively, but not positively (because the Will is immutable), it is because Schopenhauer's metaphysics, despite all its merits, is internally contradictory (see Pérez-Jara 2011).

Discontinuous materialism also faces a structural problem that every philosophical system shares, as certain Greek skeptics already knew: to determine a philosophy's starting point in a non-axiomatic/dogmatic way. Since discontinuous materialism does not present itself as an axiomatic metaphysics, neither "materialism" nor "discontinuity" should be considered as starting points. On the contrary, this philosophy's "principles" or "pillars" belong to a set of virtuous circles. Thus, once the philosophical theses of the impossibility of disembodied living beings, hypostatized ideas, and absolute continuity in reality are well established, they become relative starting points for other philosophical analyses. As such, they would lose their "architectural privilege" if the theses of the possibility of literal incorporeal minds, ideas, and absolute continuity in reality could truly be demonstrated. The problem here is to determine the non-dogmatic philosophical perspective that is employed until for instance the theses of the impossibility of disembodied living beings and absolute continuity are reached. Being strict, even the "rules of logic" should not be taken for granted. For that reason, certain speculative realists proceed paradoxically, trying to demonstrate their theses in a logical way, only to end up declaring that the majority of rules of logic are contingent (Meillassoux 2009).

Bueno contended that, given all the known alternatives, the best way to proceed seems to confront possible philosophical answers for a given philosophical problem and choose the one that is neither contradictory nor supported on bad science (or no science at all). Of course, the problem here is to determine and properly justify the validity of the principle of non-contradiction and of science itself. Both tasks require a sound system of criteria to differentiate pseudo-science from true science, along with a sound philosophy of logic.

In my discussion of discontinuous materialism's main skeleton, I have mainly focused on the differences between reality given on the scale(s) of humans and other kinds of animals and absolute reality (i.e. which overflows and transcends every possible animal scale or perspective). Other criteria are possible, though; I have followed this one because is particularly useful and Bueno himself seemed to consider it the most appropriate. Every philosophical system is a palace with many doors and windows, and it is not always easy to know which is the best way to enter one. And, just as there are some palaces that are more luxurious than others (or that

at least seek to be), so too are there philosophies more ambitious and powerful than others.

Every true philosophy tries to determine some aspects of the ultimate nature of reality. Merely hold that human beings are unable to access the deepest bottom of reality, as many thinkers do, or that there is an infinite chain of explanations is to determine a key structural component of the very nature of reality. The search for the deepest or ultimate nature of reality leads to what I will call, for lack of a better term, “primordial facticity”.⁶⁷ Such search for reality’s primordial properties and levels of facticity implies the quest for the last ontological presupposition of reality that have, by definition, no explanation (since they explain everything else). This implies the why-question, which transcends the principle of causality itself (for there are non-causal reasons and motives, such as the ones studied by mathematics, psychology and sociology). Bueno often declared that Leibniz’s and Heidegger’s question on why is there something rather than nothing was wrong and superficial. In the case of Heidegger, I think that Bueno’s statement is not fair, since Heidegger himself also declared such question as superficial.⁶⁸ In the case of Leibniz, though, I think that Bueno was right in holding that reality, in general, cannot have a “why”. Bueno usually focused on the inadequacy of applying the principle of causality to reality, since every causal process implies a “material scheme” through which the cause will exert its influence. But Leibniz’s question implies that absolute nothingness should be such scheme, which is impossible (Bueno 1992).⁶⁹

But it is not only a cause what cannot be applied to reality in general, but any kind of reason, motive or explanation at all, since every reason implies entities and processes, and therefore reality. The why-question has therefore a limit: the *meta-why-question*. It makes no sense to ask about “the why of the why”. The existence of reality in general is the deepest primordial factum. Ontotheologians and Spinoza had a hint of this conclusion through their use of the contradictory idea of *causa sui*.

⁶⁷ The concept of “primordial facticity” has been previously employed by the phenomenological tradition. My use here, though, goes beyond correlationism and therefore acquires new meanings. It is important to make clear that the concept of primordial facticity has to be interpreted metaphorically. Indeed, facticity comes from the Latin *factum*, which is the neuter perfect passive participle of *facio* and the neuter perfect active participle of *feri*. But reality’s primordial facticity is not something that has been “done” by something or someone. Rather, it is the condition of possibility of every possible *doing*.

⁶⁸ With his usual unnecessary obscure prose, Heidegger declared: “Why then the ‘why’? Why and to what extent the mere necessity of the horizon of such a questioning, even if we entirely disregard whether this question refers to beings or not? (...) Inquiringly thinking ahead, we do not reach further than *Seyn* because *Seyn*—more originarily than Hegel thought—‘is’ nothingness. The consequence is that [we must] unmask that ‘why-question’ which lies in the foreground as a superficial question.” Heidegger (2006[1938/1939]), p. 237.

⁶⁹ Furthermore, there is not a dichotomy between being and nothingness, because absolute privative nothingness is a contradictory idea, and relative nothingness belongs to the realm of being in general. As Plato. (1993) made clear in the *Sophist*, every rational discourse implies relative non-being. Further considerations are required to take into account the concept(s) of nothingness or emptiness as understood by some Asian philosophies, from Neo-Taoism and traditional Japanese Buddhism to the Kyoto School of Philosophy.

Inspired by Henri Poincaré, some philosophers have talked about “brute facts” as facts that either have no explanation (Fahrbach 2005) or that we cannot explain (Hospers 1997). As such, the concept of “brute fact” is related to reality’s primordial facticity. But it cannot be identified, since the concept of brute fact is usually opposed to either an infinite regression of explanations or to the principle of sufficient reason.⁷⁰ And both infinitism and radical rationalism point to a ultimate feature of reality that does not have an explanation, i.e. point to reality’s primordial facticity.

God(s), Tao (道), Kami (神), Musubi (結ひ), Brahman, Sunyata, χάος, ἀρχή, mathematics and logic, matter and so on are attempts to conceptualize this facticity in some way. The search for this ultimate facticity goes beyond the contents and also inquires into reality’s primordial structure and mechanisms that allow everything else. For instance, does reality’s primordial facticity allow real change and novelty or only an illusion of them? Whatever answer we choose, it does not have an explanation.⁷¹

A significant number of philosophers often go through loops or hit metaphysical short circuits when they try to analyze reality’s primordial facticity. Leibniz himself answered the question on why there is something rather than nothing through the ontotheological God: as the necessary Being, the World is contingent and has been freely created by a personal God. But God and His divine properties do not have any kind of explanation, since they are the last presupposition of everything else. And since God is a Being who necessarily exists, He does not answer the question about “being and existence” in general. The question of reality’s primordial facticity cannot be answered by any particular being (even if it is the Supreme Being). Every entity presupposes beingness and existence in general. Before Heidegger, Schelling and Schopenhauer approached this view through their ideas of being as *Abgrund* (abyss) and *Grundloss* (without reason) respectively. No theological metaphysics or materialist philosophy can go much further than that. This is no epistemological limitation, but the result of confronting existence’s primordial facticity.

The metaphysical short circuits that unfold when trying to take reality’s primordial facticity into account are not, therefore, the monopoly of ontotheologians. Let’s take an interesting present-day example. Following Heidegger in his own peculiar way, Markus Gabriel defines facticity as “the fact that there is something rather than nothing—that is, that there exists anything at all.”⁷² But his definition of existence “as the property of fields of sense, namely that something exists in them”⁷³ falls

⁷⁰ The concept of reality’s primordial facticity is even further from the (on the other hand very interesting) concept of “contextual” brute facts held by Anscombe (1981).

⁷¹ If we hold (as I do) that change is an essential characteristic of reality, we could argue, for instance, that absolute immutability is an imaginary and impossible product of hypostatizing the concept of “now”. But this is not a true explanation of the necessity of change, for it is already supported on the factual structure of reality, which implies mutability and therefore human temporality.

⁷² Gabriel (2015), pp. 232, 133.

⁷³ Gabriel (2015), p. 232.

into circular reasoning. This is because every property and “field of sense” implies existence in general. Furthermore, Gabriel does not give a much deeper account of reality’s primordial facticity aside of stating that the World in capital letters does not exist, only an infinite plurality of fields of sense composed of entities that we can know as they are in themselves. For a materialist philosophy, furthermore, there is no “sense” without humans or other kinds of animals, so there cannot be an actual infinity of “fields of sense”.

Humans’ radical dependence on reality’s primordial facticity also explains, among other things, what I called “reality’s muzzle” in the face of relativism. Without any doubt, human societies can create all manner of extravagant and even surreal narratives and mythologies and believe in them blindly (Bueno 1996). And, indeed, in these extreme cases reality seems powerless to muzzle symbolic process. But, if we trust calm reasoning and logic, at the end of the day, reality’s facticity will impose its muzzle over us, marking what is imaginary and what is not, what is totally distorted and what is more accurate. Even if many radical social constructionists and idealists alike decide to downplay it, we can only ignore the muzzle at our own risk.

Despite the doubtless depth of Bueno’s ontological analyses, he never used a concept similar to reality’s primordial facticity or seemed particularly interested in what it implies. Nevertheless, it is easy to translate the ontological ideas that Bueno considered most important to the question of reality’s primordial facticity. In such translation, key dimensions of reality’s primordial facticity are the interplays of continuities and discontinuities that structure matter, the necessarily corporeal nature of every living being, and the structural and necessary co-dependence between animals and their organoleptic worlds.

Through the analysis of such facticity, and remembering the Platonic concept of χωρισμός,⁷⁴ we can safely say that there is no “absolute chorismos” between our organoleptic and theoretical World and absolute reality. On the contrary, I have defended that there is a set of absolute convergences and a wide field of analogies that oscillate between weak and strong. Hoping to capture some of them, I have recommended following and expanding the traditional Japanese concept of *Yūgen* (幽玄) from the perspective of a materialist philosophy.

For a truly materialist philosophy, such as Bueno’s, there is no cosmic or supracosmic τέλος for the appearance of animals and humankind; reality’s primordial facticity only allows, under certain circumstances, the emergence of living beings. As a part of this facticity, literal living beings require a solid organic or paraorganic body. Such living beings, in turn, and under some circumstances, allow for the emergence of metaphorical living beings, such as our dead ancestors’ cultural weight or characters of fiction, from the Sumerian gods to the Joker. Although they would fade away without human beings, these cultural creations have a metaphorical “life” of their own, even if it is not corporeal. Furthermore, they often exert an influence on human beings stronger than many literal living beings. For that reason,

⁷⁴ Chorismos: rift or gap.

Bueno's definition of materialism in general as the denial of disembodied living beings has to be reduced to "literal" living beings.

Animals allow for a metaphysical transcendence through which some contents of reality are, to different degrees, illuminated or open to the deep mystery of their own existence. To hold, in Hegelian terms, that reality is aware of itself through this transcendence held by animals bears the danger of treating "reality" in a simplistic monistic way. It would be more proper to state that there is no single space of openness, but rather multiple ones, although with important structural points of convergence between them. Every living being endowed with a nervous system is capable, in different degrees and ways, of a metaphysical ἀνάτρησις, a "perforation" that partially bores through reality.⁷⁵ And, as it is usual in physical perforations, animal *anatreseis* partially change and distort the contents through which they bore through. Due to the complexity of their nervous systems and sociocultural systems, such *anatreseis* of reality achieves a very peculiar situation in the case of humans. In different cultures and times of history, human artistic, religious, scientific and philosophical *anatreseis* always have the possibility of leading to reality's primordial facticity, which is the biggest meta-mystery of all, for it does not have any possible answer.

To treat this meta-mystery as a secret that, therefore, has an answer, is one of the main mistakes of so many religious and metaphysical worldviews. On the contrary, to treat this meta-mystery as a secret that lacks *but should have* an answer leads to either nihilism or existential angst. Discontinuous materialism could not be further from that position. Since for Aristotle στέρησις meant privation, I will call (if the reader forgives me for introducing one final neologism) "primordial steresis" to the position whereby reality is deprived of an ultimate answer.

Exploring all the philosophical consequences of the denial of such ultimate steresis, along with the determination, when possible, of the point to which we can determine a hierarchy of levels in the dimensions of reality's primordial facticity is among the key ontological tasks that remain open for future investigation on discontinuous materialism and metaphysics more generally.

References

- Alexander, J.C. 2004. Cultural pragmatics: Social performance between ritual and strategy. *Sociological Theory* 22: 527–573.
- Alexander, J.C. 2011. *Performance and Power*. Cambridge: Polity Press.
- Alexander, J.C. 2016. Dramatic Intellectuals. *International Journal of Politics, Culture and Society* 29(4): 341–58.
- Alexander, S. 1920. *Space, Time, and Deity* (2 vols). London: Macmillan.

⁷⁵ And we do not yet know whether future developments in AI will be able to generate psychic contents from artificial biosystems.

- Anscombe, G.E.M. 1981. *The Collected Philosophical Papers of G. E. M. Anscombe. Volume III: Ethics, Religion and Politics*. Oxford: Blackwell.
- Baert, P. 2005. *The Existentialist Moment: The Rise of Sartre as a Public Intellectual*. Cambridge: Polity.
- Baert, P. 2012. Positioning theory and intellectual interventions. *Journal for the Theory of Social Behaviour* 42(3): 304–325.
- Bennett, J. 2010. *Vibrant Matter: A Political Ecology of Things*. London: Duke University Press.
- Brassier, R. 2007. *Nihil Unbound: Enlightenment and Extinction*. Basingstoke: Palgrave Macmillan.
- Bryant, L. 2014. Correlationism. In *The Meillassoux Dictionary*, eds. Gratton, P., P.J. Ennis. Edinburgh: Edinburgh University Press.
- Bueno, G. 1970. *El Papel de la Filosofía en el Conjunto del Saber*. Madrid: Editorial Ciencia Nueva.
- Bueno, G. 1972. *Ensayos Materialistas*. Madrid: Taurus.
- Bueno, G. 1974. *La Metafísica Presocrática*. Oviedo: Pentalfa.
- Bueno, G. 1990. Ignoramus, Ignorabimus! *El Basilisco* 4: 69–88.
- Bueno, G. 1992. En torno a la doctrina filosófica de la causalidad. In *La Filosofía de Gustavo Bueno*. Madrid: Editorial Complutense, pp. 207–227.
- Bueno, G. 1992–1993. *Teoría del Cierre Categorial* (5 Vols). Oviedo: Pentalfa.
- Bueno, G. 1996. *El Animal Divino*. Oviedo: Pentalfa.
- Bueno, G. 1997. Los Límites de la Evolución en el Ámbito de la Scala Naturae. In *Evolucionismo y Racionalismo*, eds. E. Molina, A. Carreras, J., Puertas. Zaragoza: Institución Fernando el Católico & Universidad de Zaragoza, pp. 49–87.
- Bueno, G. 2000. *Televisión: Apariencia y Verdad*. Barcelona: Gedisa.
- Bueno, G. 2004a. *La Vuelta a la Caverna. Terrorismo, Guerra y Globalización*. Barcelona: Ediciones B.
- Bueno, G. 2004b. Confrontación de doce tesis características del sistema del Idealismo trascendental con las correspondientes tesis del Materialismo filosófico. *El Basilisco* 35: 3–40.
- Bueno, G. 2007. *La Fe del Ateo*. Madrid: Temas de Hoy.
- Bueno, G. 2009. El Puesto del Ego Trascendental en el Materialismo Filosófico. *El Basilisco* 40: 1–104.
- Bueno, G. 2013a. *Ensayo de una Definición Filosófica de la Idea de Deporte*. Oviedo: Pentalfa.
- Bueno, G. 2013b. *Sciences as Categorical Closures*. Oviedo: Pentalfa.
- Bueno, G. 2016a. *El Ego Trascendental*. Oviedo: Pentalfa.
- Bueno, G. 2016b. Primer memorándum de Materialismo Filosófico. *El Catoblepas* 168: 2.
- Bueno, G. 2019. *The Happiness Delusion. Debunking the Myth of Happiness*. Oviedo: Pentalfa
- Bunge, M. 1977. *Treatise on Basic Philosophy. Vol. 3: The Furniture of the World*. Dordrecht: Reidel Publishing Company.
- Bunge, M. 1980. *The Mind–Body Problem: A Psychobiological Approach*. Oxford: Pergamon Press.
- Bunge, M. 2003. *Emergence and Convergence: Qualitative Novelty and the Unity of Knowledge*. Toronto: University of Toronto Press.
- Bunge, M. 2006. *Chasing Reality: Strife over Realism*. Toronto: Toronto University Press.
- Bunge, M. 2009. *Political Philosophy: Fact, Fiction and Vision*. New Brunswick: Transaction Publishers.
- Bunge, M. 2010. *Matter and Mind: A Philosophical Inquiry*. New York: Springer.
- Churchland, P.M. 1984. *Matter and Consciousness: A Contemporary Introduction to the Philosophy of Mind*. Cambridge: MIT Press.
- Churchland, P.S., and T.J. Sejnowski. 1993. *The Computational Brain*. Cambridge: MIT Press.
- Dennett, D. 1991. *Consciousness Explained*. Boston: Little, Brown.
- Dupré, J. 1993. *The Disorder of Things*. Cambridge: Harvard University Press.
- Engels, F. 2012[1883]. *Dialectics of Nature*. London: Wellred.
- Ennis, P.J. 2011. The transcendental core of correlationism. *Cosmos and History: The Journal of Natural and Social Philosophy* 7(1): 37–48.

- Fahrbach, L. 2005. Understanding brute facts. *Synthese* 145(3): 449–466.
- Friedman, M. 2008. History and philosophy of science in a new Key. *Isis* 99: 125–134.
- Gabriel, M. 2015. *Why the World Does Not Exist*. Cambridge: Polity.
- Gabriel, M. 2017. *I am Not a Brain: Philosophy of Mind for the 21st Century*. Cambridge: Polity.
- Gell-Mann, M. 1994. *The Quark and the Jaguar: Adventures in the Simple and the Complex*. New York: Holt Paperback.
- Harman, G. 2002. *Tool–Being: Heidegger and the Metaphysics of Objects*. Chicago: Open Court.
- Harman, G. 2009. *Prince of Networks: Bruno Latour and Metaphysics*. Melbourne: Re.press.
- Harman, G. 2010. I am also of the opinion that materialism must be destroyed. *Environment and Planning D: Society and Space* 28(5): 772–790.
- Harman, G. 2011a. *Quentin Meillassoux: Philosophy in the Making*. Edinburgh: Edinburgh University Press.
- Harman, G. 2011b. *The Quadruple Object*. United Kingdom: Zero Books.
- Harman, G. 2013. Undermining, overmining, and duoming: A critique. In *ADD Metaphysics*, ed. J. Sutela. Aalto: Aalto University Design Research Laboratory, pp. 40–51.
- Harman, G. 2016. *Immaterialism: Objects and Social Theory*. Cambridge: Polity.
- Harris, M. 1990. *Our Kind: Who We Are, Where We Came From, Where We Are Going*. New York: Harper Perennial.
- Harrison, P. 2015. *The Territories of Science and Religion*. Chicago: University of Chicago Press.
- Hegel, G.W.F. 2010[1813–1832]. *The Science of Logic*. Cambridge: Cambridge University Press.
- Heidegger, M. 1977[1927]. Sein und Zeit, ed. F.W. von Herrmann. Frankfurt am Main: Vittorio Klostermann.
- Heidegger, M. 2006[1938/39]. *Mindfulness*. London: Bloomsbury Academic.
- Honko, L. 1984. The Problem of Defining Myth. In *Sacred Narrative: Readings in the Theory of Myth*, ed. A. Dundes. Berkeley: University of California Press.
- Hospers, J. 1997. *An Introduction to Philosophical Analysis*. New York: Routledge.
- Damasio, A. 2005. *Descartes' Error: Emotion, Reason, and the Human Brain*. London: Penguin Books.
- Ladyman, J., D. Ross, D. Spurrett, and J. Collier 2007. *Every Thing Must Go: Metaphysics Naturalized*. Oxford: Oxford University Press.
- Latour, B. 2005. *Reassembling the Social: An Introduction to Actor–Network–Theory*. Oxford: Oxford University Press.
- Marra, M.F. 2001. *A History of Modern Japanese Aesthetics*. Honolulu: University of Hawaii Press.
- Martin, M. 1989. *Atheism: A Philosophical Justification*. Philadelphia: Temple University.
- Martin, M., and R. Monnier (eds.). 2003. *The Impossibility of God*. New York: Prometheus.
- Meillassoux, Q. 2007. Speculative realism: Presentation by Quentin Meillassoux. *Collapse* 3: 408–449.
- Meillassoux, Q. 2009. *After Finitude: An Essay on the Necessity of Contingency*. London: Continuum.
- Minh Nguyen, A. 2019. *New Essays in Japanese Aesthetics*. Lanham: Lexington Books.
- Morgan, C.L. 1912. *Instinct and Experience*. London: Methuen.
- Morgan, C.L. 1933. *The Emergence of Novelty*. London: Williams & Norgate Ltd.
- Ongay, Í. 2008. Entre el hábito y el instinto. Cuestiones ontológicas y gnoseológicas concernientes a las ideas de “conducta” y de “evolución”. *El Basilisco* 39: 3–36.
- Ongay, Í. 2019. Mente y Materia: una revisión de la filosofía de la mente de Mario Bunge. In *El último ilustrado. Homenaje al centenario del nacimiento de Mario A. Bunge*, ed. A. Martino. Buenos Aires: Eudeba.
- Ongay, Í. 2020. New (and old) atheism(s) reconsidered. In *Atheism Revisited. Rethinking Modernity and Inventing New Modes of Life*, eds. S. Wróbel and K. Skonieczny. New York: Springer.
- Pérez-Jara, J. 2004. Análisis de la Idea de Ego trascendental en el sistema kantiano. *El Basilisco* 35: 77–84.
- Pérez-Jara, J. 2005. Materia y racionalidad: sobre la inexistencia de la idea de Dios. *El Basilisco* 36: 27–64.

- Pérez-Jara, J. 2008. El Ego Trascendental como Ego lógico en el materialismo filosófico. *El Catoblepas* 80.
- Pérez-Jara, J. 2011. La importancia del cuerpo como “constitutivo formal” de todo viviente en la filosofía de Schopenhauer. *Thémata. Revista de Filosofía* 44: 424–438.
- Pérez-Jara, J. 2014. *La Filosofía de Bertrand Russell*. Oviedo: Pentalfa.
- Pérez-Jara, J. 2016. Principios y problemas abiertos del materialismo discontinuista. *Studia Iberica et Americana. Journal of Iberian and Latin American Literary and Cultural Studies* 3: 165–191.
- Plato. 1993. *Sophist*. Cambridge: Hackett Publishing Company.
- Romero, G.E. 2013. Adversus singularitates: The ontology of space–time singularities. *Foundations of Science* 18(2): 297–306.
- Romero, G.E. 2018. *Scientific Philosophy*. New York: Springer.
- Rorty, R. 1981. *Philosophy and the Mirror of Nature*. Princeton: Princeton University Press.
- Sacristán, M. 1968. *Sobre el Lugar de la Filosofía en los Estudios Superiores*. Barcelona: Editorial Nova Terra.
- Scheler, M. 2008[1928]. *The Human Place in the Cosmos*. Illinois: Northwestern University Press.
- Schopenhauer, A. 2001[1847]. *On the Fourfold Root of the Principle of Sufficient Reason*. Illinois: Open Court.
- Sextus E. 1933. *Outlines of Pyrrhonism*. Cambridge: Harvard University Press.
- Sheehan, T. 2014. *Making Sense of Heidegger: A Paradigm Shift*. Lanham: Rowman & Littlefield Publishers.
- Tylor E.B. 2010[1871]. *Primitive Culture Researches into the Development of Mythology, Philosophy, Religion, Art, and Custom*. Cambridge: Cambridge University Press.
- Zubiri, X. 2008[1962]. *Sobre la Esencia*. Madrid: Alianza Editorial.

Chapter 4

Quantum Matter



Gustavo E. Romero

Abstract Quantum mechanics is a fundamental theory that represents physical processes at atomic and sub-atomic level. It is an extraordinarily successful theory, but its interpretation has been the subject of endless controversies. Quantum mechanics and its further developments such as quantum field theory have been invoked to justify beliefs in idealism, the independent existence of the mind, infinite worlds, and almost anything imaginable. In this chapter I review the basic assumptions of both quantum mechanics and quantum field theory and present an analysis of their ontological implications. I evaluate the concept of matter in the light of both theories and conclude that, far from being idealistic theories, they agree with a fully materialistic view of the world.

4.1 Introduction

Quantum mechanics is a fundamental theory of physics developed in the first decades of the twentieth century. Based upon insights on micro-physical processes obtained by such figures as Max Planck, Albert Einstein, Louis de Broglie, and Niels Bohr, the theory achieved its mature form in the 1920s–1930s thanks to the work of Werner Heisenberg, Max Born, Pascual Jordan, Erwin Schrödinger, Paul Dirac, and Wolfgang Pauli, among others. Although the original goal of quantum mechanics was to correctly represent the physical processes involving elementary particles and atoms, the theory was later applied, also with great success, to explain macroscopic phenomena such as superconductivity and superfluidity. The final formalism is already exposed in early textbooks as the famous treatises by Dirac (1930) and von Neumann (1955, originally 1932). The interpretation of this formalism, however,

G. E. Romero (✉)

Instituto Argentino de Radioastronomía (IAR) (CONICET; CICPBA; UNLP), Villa Elisa, Buenos Aires, Argentina

Facultad de Ciencias Astronómicas y Geofísicas, Universidad Nacional de La Plata, La Plata, Provincia de Buenos Aires, Argentina

© Springer Nature Switzerland AG 2022

G. E. Romero et al. (eds.), *Contemporary Materialism:*

Its Ontology and Epistemology, Synthese Library 447,

https://doi.org/10.1007/978-3-030-89488-7_4

has resulted in endless controversies. Early surveys of the interpretations of quantum mechanics by Margenau (1954) and Bunge (1956) already reflect the wide range and variety of views on the foundations of the theory. A detailed discussion of the different interpretations in a historical perspective is offered by Jammer (1974). More recent discussions can be found, for instance, in Lewis (2016) and Norsen (2017). Almost anything speakable and even many unspeakable things have been said about quantum mechanics, to use a famous figure of speech by Bell (2004).

Aversely to classical theories of mechanics and electrodynamics, whose referents are well-known from human experience, quantum mechanics deals with phenomena that are quite apart from common sense. One consequence of this was that the semantical interpretation of the mathematical formalism of the theory was not even clear to those who developed this very formalism. This incompleteness was aggravated by the unusual character of many quantum phenomena revealed by the experiments and correctly predicted by the theory. Philosophers and physicists alike started soon to associate quantum mechanics with all kind of propositions, from the non-existence of reality to the existence of infinite worlds. Bohr, the main advocate of the standard interpretation (known as the Copenhagen interpretation), for instance, claimed that reality was not a property of the referents of quantum theory (neither of the physicists that formulated the theory, including himself):

An independent reality, in the ordinary physical sense, can neither be ascribed to the phenomena nor to the agencies of observation.¹

Heisenberg, among other things, held that materialism is untenable because quantum mechanics shows that it lacks of object:

The ontology of materialism rested upon the illusion that the kind of existence, the direct “actuality” of the world around us, can be extrapolated into the atomic range. This extrapolation is impossible, however.²

Another well-known quantum physicist, Eugene Wigner, maintained that consciousness is a necessary ingredient of the theory:

It is not possible to formulate the laws of quantum mechanics in a fully consistent way without reference to the consciousness.³

Wigner went as far as to vindicate a kind of “quantum solipsism” (see Wigner 1995). Examples as these can be multiplied endlessly with the result that many physicists despair when the discussion swifts to the deep meaning of quantum mechanics. Most of them simply prefer just to use the mathematical apparatus of the theory to make quantitative predictions without further questioning. Richard Feynman put it clearly in this way:

On the other hand, I think I can safely say that nobody understands quantum mechanics. So do not take the lecture too seriously, feeling that you really have to understand in terms of

¹ Bohr (1987), p. 54.

² Heisenberg (1962), p. 145.

³ Wigner (1995), p. 248.

some model what I am going to describe, but just relax and enjoy it. I am going to tell you what nature behaves like. If you will simply admit that maybe she does behave like this, you will find her a delightful, entrancing thing. Do not keep saying to yourself, if you can possibly avoid it, 'But how can it be like that?' because you will get 'down the drain', into a blind alley from which nobody has yet escaped. Nobody knows how it can be like that.⁴

And yet we ultimately do science not because we want to calculate, but because we want to understand. And in the case of quantum mechanics we want to understand what this strange theory is about and what it does mean. Should we really reject materialism if we accept quantum mechanics? Minds can act upon microphysical systems? Is realism affected in any sensible way in the quantum picture of the world? Can truly quantum objects be both particles and waves? What is, after all, the ontology of the world according to quantum mechanics?

In this chapter I want to answer these questions. I am well aware that many people has done this before, in disparate ways and with disparate results. I do not want to add confusion to a confuse subject. My approach will be to stay close to the formalism, and to apply the tools of modern semantics to the analysis of this formalism. I will pay attention not to what scientists say, but to what they do when they research. The view that will emerge will be one that is in full agreement with a materialist conception of the world. Quantum mechanics is strange, surely, but it is so because reality is strange to us, not because it doesn't exist or because it is immaterial.

4.2 The Peculiarities of Quantum Systems

Perhaps the best way to get a first glimpse of the strangeness of the quantum phenomena is through the double slit experiment. Let us consider a screen with two slits. Thomas Young used a screen like this and a background screen to demonstrate the wave character of light in 1801. If we send a beam of monochromatic light to the first screen, each slit becomes a coherent light source that then interferes constructively or destructively with the other. The result in the background screen is the formation of an interference pattern that reveals the wave nature of light (see the left side of Fig. 4.1). If we send, instead, particles against the screen with the slits, some of them will bounce off the screen, but some will travel through the slits. These latter particles will travel to the second screen where they will impact producing two strips of marks with roughly the same shape as the slits (Fig. 4.1, middle image). This effect shows that what we throw through the slits were particles. All this sounds familiar to our experience. Let us now repeat the experiment using very narrow slits and throwing electrons. If we block one of the slits off for the moment, we will find that some of the electrons will pass through the open slit and strike the second screen just as particles would: the image on the screen will form a strip roughly of the same shape as the slit.

⁴ Feynman (1965), p. 129.

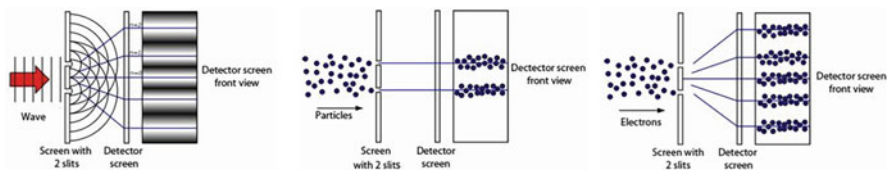

Fig. 4.1 Double slit experiment. On the left a wave goes through a screen with two slits and produce an interference pattern on the detector. In the middle, classical particles are shot through the slits making impact on two points on the background screen. Finally, on the right, electrons are thrown to the two-slit screen. The result is an interference pattern as in the first case. But if a detector is located in one of the slits, a discrete event is register. The electron seems to behave both as a wave or as a particle according to the experimental array

Let us now open the second slit. If you expect two rectangular strips on the second screen, you are wrong. What you will actually see is that the spots where the electrons hit build up to replicate the interference pattern from a wave. Exactly as it was the case with light. How can this be? Perhaps, you might think, the electrons somehow interfere with each other, so they do not arrive in the same places they would if they were alone. Experiments show, however, that the interference pattern remains even when the electrons are fired one by one, so that they have no chance of interfering. Each individual electron contributes one dot to an overall pattern that looks like the interference pattern of a wave. Quite strange. Is the electron a wave or a particle? Maybe each electron somehow splits, passes through both slits at once, interferes with itself, and then recombines to meet the second screen as a single, localized particle?

One way to find out, is to place a detector in the slits, to report which slit an electron passes through. If you do that, then the pattern on the detector screen turns into the particle pattern of two strips, as seen in the middle image of Fig. 4.1. The interference pattern disappears! Somehow, the conditions in the slit make the electrons to travel like classical particles. Some people interpretes this as an effect of our act of ‘seeing’ the electron. Other people say that it is the act of measuring what creates the result of the experiment.

What seems to be for sure is that what we call ‘particles’, objects such as electrons and photons, somehow combine characteristics of classical particles and characteristics classical of waves. This is the famous wave particle duality of quantum mechanics. It also suggests that the conditions of the experiment have a deep effect on the quantum system. The question of exactly how that happens constitutes the core of the so-called measurement problem of quantum mechanics.⁵

Let us now consider another weirdness proper of the quantum world: entanglement. In 1935, Einstein noticed that since the dynamical equations of quantum

⁵ The problem of measurement might be enunciated more precisely saying that quantum systems evolve in a superposition of states before a measurement. The measurement, however, always reveals a definite particular state. See the end of Sect. 4.3.

mechanics are linear, the so-called principle of superposition holds: the linear combination of solutions is also a solution. Einstein, and two of his assistants, Boris Podolsky and Nathan Rosen, showed in a famous paper (Einstein et al. 1935) that when those equations are applied to a system of two interacting particles that are then set apart, some strange effects appear. Let us imagine, for simplicity, a source of unpolarized photons. Photons admit two different states of polarization. If a pair of photons are emitted from the source their common state will be one of zero polarization. However, individual photons must have some state of polarization. Let us assume that some detector measures the polarization of one of the photons and it results in a given value. Then the other photon, it doesn't matter how distant it is, even if it is beyond causal reach, shows exactly the opposite polarization in such a way that the total polarization of the pair remains zero. They are somehow linked, despite the distance. The situation is illustrated in Fig. 4.2.

This strange correlation, not observed in the macroscopic world, is called *entanglement*. Einstein thought that such a “spooky action at distance” was actually showing that quantum mechanics was an incomplete theory. In other words, that the theory must have hidden variables. However, a theorem due to Bell (1964, 1966) rules out local theories that have hidden variables. A class of experiments was devised to test Bell's theorem. Experiments of this type were first implemented

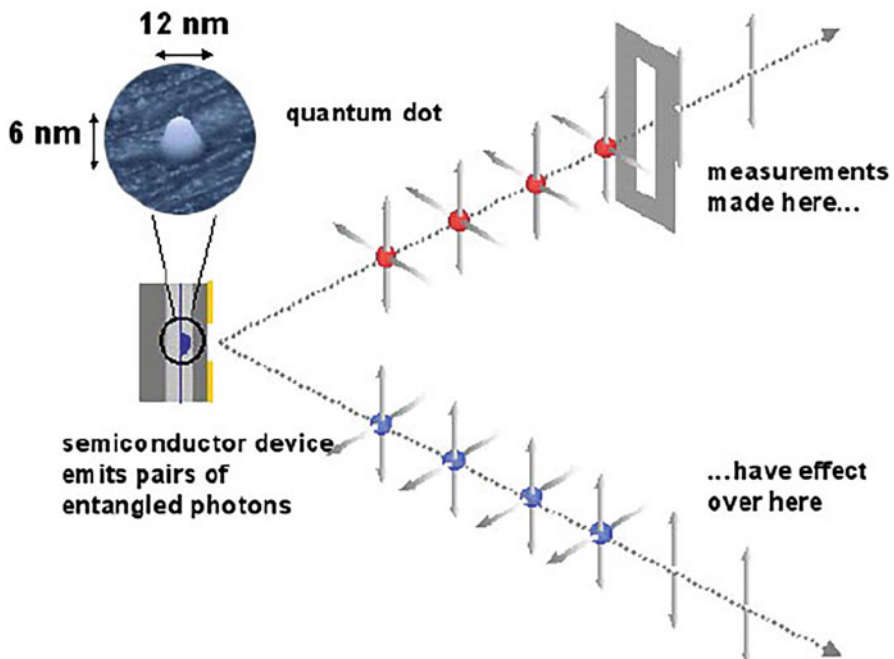

Fig. 4.2 Entanglement. Two photons are prepared in such a way that their individual states remain correlated even on space-like separations. These correlations are non-local and apparently instantaneous

by Freedman and Clauser (1972) and Aspect et al. (1981, 1982). Since then, many of such experiments have been performed. In all cases their results are in complete agreement with quantum mechanics. There are not hidden variables in the theory. Quantum objects seem to have non-local properties, in the sense that they are correlated independently of the distance. Quantum physics cannot be represented by any version of the classical picture of the world.

4.3 The Formalism of Quantum Mechanics

If we want to get some insight into the meaning of quantum mechanics, first we need to have a look at its formalism. Theories are hypothetical–deductive systems of statements closed under the operation of entailment (e.g. Bunge 1967). But only mature theories are cast into axiomatic format. Most of them are presented as collections of statements, dynamic equations, assumptions, and collateral observations. All this tends to create an opacity of meaning, especially when the formalism is complex and the referents elusive, as in the case of quantum mechanics. Rigorous axiomatizations of the theory exist (e.g. Bunge 1967; Perez Bergliaffa et al. 1993, 1996; Romero 2018). Here I shall just show the basic elements of the theory in order to guide the reader through the interpretation. Details can be found in the mentioned papers and books.

The referents of quantum mechanics are physical systems called *quantum systems*. The states of a quantum system are represented by a non-unique, normalized, mathematical function $\psi(\bar{x}) \in \mathcal{H}$ called *wave function*, where \bar{x} denotes the position of a point in Euclidean 3-dimensional space, and \mathcal{H} stands for a Hilbert space.⁶ The wave function is a fundamental mathematical tool for calculating the values of the different properties of the quantum system, but it should not be confused with the quantum system itself.

Unlike classical theories, quantum states are represented by complex functions in Hilbert space, where a summation operation is defined. This fact, and the already mentioned linearity of the dynamic equations of quantum mechanics, imply that the Principle of Superposition holds at the level of states. Many other theories have dynamical equations that are linear; for instance, Maxwell's equations for electrodynamics are linear. However, quantum mechanics is unique in the feature that the dynamical equations refer to *states* of systems, and not merely to properties such as the intensities or densities of fields. Although the wave function refers to the quantum system, it does not directly represent it. Being a complex function, it cannot represent real entities.

⁶ A Hilbert space is an abstract vector space possessing the structure of an inner product that allows lengths and angles to be measured. Hilbert spaces are complete in the sense that there are enough limits in the space to allow the techniques of calculus to be used.

The *inner product*⁷ of two states is defined by:

$$\langle \psi | \phi \rangle = \int d\bar{x} \psi^*(\bar{x}) \cdot \phi(\bar{x}). \quad (4.1)$$

The values of the *properties* of a quantum system can be calculated with self-adjoint operators $\hat{A}(t) : \mathcal{H} \rightarrow \mathcal{H}$, acting upon the corresponding wave functions. Unlike classical systems, quantum systems may not have precise or sharp values for their properties. Instead, we can calculate the average $\langle \hat{A} \rangle$ of a certain property of a system in a given state ψ by:

$$\langle \hat{A} \rangle = \langle \psi | \hat{A} | \psi \rangle. \quad (4.2)$$

The spread $\Delta_\psi \hat{A}$ of the average is

$$\Delta_\psi \hat{A}^2 = \langle \hat{A}^2 \rangle - \langle \hat{A} \rangle^2. \quad (4.3)$$

If the spread $\Delta_\psi \hat{A}$ of a certain property of a quantum state $\psi_k(\bar{x})$ is null, then the property takes a sharp value λ_k . The corresponding state $\psi_k(\bar{x})$ is called an eigenstate of the operator \hat{A} , λ_k is its eigenvalue, and they satisfy:

$$\hat{A} \psi_k(\bar{x}) = \lambda_k \psi_k(\bar{x}). \quad (4.4)$$

Under certain conditions, the values λ_k may constitute a countable set, i.e. the values of the property may be quantized. This is another specific feature of quantum systems. Actually, the term ‘quantum’ is derived from this feature of having discrete values of some properties.

Because of the Superposition Principle, quantum states are not exclusive. Given an eigenstate $\psi_k(\bar{x})$ of certain self-adjoint operator $\hat{A}(t)$, the propensity of any quantum system in a state $\psi(\bar{x})$ to take the value λ_k is quantified by a probability p_k given by:

$$p_k = |\langle \psi | \psi_k \rangle|^2, \quad (4.5)$$

where $0 < p_k < 1$.

Quantum mechanics has an evolution equation that describes how properties change with time. The equation reads:

$$\frac{d\hat{A}}{dt} = \frac{i}{\hbar} (\hat{H} \hat{A} - \hat{A} \hat{H}) + \frac{\partial \hat{A}}{\partial t}, \quad (4.6)$$

⁷ In this definition the symbol * designates the conjugate-complex of the wave function.

where \hat{H} denotes a particular operator called Hamiltonian of the system and \hbar is the Planck constant over 2π . The Hamiltonian represents the energy of the system. This dynamical equation is called Heisenberg's equation. Notice that if the system is not interacting $\hat{H} \neq \hat{H}(t)$ and the evolution of any property is given by:

$$\hat{U}(t, t_0) = \exp -\frac{i}{\hbar} \hat{H}(t - t_0), \quad (4.7)$$

where the evolution operator is clearly unitary:

$$\hat{U}(t, t_0) \hat{U}(t, t_0)^\dagger = \hat{I}. \quad (4.8)$$

An alternative, equivalent, formulation of the theory can be obtained adopting time-independent operators to represent the properties and a time-dependent wave function $\psi(x) = \psi(\bar{x}, t)$ that obeys the Schrödinger's equation:

$$\hat{H}\psi(x) = \frac{i}{\hbar} \frac{\partial \psi(x)}{\partial t}. \quad (4.9)$$

The two pictures only differ by a basis change with respect to time-dependency, which corresponds to the difference between active and passive transformations. The equivalence was proved by Schrödinger (1926) and Eckart (1926).

One immediate consequence of the dynamical equations (4.6) and (4.9) is that the evolution of the system is fully deterministic (see Earman 1986 for a full discussion of determinism in quantum mechanics): if we know the state of the system at the instant t_0 then we know the state of the system at any instant t . Every property evolves as:

$$\hat{A}(t) = \hat{U}(t, t_0)^\dagger \hat{A}(t_0) \hat{U}(t, t_0), \quad (4.10)$$

and the state evolves as:

$$\psi(x) = \hat{U}(t, t_0) \psi(x_0). \quad (4.11)$$

This fact is cause of much confusion. If the state $\psi(x)$, according to the Principle of Superposition, is a combination of states, then $\psi(x) = \sum_k \lambda_k \psi_k(x)$, where λ_k is a set of eigenvalues of some operator \hat{A} and the ψ_k are the corresponding eigenstates that form a complete basis of the Hilbert space. As far as the system evolves unitarily, it is in a mixture of states. The prediction of quantum mechanics is that the probability of the system of being in a particular state ψ_n with a value λ_n under some specific boundary conditions is given by Eq. (4.5). When an effective measurement is done, the system is found in some definite or pure state with some actual value for the property represented by \hat{A} . It seems that the system is now in a state ψ_h , and remains there unless it is acted upon. How is possible for the quantum system to break unitary evolution and change its state? This is, again, the problem of

measurement, now expressed in technical terms. And here is, perhaps, where most interpretational misunderstandings of the theory begin.

4.4 Interpretation

Quantum mechanics is a deterministic theory that makes probabilistic predictions. Such probabilities quantify the propensity of the quantum systems to go from a state described by $\psi(x)$ to an eigenstate $\psi_k(x)$. Before implementing a measurement (or more generally, before undergoing an interaction with the environment), the system has a propensity with a probability $|\langle\psi|\psi_k\rangle|^2$ to be found in a state $\psi_k(x)$ where a given property \mathcal{A} , represented by the operator \hat{A} , has a definite value λ_k . Unless the original state is already $\psi_k(x)$, this probability is smaller than 1. If, after the measurement or the interaction, the system is found to have a value for \mathcal{A} of λ_k , the probability of a subsequent measurement of finding such a value is now 1. So it seems that there was a sudden change in the state of the system from $\psi(x)$ to $\psi_k(x)$. The system apparently experienced an irreversible transition from a mixed to a pure state, violating unitary evolution. Heisenberg expresses the situation in this way:

Since through the observation our knowledge of the system has changed discontinuously, its mathematical representation also has undergone the discontinuous change and we speak of a ‘quantum jump’.⁸

This statement seems to attribute the transition to the observation. To solve this problem, von Neumann introduced the famous postulate of the collapse of the wave function:

If the measurement of a physical observable A (with associated operator \hat{A}) on a quantum system in the state ψ gives a real value a_n , then, immediately after the measurement, the system evolves from the state ψ_n , where $\hat{A}\psi_n = a_n\psi_n$.⁹

This postulate interprets the collapse of the wave function as a consequence of the act of measuring the property \mathcal{A} . To fix the state of the system in a sharp value for the property in question requires, accordingly, the intervention of ‘an observer’, or at least of a measurement device. This seems to suggest that the exact form of reality is dependent on our observations of it. From here to idealism there is just a small step:

It is not a mysterious interaction between the apparatus and the object that produces a new ψ for the system during the measurement. It is only the consciousness of an ‘I’ who can separate himself from the former function $\psi(x, y, z)$ and, by virtue of his observation, *set up a new objectivity* in attributing to the object henceforward a new function $\psi(x) = \psi_k(x)$.¹⁰

⁸ Heisenberg (1958), p. 28.

⁹ von Neumann (1955) (original 1932).

¹⁰ London and Bauer (1939), p. 252.

The intrusion of ‘the observer’ is also frequently invoked as the origin of the so-called ‘Heisenberg’s uncertainty relations’:

$$\Delta \hat{x}_i \Delta \hat{p}_i \geq \hbar/2, \quad (4.12)$$

$$\Delta E \Delta t \geq \hbar/2, \quad (4.13)$$

where the operators represent components on the same direction of the position and linear momentum of the system, E is the energy, and t is the time.

The situation can be clarified through the investigation of the semantical assumptions of the theory. A way to approach this problem is casting the theory into an axiomatic format. In such a format not only the formal and nomological assumptions are made explicit, but also those that link formal constructs with extra-linguistic objects (see Bunge 1967, 1973, 1974; Perez Bergliaffa et al. 1993, 1996; Romero 2018). When this is done, several issues become evident. First, the direct referents of the theory are quantum systems and their environments, not observers or instruments, much less minds or conscious states. Second, the theory can be used (by imposing boundary conditions, which represent specific situations, to the dynamic equations) to predict the probability of some event to occur. This probability is the quantitative estimate of the propensity of the system to have a given value of a certain property under those conditions; it is calculated through the rule expressed by Eq. (4.5). If the system is effectively found through an experiment to have such a property, it means that its state evolved from a state described by ψ to a state that corresponds to the measured value, say, ψ_k . A new determination of the same or of another property of the same system will correspond to one obtained from the new state ψ_k . The probability has not “collapsed” after the measurement from the initially predicted value to a value $p_k = 1$. The a priori probability remains the same, exactly as the a priori probability before a roll of dice does not change or collapse when the dice finds a final state. This interpretation of the theory remains silent about how the evolution of the state occurs. From the reference class, it is clear that the only thing that can affect the state is the interaction with the environment. It is this environment which is responsible for the evolution. Such evolution does not obey the linear equations (4.6) and (4.9). The full description of the process depends on the details of the interaction and is not a part of the original quantum theory but the core of the quantum theory of measurement, which rests on the concept of decoherence (see Schlosshauer 2007). A general theory of quantum measurement does not exist, and it is dubious whether it can be consistently formulated in all generality since it should depend on the specific experimental device.

A third important point that becomes clear from an axiomatization of the quantum theory is that the Heisenberg inequalities are theorems and have nothing to do with the effect of any observer. They can be derived from the non-commutation of the corresponding operators and the so-called Schwartz inequality, that is purely mathematical (Bunge 1967; Perez Bergliaffa et al. 1993). Since there is no time

operator in quantum mechanics, the fourth inequality (4.13) does not strictly hold. Instead, the correct expression is:

$$\Delta \hat{H} \tau_A \geq \frac{\hbar}{2}$$

with $\tau_A = \Delta \hat{A} / |d \langle \hat{A} \rangle / dt|$. Here \hat{A} is any time-dependent operator (see Bunge 1977 and Messiah 2014). All these inequalities represent actual relations among the properties of quantum systems. They have nothing to do with our knowledge, uncertainty, or our observations. They just say that some quantum properties are not defined simultaneously in a sharp way. Such properties are not classical properties, but *sui generis* properties of quantum systems.

Another issue that is illuminated by an analysis of the semantic structure of the theory when it is exposed through an axiomatization is the fact that neither realism nor materialism are ruled out by quantum entanglement. The experimental refutation of Bell's inequalities that demonstrate the reality of entanglement just expresses that (1) theories with hidden variables are false (i.e. quantum mechanics is complete) or (2) the theory is non-local or (3) both (1) and (2) are true. Non-locality is a feature of reality according to quantum mechanics if the theory is complete. This is far cry from stating that there is no reality. Reality might be strange to our common sense, but this does not mean lack of reality or idealism. Entanglement neither seems to violate causality. Causality is relation among events, not among things. A causal action of a thing A upon a thing X is just a way to say that an event in thing A triggers an event in thing B. Causality implies a change of the state of a particular entity. This seems not to be the case with quantum entanglement: when we determined the state of one of the components of the entangled system, there is no change in the state of the other component. The state of this component does not go, say, from state s_1 to state s_2 . There is simply a *specification* of the state of the system: of the different states in which the system might be, it always occurs that the state is that corresponding to the initial preparation of the system. Since there is no work exerted on the second component, no energy transfer occurs (the energy of the component is exactly the same before and after the specification of its state). There is no causal connection between components at all; there are just non-local correlations: once an entangled state has been formed, the system remains intertwined regardless of the spatial separation of the components. When we specify the state of the first component of an entangled pair, the state of the second component is specified as well according to the initial preparation of system. Once an interaction has destroyed the interlacing, the components are separated and there are no more correlations. In this view, there is no action of one component of the system upon the other; there are just non-local correlations. Once the system is formed, some properties remain until some interaction destroys the entanglement (López and Romero 2017). It is because of no actual work is done that information cannot be transmitted faster than light through entanglement. Any transmission of information requires a signal that should move, at most, at the speed of light (see Romero 2018 for a discussion of the concept of semantic information).

Summing up, we can say that quantum mechanics admits a perfectly consistent interpretation that is realist because quantum systems are considered real entities endowed with properties existing in spacetime.¹¹ This interpretation is also objective, since there is no inclusion of observers or subjects in the formalism. The kind of reality revealed by quantum mechanics is non-local and certainly very removed from the usual intuitions based on the common sense, but the kind of entities that populate the quantum world seem to be entirely material. . . or do not?

4.5 Quantum Field Theory

The interpretation of quantum mechanics offered in the previous section implies that quantum systems are objective real entities with specific properties that manifest as propensities. They are neither particles nor waves, but *sui generis* objects that under some conditions behave like classical particles and under other conditions are similar to waves. Classical analogies of some of their properties cannot even be sharply defined simultaneously. Other properties, such as entanglement or spin, are exclusive of the quantum realm and do not have classical analogues.

This ontology is better understood if we conceive quantum systems as fields. The idea of fields was introduced by Faraday in the nineteenth century and was successfully applied to the electromagnetic field by Lorentz and others. Quantum field theory was the natural result of trying to accommodate the concept of electromagnetic field to the demands of quantum mechanics. The result, quantum electrodynamics, is a robust theory of extraordinary predictive power. Based on the success of this theory, the field approach was applied to weak and strong interactions, eventually leading to the standard model of current physics. This model presents a unified field view of all interactions (except gravity). Each field is an extended entity existing on spacetime. Particles are not anymore autonomous things but features of the field. Although they are countable, they are not distinguishable. Particles are just discrete excitations of the fundamental state of the field. All fields exist independently of whether they are excited or not. The fundamental level, when no excitation is present, is called the ‘vacuum state’. This state should not be

¹¹ This is not the only realist and objective interpretation that can be proposed for quantum mechanics. The Many-Worlds interpretation, for instance, adopts the collapse postulate and interprets it at face value accepting an ontological inflation. The overabundant ontology that results is perfectly compatible with materialistic views. This article is not the place to discuss the different arguments for and against these and other interpretations. Rather, the point to be emphasized here is the fact that quantum mechanics can be consistently understood in a way such that the theory does not imply a challenge for materialism. For discussions about interpretations of quantum mechanics see Ruetche (2011) and Acuña (2019).

confused with actual vacuum or absence of field. It has properties, such as energy fluctuations and is susceptible of polarization.

The vacuum state $|0\rangle$ can be excited to form a so-called Fock basis of the quantized field:

$$|1_k\rangle = \hat{a}_k^\dagger |0\rangle. \quad (4.14)$$

Each application of the operator \hat{a}_k^\dagger adds one quantum excitation to the state k . It represents any physical process that produce such excitations. Successive applications of the operator \hat{a}_k^\dagger yield:

$$\hat{a}_k^\dagger |n_k\rangle = (n+1)^{1/2} |(n+1)_k\rangle. \quad (4.15)$$

Similarly, the operator \hat{a}_k removes quanta:

$$\hat{a}_k |n_k\rangle = n^{1/2} |(n-1)_k\rangle. \quad (4.16)$$

The operator \hat{a}_k can be used to define the vacuum state as the state for which

$$\hat{a}_k |0\rangle = |0_k\rangle, \quad \forall k. \quad (4.17)$$

In this way, any system of n particles is understood as a fundamental quantum field with n excitations of the vacuum. The vectors $|n_1, n_2, \dots, n_k\rangle$, where n_i is the number of quanta in the state i , belong to the separable Hilbert space which is the tensor sum of a countable number of Hilbert spaces \mathcal{H}_j , where the subscript j also corresponds to the number of (non-interacting¹²) particles present, namely, $\mathcal{H}_1 \oplus \mathcal{H}_2 \oplus \dots \oplus \mathcal{H}_n$. Here \oplus indicates the direct sum. The operators \hat{a}_i^\dagger and \hat{a}_j obey the operator algebra given by:

$$[\hat{a}_i, \hat{a}_j^\dagger] = \delta_{ij}, \quad (4.18)$$

$$[\hat{a}_i^\dagger, \hat{a}_j^\dagger] = 0, \quad (4.19)$$

$$[\hat{a}_i, \hat{a}_j] = 0. \quad (4.20)$$

¹² For interacting particles the tensor product should be considered.

In the case of fermions, where only one excitation is possible in each state, the operator algebra becomes:

$$[\hat{a}_i, \hat{a}_j^\dagger]_+ = \delta_{ij}, \quad (4.21)$$

$$[\hat{a}_i^\dagger, \hat{a}_j^\dagger]_+ = 0, \quad (4.22)$$

$$[\hat{a}_i, \hat{a}_j]_+ = 0, \quad (4.23)$$

where the subscript $+$ stands for anti-commutation: $[A, B]_+ = AB + BA$.

In Minkowski space, a preferred basis can be constructed using the specific symmetries of this space (the Poincaré group). Then, if $\hat{N}_k = \hat{a}_k^\dagger \hat{a}_k$ is the operator number of particles, we get

$$\langle 0 | \hat{N}_k | 0 \rangle = 0, \quad \text{for all } k. \quad (4.24)$$

This means that the expectation value for all quantum modes of the vacuum is zero: if there are no particles associated with the vacuum state in one (non-accelerated) reference system, then the same is valid in all of them. In curve spacetime this is not valid any longer: general spaces do not share the Minkowski symmetries, and hence the number of particles is not a relativistic invariant. This reflects the fact that particles are features of the field and not independent entities. What exists cannot depend on the description offered in a particular frame, as it happens with the number of quanta.

Since in general spacetimes there are different complete sets of modes for the decomposition of the field, a new vacuum state can be defined:

$$\hat{a}_j |\bar{0}\rangle = |0\rangle, \quad \forall j, \quad (4.25)$$

and from here a new Fock space can be constructed. The field $\phi(x)$ can be expanded in any of the two basis:¹³

$$\phi(x) = \sum_i [\hat{a}_i u_i(x) + \hat{a}_i^\dagger u_i^*(x)], \quad (4.26)$$

and

$$\phi(x) = \sum_j [\hat{a}_j \bar{u}_j(x) + \hat{a}_j^\dagger \bar{u}_j^*(x)]. \quad (4.27)$$

¹³ For simplicity I consider here a scalar field.

Since both expansions are complete, we can express the modes \bar{u}_j in terms of the modes u_i :

$$\bar{u}_j = \sum_i (\alpha_{ji} u_i + \beta_{ji} u_i^*), \quad (4.28)$$

and conversely,

$$u_i = \sum_j (\alpha_{ji}^+ \bar{u}_j - \beta_{ji} \bar{u}_i^*). \quad (4.29)$$

The coefficients α_{ij} and β_{ij} satisfy the relations

$$\sum_k (\alpha_{ik} \alpha_{jk}^* - \beta_{ik} \beta_{jk}^*) = \delta_{ij}, \quad (4.30)$$

$$\sum_k (\alpha_{ik} \beta_{jk} - \beta_{ik} \alpha_{jk}) = 0. \quad (4.31)$$

The operators on the Fock space then can be represented by:

$$\hat{a}_i = \sum_j (\alpha_{ji} \hat{a}_j + \beta_{ji}^+ \hat{a}_j^\dagger), \quad (4.32)$$

and

$$\hat{a}_i^\dagger = \sum_j (\alpha_{ji}^* \hat{a}_i - \beta_{ji}^* \hat{a}_i^\dagger). \quad (4.33)$$

An immediate consequence is that

$$\hat{a}_i |\bar{0}\rangle = \sum_j \beta_{ji}^* |\bar{1}_j\rangle. \quad (4.34)$$

Since in general $\beta_{ij} \neq 0$, the expectation value of the operator \hat{N}_i is:

$$\langle \bar{0} | \hat{N}_i | \bar{0} \rangle = \sum_j |\beta_{ij}|^2 \neq 0. \quad (4.35)$$

This surprising result means that the number of quanta of the field (particles) is different for different decompositions. Since different decompositions correspond to different choices of reference frames, we must conclude that different observers detect a different number of quanta (particles). These particles activate detectors in some reference systems, but not in others. They are essentially a frame-dependent feature of the field. If we accept that whatever exists objectively cannot depend on

our choice of a particular reference system, then the assumption that particles are self-subsistent individuals falls apart.

In quantum field theory particles are not dealt with as individuals but as features of the quantum fields and relative to some specific choice of mode decomposition of the field that is frame-dependent. Matters of existence should not be solved just counting or individuating with respect to some reference system, but considering true invariant properties and their referents. In this sense it is the energy-momentum complex and its mathematical representation through a second-rank tensor field $T_{\mu\nu}$ that provides an objective indicator of independent existence. Contrary to the excitations of the field, that depend on global modes defined over the whole spacetime, the energy-momentum of the field is defined locally through a tensor quantity. For a fixed state $|\psi\rangle$ the results of different detectors when measuring the expectation value $\langle\psi|\hat{T}_{\mu\nu}|\psi\rangle$ can be related by the usual transformation laws of tensors. In particular, if $\langle\psi|\hat{T}_{\mu\nu}|\psi\rangle = 0$ in one reference system, the energy density of the quantum field will be zero for any reference frame. This situation is quite different for particles, that might be detectable or not in the same region of space by different observers in different states. This clearly points out that the ontological import is in the quantum field, not in the particles. And it is not neither in the structure, since the structure emerges from the relations of the fields.

It might be objected that in the case of Minkowski spacetime all fields are in the vacuum state and then $\langle 0_M|\hat{T}_{\mu\nu}|0_M\rangle = 0$. But an accelerated observer in this spacetime actually should detect thermal radiation (Davies 1975; Unruh 1976). In the accelerated frame it is also valid $\langle 0_M|\hat{T}_{\mu\nu}^{\text{acc}}|0_M\rangle = 0$, so the thermal radiation seems to violate energy conservation. But this is a wrong conclusion originated by considering only a part of the system. The whole system is the accelerated detector plus the field in the vacuum state. The field couples with the accelerated system producing a resistance against the accelerating force. It is the work of the external force that produces the thermal bath measured by the detector in the co-moving system. The same radiation is not measured by a detector at rest, since it is not coupled with the field. I remind here that a vacuum state of the field does not correspond to the absence of field, but to the absence of discrete excitations of the field. The example just shows the reality of the field, even when there are no excitations. The excitations themselves, the quanta, can be present in one system and not in other, according to the state of the system with respect to the field.

When curvature is present in spacetime, inertial frames are associated with free-falling systems and in general not unique choice of the vacuum state can be made to express the field, as we have seen above. So, different detectors located in different reference systems will detect different numbers of particles. Polarization of the vacuum by event horizons results in Hawking radiation that is detectable in the asymptotically flat region of spacetime, but such radiation is not seen by an observer falling freely into the black hole. In general, there is not simple relation between $\langle\hat{N}_i\rangle$ and the particle number measured by different detectors (Birrell and Davies 1982). The ontological status of particles in quantum field theory in curve spacetime is that of a complex relational property between fields and detectors (reference

frames). The ontological substratum, however, is provided by the fields. Remove them, and nothing is left: no energy-momentum, no excitations, no expectations, no structure. I conclude that quantum objects are quantum fields over spacetime.

4.6 Quantum Ontology

If we accept the ontological principle that what there is cannot depend on our way to describe it, we are led to reject particles (quantum excitations of the field) as basic ontological entities. This point has been emphasized by Davies (1984) and Hobson (2013). The absence of particles that corresponds to a vacuum state defined by Eq.(4.17) is not universal. Even in Minkowski (flat) spacetime, this relation does not define a global vacuum since excitations are seen by accelerated observers (Unruh 1976). The vacuum in Minkowski spacetime is shared by all observers in *inertial frames* because of this spacetime is symmetric under the group of Poincaré transformations. But detectors in accelerated frames, as we already saw, will measure a flux of particles and for them the vacuum will be a different state. Particles, being excitations of the field, are frame-dependent.

If we want to probe the ontological substratum of the excitation, i.e. the field itself, we need to turn to *locally well-defined* properties, such as the energy and momentum that are represented by the expectation value of the energy-momentum tensor: $\langle 0|\hat{T}_{\mu\nu}|0\rangle$. If $\langle 0|\hat{T}_{\mu\nu}|0\rangle = 0$ in one reference system, then it will remain zero in the entire spacetime. Energy is relativistically invariant because what exists, exists in all reference frames. The group of symmetries of general relativity is the set of *all* frame transformations.

The energy-density of any field in any point of spacetime is well-defined through $\langle |\hat{T}_{\mu\nu}| \rangle$.¹⁴ If we understand as material entities those capable of changing, this implies that the quantum fields are the true material constituents of the world because energy is just the capability of changing. Any field can change and do work, i.e. induce changes, in some potential detector.

I conclude that quantum ontology is an ontology of fields, not of particles or waves. Much less of minds, worlds, or observers. We live in a world of fields and we are nothing but a complex system of excitations of such fields. How many fields are there, exactly? So far we only know the fields of the standard model of quantum field theory. These are 12 fundamental fields for fermions (6 quarks and 6 leptons) and 13 fundamental fields for bosons (8 gluons; 3 for W_+ , W_- and Z_0 bosons; 1 for the photon and 1 for the recently discovered Higgs boson). All these fields exist on a background spacetime.

¹⁴ All theories discussed here are renormalizable.

4.7 Quantum Matter and the Stuff of the World

Let us assume that the line interval of spacetime is given by a pseudo-Riemannian metric $g_{\mu\nu}(x)$:

$$ds^2 = g_{\mu\nu}(x)dx^\mu dx^\nu. \quad (4.36)$$

Einstein's field equations relate the metric structure of spacetime with the energy content of the fields defined on it:

$$R_{\mu\nu} - \frac{1}{2}Rg_{\mu\nu} = \frac{8\pi G}{c^4}\langle\hat{T}_{\mu\nu}\rangle. \quad (4.37)$$

As we have seen, the fields represented on the right side of these equations are material, since $\langle\hat{T}_{\mu\nu}\rangle$ is well-defined, or can be renormalized to a well-defined quantity. But what about the left side of the equations? Is spacetime material? The answer seems to be 'yes, it is' (see the chapter by L. Combi in this volume). First, any perturbation of the fields produces a perturbation in spacetime. Such perturbations can travel even in the absence of any other field at the speed of light. They are changes in the curvature of spacetime. Such curvature should be interpreted as a physical property, not a purely geometrical one. This becomes clear when we realize that curvature changes produce changing tidal forces that can exert work and transfer energy to other material things. Second, global dynamical solutions of the equations exist. In models of universes represented by such solutions, spacetime can do work upon material systems through cosmological forces, clearly showing that spacetime is material as well (see Romero 2017 for further arguments).

If spacetime is material we can ask whether it is another quantum field. Certainly it is not the same kind of field as the quantum fields we have been discussing so far. All known fields are defined *on* spacetime, and cannot exist without it. Without spacetime, the energy-momentum of any field cannot be formulated because the metric is essential to it:

$$T_{\mu\nu} = \frac{2}{\sqrt{-g}} \frac{\delta\mathcal{L}_M}{\delta g^{\mu\nu}}, \quad (4.38)$$

where $g = ||g^{\mu\nu}||$ is the determinant of the metric tensor, and \mathcal{L}_M is the effective Lagrangian density of the material fields other than gravitation. Clearly, without $g_{\mu\nu}$ there is not $T_{\mu\nu}$. The converse is not true: we can have spacetime without any quantum field, as indicated by vacuum solutions of Eqs. (4.37). We express this fact saying that spacetime is background independent.

At this point, if we are asked what is the stuff of the world, we might answer with the title of a famous book by Hermann Weyl: space, time, matter. Or better, material spacetime and material quantum fields. Matter, then, seems to come in two flavors: spacetime and quantum fields. Each of them is material because each of them has energy and can act upon the other. But they appear to be different in the

sense that spacetime looks more independent and fundamental than quantum fields. The latter, we might say, are parasitic of the former. In addition, energy is not a well-localized property in spacetime. Any region of spacetime is locally flat, and energy is associated with curvature. Hence, it can be only attributed in a covariant sense to a region of spacetime, never to a point.

The description of spacetime given by general relativity, however, is far from satisfactory: many physically realistic models are singular, i.e. they give an incomplete description of spacetime (see Romero 2013). Simple examples are the hot big-bang model and black hole models. This fact has led to many different approaches of formulating a quantum theory of spacetime (and hence of gravity, which is a consequence of spacetime curvature). The direct attempt of considering the metric field as a classical field and to apply the standard quantification methods leads to non-renormalizable theories. A wide variety of different ways to circumvent this have been attempted (see, e.g. Oriti 2009). The crucial questions are about the nature of spacetime itself: has spacetime quantum properties? How such properties should be understood if they are not expressed in terms of spacetime itself? Attempts to answer such questions can be seen as the search for a conceptual unification of all forms of matter. A different path, followed by Einstein and Wheeler, was to consider spacetime as the basic entity, and then proceed to derive all other physical entities from it. Again, this is an attempt to unify the different types of matter. Both ways have problems and it is not even clear whether they can be formulated consistently. An intermediate approach is to look for a prior substratum, from where *both* spacetime and fields would emerge in the appropriate limits. What is such a material substratum is open to discussion (see Romero 2017 for some possibilities discussed from a philosophical point of view).

4.8 Summary and Conclusions

Quantum mechanics is a remarkable theory. It is remarkable for its accomplishments and triumphs, and it is remarkable for its opacity of meaning and the distance from its insights to the dictates of common sense. The strangeness of the theory manifests mainly in the form of entanglement, wave-particle duality, and the lack of sharpness of some quantum properties. All these features can be accommodated within a realistic and objective interpretation of the theory. In such interpretation the referents of quantum mechanics are quantum systems and their environments. The states of these systems are represented by complex functions that belong to a functional space called Hilbert space. The specific properties of a particular system are given by self-adjoint operators that act upon the corresponding Hilbert space. The eigenvalues of the operators are identified with the values of the properties. Since the values are discrete, the system is said to be quantized. If two operators do not commute, the corresponding eigenvalues are not simultaneously sharp. Such indeterminacy of properties, called Heisenberg's inequalities or dispersion relations,

have nothing to do with observations. They just reflect the way of being of quantum objects.

The evolution of quantum systems obeys a linear equation. This equation can be formulated either for states or properties. The application of the Principle of Superposition to states leads naturally to entanglement. Once a system is prepared in a particular fashion, it evolves in such a way that its global properties are preserved. A result of this is the existence of non-local correlations among quantum states of the components of the system. This entanglement, very well verified from an experimental point of view, is no menace to the realist interpretation, conversely to what once Einstein thought. It only implies that quantum correlations in entangled systems are non-local.

The linearity of the dynamical equations of quantum mechanics also implies that the theory is fully deterministic. At each point of spacetime the state of a non-interacting quantum system is completely determined from the initial conditions. The theory is, nevertheless, probabilistic in the sense that from a given state just propensities can be evaluated for different possible outcomes. Such propensities are mathematically represented by probabilities that are determined from the rule given by Eq. (4.5). In the evolution of the propensities observers are not involved, but just interactions with the environment, that can be artificial, as in an experiment, or natural, as in most cases.

The so-called wave-particle duality actually does not exist. Quantum systems are neither waves nor particles. They can display under some conditions a behavior that might resemble that of a wave and under other circumstances that of a classical particle, but they are neither of them: they are *sui generis* entities. What kind of entities? In this chapter I have argued that quantum systems are fields extended over spacetime. What we call individual particles are just excitations of this field. The fact that they are actually properties of the field and not entities reveals itself when we realize that they are not relativistically invariant. Different vacuum states can be found for the same field. This results in particles being detected in one reference frame and not in another.

The property that characterizes ontological existence is energy: the capability of changing and producing changes. The energy density of the field is always well-defined in all reference frames and cannot be leveled by a change of frame. This shows that the underlying entities in the theory are the quantum fields. Since these fields interact among them, we say that they are material.

Finally, the spacetime over which these fields exist is material as well because it also has energy, albeit with non-local distribution.

So far, we can say that according to our current views of the physical world whatever exists is material. There seems to be two kinds of matter: fields and spacetime. Whether these two kinds of matter can be reduced one into the other, is something to be found.

Acknowledgements I am grateful to an anonymous reviewer for useful remarks. This work was supported by the Argentine agencies CONICET (PIP 2014-00338) and ANPCyT (PICT-2017-2865), as well as by the Spanish Ministerio de Economía y Competitividad (MINECO/FEDER, UE) under grant AYA2016-76012-C3-1-P and PID2019-105510GB-C31.

References

- Acuña, P. 2019. Charting the landscape of interpretation, theory rivalry, and underdetermination in quantum mechanics. *Synthese*. <https://doi.org/10.1007/s11229-019-02159-z>
- Aspect, A., Grangier, P., and G. Roger. 1981. Experimental tests of realistic local theories via Bell's Theorem. *Physical Review Letters* 47: 460–463.
- Aspect, A., Dalibard, J., and G. Roger 1982. Experimental test of Bell's Inequalities using timevarying analyzers. *Physical Review Letters* 49: 1804–1807.
- Bell, J.S. 1964. On the Einstein Podolsky Rosen paradox. *Physics* 1(3): 195–200.
- Bell, J.S. 1966. On the problem of hidden variables in quantum mechanics. *Reviews of Modern Physics* 38: 447–452.
- Bell, J.S. 2004. *Speakable and Unsayable in Quantum Mechanics*, 2nd ed. Cambridge: Cambridge University Press.
- Birrell N.D., and P.C.W. Davies. 1982. *Quantum Fields in Curved Space*. Cambridge: Cambridge University Press.
- Bohr, N. 1987. *The Philosophical Writings of Niels Bohr*, Vol. I. Woodbridge, Connecticut: Ox Bow.
- Bunge, M. 1956. A survey of the interpretations of quantum mechanics. *American Journal of Physics* 24: 272–286.
- Bunge, M. 1967. *Foundations of Physics*. New York: Springer-Verlag.
- Bunge, M. 1973. *Philosophy of Physics*. Dordrecht: Reidel.
- Bunge, M. 1974. *Treatise on Basic Philosophy, Vol.1: Sense and Reference*. Dordrecht: Kluwer.
- Bunge, M. 1977. Interpretation of Heisenberg's Inequalities. In *Denken und Umdenken*, ed. H. Pfeiffer. Munchen: R. Piper & Co., Verlag, pp. 146–156.
- Davies, P.C.W. 1975. Scalar particle production in Schwarzschild and Rindler metrics. *Journal of Physics A* 8: 609–616.
- Davies, P.C.W. 1984. Particles do not exist, in: *Quantum Theory of Gravity*, ed. S.M. Christensen. Bristol: Adam Hilger, Bristol, pp. 66–77.
- Dirac, P.A.W. 1930, *The Principles of Quantum Mechanics*. Oxford: Oxford University Press.
- Earman, J. 1986. *A Primer on Determinism*. Dordrecht, Holland: D. Reidel.
- Eckart, C. (1926). Operator calculus and the solution of the equation of quantum dynamics. *Physics Reviews* 28: 711–726.
- Einstein, A., B. Podolsky, and N. Rosen. 1935. Can quantum-mechanical description of physical reality be considered complete? *Physical Review* 47(10): 777–780.
- Feynman, R. 1965. *The Character of Physical Law*. New York: Modern Library.
- Freedman, S.J., and J.F. Clauser. 1972. Experimental test of local hidden-variable theories. *Physical Review Letters* 28(938): 938–941.
- Heisenberg, W. 1958. *Physics and Philosophy: The Revolution in Modern Science*. London: George Allen & Unwin.
- Heisenberg, W. 1962. *Physics and Philosophy*. New York: Harper and Row.
- Hobson, A. 2013. There are no particles, there are only fields. *American Journal of Physics* 81: 211–223.
- Jammer, M. 1974. *The Philosophy of Quantum Mechanics: the Interpretations of Quantum Mechanics in Historical Perspective*. New York: Wiley.
- Lewis, P.J. 2016. *Quantum Ontology: A Guide to the Metaphysics of Quantum Mechanics*. Oxford: Oxford University Press.
- London, F., and E. Bauer. 1939, *La théorie de l'observation en mécanique quantique*. Paris: Hermann, 1939. Translated in: J.A. Wheeler and W.H. Zurek. 1984. *Quantum theory and measurement*. Princeton: Princeton University Press.
- López Armengol, F., and G.E. Romero. 2017. Interpretation misunderstandings about elementary quantum mechanics. *Metatheoria* 7(2): 55–60.
- Margenau, H. 1954. Advantages and disadvantages of various interpretations of the quantum theory. *Physics Today* 7: 6–13.

- Messiah, A. 2014. *Quantum Mechanics*. Mineola: Dover.
- Norsen, T. 2017. *Foundations of Quantum Mechanics*. Cham: Springer.
- Oriti, D. (ed.) 2009. *Approaches to Quantum Gravity. Toward a New Understanding of Space, Time and Matter*. Cambridge: Cambridge University Press.
- Perez Bergliaffa, S.E., G.E. Romero, and H. Vucetich. 1993. Axiomatic foundations of non-relativistic quantum mechanics: A realistic approach, *International Journal of Theoretical Physics* 32: 1507–1522.
- Perez Bergliaffa, S.E., G.E. Romero, H. Vucetich. 1996. Axiomatic foundations of quantum mechanics revisited: The case for systems. *International Journal of Theoretical Physics* 35: 1805–1819.
- Ruetche, L. 2011. *Interpreting Quantum Theories*. Oxford: Oxford University Press.
- Romero, G.E. 2013. Adversus singularitates: The ontology of space-time singularities. *Foundations of Science* 18: 297–306.
- Romero, G.E. 2017. On the ontology of spacetime: Substantivalism, relationism, eternalism, and emergence. *Foundations of Science* 22: 141–159.
- Romero, G.E. 2018. *Scientific Philosophy*. Cham: Springer.
- Schlosshauer, M. 2007. *Decoherence and the Quantum-to-Classical Transition*. Berlin, Heidelberg, New York: Springer.
- Schrödinger, E. 1926. Über das Verhältnis der Heisenberg-Born-Jordanschen Quantenmechanik zu der meinen. *Annals of Physics* 79: 734–756.
- Unruh, W.H. 1976. Notes on black hole evaporation. *Physical Review D* 14: 870–892.
- von Neumann, J. 1955 (original 1932). *Mathematical Foundations of Quantum Mechanics*. Princeton: Princeton University Press.
- Wigner, E.P. 1995. *Philosophical Reflections and Syntheses*. Berlin and Heidelberg: Springer

Chapter 5

Spacetime Is Material



Luciano Combi

Abstract Space and time are central concepts for understanding our World. They are important ingredients at the core of every scientific theory and subject of intense debate in philosophy. Albert Einstein's Special and General theories of Relativity showed that space and time blend in a single entity called spacetime. Even after a century of its conception, many questions about the nature of spacetime remain controversial. In this chapter, we analyze the ontological status of spacetime from a realistic and materialistic point of view. We start by outlining the well-known controversy between substantivalism and relationalism and the evolution of the debate with the appearance of General Relativity. We analyze how to interpret spacetime as a physical system and how to model its properties in a background-free theory where spacetime itself is dynamical. We discuss the concept of change, energy, and the ontology of spacetime events. In the last section, we review the mereology of spacetime and its relevance in cosmology.

5.1 Introduction

Let us assume that the world is made of *things*. Now, assume these things *interact* with each other. From these interactions, some features of these things would *change*. This apparently trivial ontological picture contains three fundamental concepts that have been under dispute since pre-Socratic times: matter, space, and time.

The quest for understanding the nature of space and time has a rich history, both in physics and philosophy. Breakthroughs in science have often shaped and changed the philosophical landscape on this topic, and vice-versa. The standards of the debate were settled in the XVIII century, after the birth of modern theoretical physics by Galileo and Newton. In a famous epistolar debate, Leibniz and Clarke

L. Combi (✉)

Instituto Argentino de Radioastronomía (CONICET; CICPBA), Villa Elisa, Argentina

(on behalf of Newton) (Leibniz et al. 2000) discussed the ontological status of space: is space an absolute container where matter exists, or is it a concept that arises from the relations among things? (Jammer 2013). These two opposite views can be broadly classified as **substantivalism** and **relationism**. The exact meaning of these two currents of thought and the complexity of the debate have evolved through history, and so precise definitions are strongly context-dependent (see Huggett and Hofer 2018 and Romero 2017).

At the beginning of the XX century, Albert Einstein's formulation of Special and General Relativity (GR) produced a profound change in the discussion about space and time. In the words of Weyl:

And now, in our time, there has been unloosed a cataclysm which has swept away space, time and matter hitherto regarded as the firmest pillars of natural science, but only to make place for a view of things of wider scope, and entailing a deeper vision. This revolution was prompted essentially by the thoughts of one man, Albert Einstein. (Weyl 1922)

General Relativity is a non-linear theory about spacetime and matter.¹ The equations of motion of the theory determine the spacetime metric, which, in turn, represents the notion of distance and inertia for all physical objects. Different from any other previous theory, physical models do not occur in a fixed scenario; GR incorporates the background itself as a dynamical object. Thus, GR shows our three initial concepts harmoniously entangled: space and time constitute a sole entity that interacts with other entities. Famously put by Wheeler:

Spacetime tells matter how to move, matter tells spacetime how to curve (Misner et al. 1973).

Einstein's theory motivated many discussions on the foundations of physics and philosophy in general (Howard 2014). The radical novelties introduced by GR, and their complexity, pose numerous interpretation problems about its referents. In this work, we will focus on the materialistic aspects of spacetime and relativistic fields. This includes questions such as: is spacetime just another kind of matter field? What is the energy of spacetime? Does spacetime have parts? Does spacetime have entropy? What is a spacetime point? and other topics.

First, we offer a sketch of a basic ontological theory that we use throughout the chapter to maintain clarity, and we introduce the main features of relativity in this context. On this basis, we start discussing the substantivalist and relationist positions and their modern formulation. We discuss the nature of events and spacetime properties, emphasizing the background-independent character of the theory. On this basis, we explore different aspects of spacetime as a material being, e.g. spacetime interaction with other systems, evolution, and parts of spacetime. We present the notion of spacetime energy and radiation, and we address its difficulties. Finally, we analyze the main materialistic issues in cosmology.

¹ This implies among other things that spacetime is self-interacting.

5.2 Matter in Classical Relativity

5.2.1 Basic Concepts

An ontological theory describes the most general features of things. A scientific ontology is an ontology that is systematic, exact, and compatible with updated science (Bunge 1973). A coherent formulation of such a theory can be used as a guide to clarify the most basic concepts with which we deal in our physical theories. A relativistic ontology must encompass in a unified way the description of fields, particles, and spacetime. General Relativity offers a beautiful geometrical formalism for modeling these physical systems. Our job will be to disentangle and understand the basic features of this *relativistic matter* that arise from the theory. On the other hand, making our ontology explicit would help us face fundamental issues about the description of spacetime. We will follow a realistic ontology of things and properties.

Let us start by stating very basic ontological postulates:

- *Things*: A thing is represented as an individual with properties, $X := \langle x, P(x) \rangle$. Individuals can associate to form new individuals. Properties can be intrinsic (modeled as unary predicates) or relational (n-ary predicates on individuals).
- *Universe*: The Universe is made of all real things X . The Universe itself is a thing.
- *States*: A thing can be modeled as a finite sequence of mathematical functions $\{F_i\}$ over a mathematical space M , where the functions F_i represents a set of properties. A state of a thing is represented as a value of $\mathcal{F}(m)$ for some $m \in M$.

We will use these postulates only as a way to drive our discussion. For a more extended development and analysis of this ontological theory see Bunge (1977), Bergliaffa et al. (1993), and Romero (2018). Note that this ontology prioritizes things (primitive stuff) over structure, in contrast with the structural realism of Ladyman (2016), i.e. the idea that no objects are mediating the relations. As we will see in the sections below, GR is suitable to contrast and debate between these two positions (see also Esfeld and Lam 2008).

5.2.2 General Invariance and General Relativity

A physical theory T , for a thing σ of a certain kind Σ , has a set of laws that constrains its physical state space (Bunge 1967). Usually, this is done with a set of differential equations that specify relations between the system and other systems, or with itself. A convenient way to represent the properties, and state-space, of a theory, is using a geometrical language (Thorne and Blandford 2017). In a geometrical set-up, to formulate physical laws we ought to have a notion of *change* and a notion of *distance* between the geometric objects we define. This structure is called the **kinematical** framework of the theory (see the superb discussion by Stachel in Ashtekar 2005)

The proper geometric construct to represent this is a metric-affine manifold $(\mathcal{M}, \nabla, \mathbf{g})$: the *metric* defines distances and the *affine connection* a covariant derivative, i.e. a way to evaluate changes.² This formal affine structure characterizes the **inertial** behavior of objects in the theory, i.e. the physical state-space of a free system that is not interacting with other systems. A given kinematical framework defines space and time within a given theory (Rovelli 2018). In Newton's theory, physical distances between objects are Euclidean, sharing a common global time. In Special Relativity, on the contrary, distances are pseudo-Euclidean, meaning that (a) there is no unique global time and (b) there is a causal structure that distinguishes light and massive particles. Both theories share an important feature: the kinematical structure is fixed (Rovelli 2004). The dynamic of the theory, i.e. the set of equations, occurs on top of this structure.

Einstein's principle of equivalence (his "happiest thought") establishes that inertia and gravitation are of the same "essence". This statement was indeed the realization that the gravitational interaction changes the kinematical framework of physical theories and is not an additional force.³ In GR, Einstein promotes the entire kinematical structure of Special Relativity to a dynamical structure. This implies a profound *ontological shift* since the kinematical structure, the underlying way to describe the physical laws is now a representation of a dynamic physical system: spacetime. In short, there are no more fixed structures in the theory, relativity becomes general.

In GR, there is no preferred set of physical (inertial) systems that establishes a preferred reference frame, i.e., there are no privileged inertial coordinates (Rovelli 2004). The inertial and metric structure is set once we solve the dynamics of spacetime.⁴ The dynamic of GR is given by Einstein's field equations:

$$\mathbf{G}(\mathbf{g}, \nabla \mathbf{g}, \nabla^2 \mathbf{g}) = \frac{8\pi G}{c^4} \mathbf{T}(\mathbf{g}, \{\phi\}), \quad (5.1)$$

a set of ten second-order non-linear differential equations for the metric \mathbf{g} given a model for the energy-momentum tensor \mathbf{T} of ordinary matter such as fields or particles represented by a set of tensor fields ϕ . The absence of a fixed kinematical structure implies that the equations are invariant under active diffeomorphism, the most general invertible transformations of a manifold with itself. A model of the theory M is then an equivalence class of these transformations $M = \overline{(\mathcal{M}, \mathbf{g}, \{\phi\})}$, where \mathcal{M} is the manifold. Diffeomorphism transformations move points in the manifold into other points. If the theory is invariant under $\text{Diff}(\mathcal{M})$, we can define

² Other geometrical structures are possible for formulating physical theories, e.g. symplectic manifolds for phase space formulation.

³ This is true even in Newtonian physics. In its geometrical formulation, the affine connection is modified in the presence of gravity with a dynamic Cartan connection (Malament, 2006) while maintaining the Euclidean metric structure.

⁴ Note that these two structures are set by the dynamics of spacetime because the affine connection used is the Levi-Civita connection that is determined by the metric.

the notion of localization only with respect to other physical systems, i.e. properties are always relative to the properties of other systems. This is the core issue of Einstein’s Hole Argument that has been well-discussed in the literature over the years (Stachel 2014). On the other hand, in the classical vacuum case where we have only one entity, spacetime, it can be shown that we still have a consistent and non-trivial theory (see below).

5.3 Spacetime Ontology

5.3.1 *Substantivalism and Relationism: The Many Layers of the Debate*

Ontological positions about the character of motion, space, and time have been often classified as either *substantivalist* or *relationist*, a distinction most relevant in the physics of the XVIII century that has also been a point of controversy after Einstein presented his General Theory. To make sense of the debate nowadays, one has to be careful with the semantic content of the terminology employed; in Rynasiewicz’s words:

Present-day physicists do not employ a language that conforms with the original contrast, and the current controversy is fueled by so much squabbling over how to appropriate modern terminology to one’s own doctrinaire advantage (Rynasiewicz 1996).

Instead of analyzing what category is more appropriate, let us start from some formal grounds. A precise way to analyze a given theory \mathcal{T} is to take its axiomatic basis \mathcal{A} , from where all the consequences (statements) of the theory are derived

$$\mathcal{T} = \{s : \mathcal{A} \rightarrow s\}, \quad (5.2)$$

and specify at this foundational level what we mean by each referential (physical axiom) component (Bunge 1971). In this way, we characterize what elements are substantial, i.e., *things* in our ontology, or relational, i.e., emergent structures or properties of a collection of things. The concept of spacetime in physics is strongly theory-dependent. Indeed, many discussions have arisen by trying to adapt a given position, e.g., from Newtonian physics, to a more general theory⁵ such as General Relativity (see for instance the dynamical approach by Brown 2005). A better methodology is to start from the general theory and interpret the restricted theory based on the general ontology, e.g., from GR to flat spacetime (this is, in fact, non-trivial). In the following, we offer a brief outline of predominant relational and substantial arguments and interpretations in General Relativity.

⁵ By a “general thing”, we mean a theory T_1 whose range of applicability is longer than a theory T_2 from where $T_2 \subset T_1$. This implies that the ontology of T_1 is more akin to reality.

One of the most strict forms of relationism about spacetime is a heritage from Mach's ideas into GR. In this *Machian relationism*, matter systems generate the gravitational field that, in turn, determines the inertial properties of every system (see Huggett and Hoefer 2018). Spacetime then emerges as the system of all the relations between these bodies, i.e., an emergent property of \mathcal{U} , the system of all things, and not a thing itself (see Bergliaffa et al. 1998 for a modern exposition of this view). This early interpretation of GR changed after de Sitter presented his solution to Einstein's equation and the famous Einstein-de Sitter debate (Midwinter and Janssen 2011). This showed that the metric field is not entirely determined by the energy content of other matter, as Einstein expected, although it is constrained by it. It is widely accepted now that the metric represents a physical field, the gravitational field—or spacetime, which interacts with matter and has its dynamics.

The next question we might pose in the debate is whether spacetime and the gravitational field refer to different things. As we saw in the previous section, there is no independent concept of space and time without the metric. This was noted by Einstein himself and made him change his first Machian ideas:

On the basis of the general theory of relativity space as opposed to “what fills space” has no separate existence. If we imagine the gravitational field, i.e., the functions $g_{\mu\nu}$ to be removed, there does not remain a space of the type (1) (Minkowski spacetime), but absolutely nothing, and also no “topological space”. There is no such thing as an empty space, i.e., a space without a field. (Einstein 1956)

The debate at this point narrows. Note first the substantial and relational character of this interpretation: we have seen that the metric field represents a dynamic entity called spacetime (substantial), while the absence of prior background, highlighted by the Hole Argument, renders the theory relational. In the next section, we analyze another important aspect of the debate regarding the substantial character of events.

5.3.2 *Spacetime Events*

Following our sketched ontology, things are represented by elements of a set and properties as functions over these elements. In GR, we can think that each matter field, including spacetime, is an ontological entity. These material systems are represented in the theory by an equivalence class of manifold plus tensor fields. On the other hand, the manifold is itself a set of infinite elements with a topological and differential structure. It is then natural to ask whether manifold points represent some kind of entity with properties (this is what sometimes is called manifold substantialism, see Hoefer 1996). Given the background independence of GR, the concept of localization, or spacetime point, is only meaningful after solving the field dynamics. Different from Special Relativity, or Newtonian physics, this implies that matter does not evolve “on top of anything” and the theory is purely relational between its entities, i.e., the fields. Once the properties of the interacting systems are given, we can distinguish *events*. The ontological status

of events is still under discussion, and it has been the main target of the modern substantialism/relationalism debate (Romero 2017). An event e is represented as a set of relational statements of point-coincidence properties, e.g.,

$e =$ “spacetime has a Ricci scalar curvature of value R_0 when a particle σ has a position X and its proper time is τ_0 , i.e., $R(X(\tau_0)) \equiv R_0$.”

Again, these events are represented by points in an equivalence class of manifolds, once the field dynamic is solved. Each event is associated with a proper *spacetime point*. The question remains of whether we can consistently interpret these spacetime points as things with properties. Suppose that they are, in fact, some kind of factual entity. First, we cannot apply our ontological scheme of Sect. 5.1. The main reason is that these spacetime points are not individualized within the theory. We cannot take an event e , and formulate the equations of motions for that event because individuation is only inherited from the physical fields: we take the physical fields, we solve the dynamics, and only then it makes sense to talk about the properties, or existence of a particular event.⁶

Stachel has shown that the picture where the elements of the ontology are the fields is better described in the fiber bundle formalism of GR (Stachel and Iftime 2005), where we do not need an underlying manifold to formulate the theory. In this approach, he also describes events as having a common nature (what he calls *quiddity*) but lacking individuality (what he calls *haecceity*). In this sense, events seem to have some kind of ontological vagueness that reminds us of similar issues for identical particle states in quantum physics (Stachel et al. 2006).

If events can be ultimately described as things or not will depend on whether a consistent ontological theory of events compatible with GR can be formulated. A clear ontological picture here will lead the way to a theory of quantum gravity (see Romero 2013, 2016) for further discussions about the equivalence of these two pictures). With these clarifications, we now turn to the problem of change and properties in the context of relativity.

5.3.3 *Change and Properties within Spacetime*

A meaningful proposition about the properties of a system in a background independent theory such as GR must be formulated in a gauge-invariant form, i.e. it must be a relational statement. For instance, for a field Φ with a fundamental scalar property represented by the mathematical field $\phi(x^0, x^1, x^2, x^3)$, we need at least four numbers, or coordinates, to find a complete representation of the property. This complete representation can be built associating these coordinates to the properties of another system that we call reference frame (Rovelli 2002). We can, in principle, use spacetime itself as a reference frame. If spacetime is non-symmetric, we can

⁶ In this sense, there is a holistic flavor to General Relativity.

establish a set of four unique coordinates $\mathbf{C} = \{C^0, C^1, C^2, C^3\}$, using spacetime properties such as Weyl scalar invariants, which encode the degrees of freedom of the gravitational system. These are known as intrinsic Bergmann-Komar coordinates (Bergmann and Komar 1960). A property \mathcal{P} of a given material system can be then represented in general as $P(\mathbf{C})$, where P is a mathematical scalar. This means that *the value of the property \mathcal{P} with respect to \mathbf{C} , where spacetime has a unique set of properties, is $P(\mathbf{C})$* . Every local property can be understood to be relational with respect to spacetime: in a well-defined sense, we could say that matter lives on spacetime. In the construction of physical models, however, the use of Bergmann-Komar coordinates is very far from being a practical choice. Instead, we usually set a coordinate system that has some useful mathematical advantage or external physical interpretation and solve the equations of motion in that gauge. Once this is done, we can build gauge-invariant quantities and extract predictions from the theory. On the other hand, if spacetime has symmetries, then we need material systems acting as reference frames since we cannot distinguish certain states or parts from others using only spacetime properties (Smolin 2006).

Although spacetime is always interacting with other fields, spacetime can be dynamic even in the absence of other material entities, e.g. black holes can merge in a vacuum. This poses an obvious concern: how spacetime can be dynamic—changing in some sense—if there is no other thing to compare these changes with? One could be tempted to say that in a vacuum there are no dynamics (or that “time is frozen”), as is mentioned by some authors. But this would be against the usual practices of physics, and in fact, incorrect. The reason for this confusion is that there is no external time in GR, in contrast with Newtonian theories. Moreover, as we mentioned, other conceptual difficulties arise when we try to formulate well-behaved invariant quantities in a diffeomorphism invariant theory. In this section, we will focus on the philosophical part of the discussion, while the reader is invited to read Pons and Salisbury (2005) for the technical issues.

Spacetime properties are four-dimensional. We can fully characterize these properties, e.g. by putting them in terms of Bergmann-Komar coordinates. We can then separate or ‘slice’ these properties choosing an arbitrary foliation of space-like surfaces Σ , and a perpendicular time direction.⁷ In this 3 + 1 formulation, the evolution of spacetime can be described as the evolution of one ‘chunk’ with respect to an intrinsic time. If there is a global choice of time-variable t , we can parametrize each state as $\Sigma(t)$. This is the usual way to analyze and solve numerical models of high complexity in General Relativity (Baumgarte 2010). On the other hand, spacetime properties are partially ordered. i.e. there is an equivalence class of time-like curves connecting these properties. In the 3 + 1 picture, we are choosing a collection of spacetime properties ordered in some fashion. An asymmetric relation between these ordered properties shows that spacetime is non-trivial and dynamic.

⁷ This is possible assuming that the manifold is well behaved globally.

This asymmetry between the past and future is an invariant fact of spacetime, but the concrete description of the evolution depends on the frame we choose.⁸

It is important to note that spacetime is not the physical system of all the foliations $\{\Sigma(t)\}$. A physical system is the composition of two physical things, e.g., a hydrogen atom which is made of an electron and a proton. In this case, each foliation is a given state that we choose to describe the evolution of spacetime properties. Each of these foliations does not have an independent ontological status by itself. Although we can distinguish between different spacetime states, what is impossible to determine in the absence of other physical systems is an intrinsic length scale between these two events, i.e., it is not possible to measure a rate of change. Moreover, to establish an actual scale on spacetime, a concrete parametrized time-like curve is needed. This implies that a scale (e.g., clocks and rods) can only be established by massive systems, i.e., a system with non-zero energy in its fundamental state.

If an entity is interacting with spacetime, we can represent changes with respect to a reference frame attached to this thing (see Khavkine 2015 for self-consistent toy models that achieve this). Nevertheless, a formulation of change within spacetime is important to the extent that spacetime is the sole entity that can have non-trivial properties, at least classically, in the absence of other material systems. Any other system is subject to interaction with spacetime. This is implicitly stated in the formulation of physical theories. Summing up, we can state that spacetime is a changing entity but not with respect to an external time, as in a Newtonian ontology. Its change is always measured against other material systems or, in a weaker sense, we can define change noticing that the properties of spacetime are ordered.

Finally, it is useful to distinguish two important notions that are often seen as complementary: *existence* and *becoming*. Existence is a concept that cannot depend on conventions. If something exists, we must describe it as an invariant object of the theory. In General Relativity, this is best seen through a global conception of existence: a material system exists as a 4-dimensional “worm” *occupying* a hypersurface \mathcal{D} (Heller 1990), i.e., the spacetime region where the system interacts. In other words, the existence of a system σ is associated with its entire state-space, which defines a spacetime domain \mathcal{D} inheriting, from spacetime, a casual structure on it (Malament 2006). Usually, when we ask what *is* an object, we refer to this structure. In a Parmenidean sense, since this state cannot change, relativity commits to Eternalism (Romero 2013).

Our ontology postulates agree with this view since a concrete thing is defined as an individual with the entire state space of its properties. Although the existence of matter is unchangeable as a 4D object, this does not mean that time or change is altogether an illusion for entities. The important point is that General Relativity describes changes between systems as an objective fact of nature, but there is no preferred time variable to describe these changes. Contrary to a Newtonian ontology, what *exist* is not attached to a particular moment. On the other hand, note that

⁸ Paraphrasing Pierre Curie, *l'asymétrie crée le phénomène*.

physical laws are concerned with local change. The language of events or becoming seems more natural for doing physics; to test our theories, we look for processes and events. But events mark the interaction between two things. As we said, a pure ontology of events would have to look essentially different from our thing-based ontology.

5.3.4 Matter on Spacetime

In this section, we take a closer look into fields and particles, and their relation to spacetime (see also chapter by Romero in this volume). A field Φ is an entity with a fundamental relational property (or several of them) that we call intensity, represented as a tensor field $\phi(\mathbf{X})$, where \mathbf{X} are four-dimensional coordinates. On the other hand, a particle γ is an entity with a fundamental relational property called momentum, represented as a one-dimensional vector field $\mathbf{p}(\mathbf{X})$. Field and particles can also have intrinsic properties such as mass and charge that are imprinted in the equations of motion. Both fields and particles have an important property called energy-momentum. Energy, as an ontological property, represents the changeability of a thing (Bunge 2010). Every physical theory has a representation of energy for its physical objects. Noether's theorem beautifully connects the energy of a system with the properties of spacetime. Given a time symmetry in spacetime, represented by a Killing vector \mathbf{t} , if the state of a system is invariant with respect to \mathbf{t} , then the energy of the system is conserved. In general, we do not have a preferred notion of time in spacetime, so conserved quantities only arise in very special cases.

Energy-momentum is the relativistic extension of the concept of energy. In GR, this is represented as a symmetric tensor $T_{\mu\nu}$ which is defined as the functional derivative of the Lagrangian \mathcal{L} with respect to the metric:

$$T_{\mu\nu} := -2 \frac{\partial \mathcal{L}}{\partial g^{\mu\nu}} + \mathcal{L} g_{\mu\nu}. \quad (5.3)$$

From this definition, we observe that the concept of energy-momentum is linked intrinsically to spacetime since the energy-momentum tensor depends explicitly on the metric \mathbf{g} . As stated by Lehmkuhl (2011), the concept of energy cannot be conceived without an underlying spacetime. On the other hand, the dynamics of spacetime given by Einstein's equations are only affected by matter through its energy-momentum. This can be understood as a consequence of the strong equivalence principle (De Felice and Clarke 1992): no matter the intrinsic nature of matter, spacetime is only concerned with its energy-momentum.

Particles are part of most classical ontologies both in Newtonian and Relativistic physics. Their interaction with spacetime is through the inertial structure, determined in GR by the metric. The dynamic of a particle is given by the force equation:

$$\mathbf{p} \cdot \nabla \mathbf{p} = \mathbf{F}, \quad (5.4)$$

where the covariant derivative ∇ is determined by the affine connection and \mathbf{F} is the force, denoting the interaction with other entities. Contrary to a field, a particle cannot interact with itself and its energy-momentum encodes a complete representation of its properties.⁹ This is why the state of the particle is completely determined by the conservation of the energy momentum. In the absence of forces, a particle only interacts with spacetime. If we consider the back-reaction of the particle onto spacetime in this idealized model, we get an ill-defined metric that far from the particle position, looks like the Schwarzschild metric of mass m (Katanaev 2013). Physically, however, we know that any sufficiently dense distribution of mass would lead, in the end, to a black hole, and so this model is only valid at certain scales. Indeed, there are several reasons to think that particles are not fundamental in the ontology of the World. In the quantum regime, particles are frame-dependent excitations of some underlying field. In the classical regime, we can also think of particles as the geometrical optic limit of some field, where the wave behavior of the latter is washed out at some limit (Misner et al. 1973). The intrinsic properties of the field would determine the initial inertia state of the particle; if the field is massive, then the particle moves in a time-like curve, while a massless field follows null curves.

If we consider an average description of a collection of non-interacting particles we can formulate the simplest field theory: a dust fluid. This field is characterized by a rest-mass density field $\rho(\mathbf{X})$ and a velocity field. Similar to a single particle, the dynamic of a dust field is given by the conservation of the energy-momentum alone. If we include interactions into the field model, we need to add other fundamental quantities such as pressure and viscosity (Thorne and Blandford, 2018). Contrary to a fluid, which is a statistical description of more fundamental entities, there are fields in nature that are fundamental. In the classic regime, the most relevant example is the electromagnetic field, with a fundamental property represented by the Faraday tensor $F^{\mu\nu}$. Since the electromagnetic field is an unobservable entity, there have been debates about its physical reality (Bunge 1967) and attempts to formulate theories without them. It is now widely accepted that fields are real referents of our physical theories for various reasons, including most notably their successful description of physical reality in the quantum realm.

5.3.5 *Gravitational Energy, Radiation, and Thermodynamics*

As we discussed above, the energy of matter is closely related to the notion of change in spacetime. The absence of an external (or preferred) time variable in spacetime makes the problem of assigning energy to gravity non-trivial. By the equivalence principle, the local properties of a free system that moves in curved

⁹ The energy-momentum of a particle is not well-defined, but we can build a tensor in the sense of distributions.

spacetime remain unchanged. In other words, locally, spacetime looks flat. This shows that a local notion of gravitational energy is elusive. Gravitational energy must be, at least, a quasi-local concept, a quantity that characterizes an extended region and not a local region. Besides, to build physically relevant energy associated with spacetime, we have to be careful and described it for a specific reference frame.

A natural choice is to separate two regions of spacetime, one that is highly dynamical, \mathcal{D} , and another far away, \mathcal{O} , where nothing happens. In this manner, we try to quantify the energy in \mathcal{D} with respect to \mathcal{O} . This is the basic idea of the ADM (Arnowits-Desser-Misner) mass, M , defined as the surface integral:

$$M = -\frac{1}{8\pi} \lim_{r \rightarrow \infty} \oint_S (k - k_0) dS, \quad (5.5)$$

where k is the extrinsic curvature of a surface S , k_0 is the extrinsic curvature of S embedded in flat spacetime, and dS is the surface element (Poisson 2004). This quantifies, from the superficial curvature, the energy contained in the inner region, as described by a faraway observer. When we speak about the mass of black holes, we are usually referring to this construct.

In a dynamic scenario like the inspiralling and merging of two black holes, part of the energy is radiated away from the dynamical region, and the rest remains in the remaining black hole. The final mass of the black hole cannot be calculated using the ADM construct, because the prescription to calculate the energy includes all the gravitational energy in the domain, the radiation, and the stationary mass. In this case, to calculate the remaining mass, we have to use a concept of energy that takes into account this radiation separately. The useful quantity here is the Bondi-Sachs mass, M_{BS} , which uses a null surface to measure the energy, meaning that any radiated energy remains in the past. The rate of change with respect to a locally flat time is given by:

$$\frac{dM_{BS}}{du} = - \oint_{\mathcal{I}^+} F dS, \quad (5.6)$$

where F is the gravitational flux (see Fig. 5.1 to compare both ADM and Bondi-Sachs constructs). Contrary to the ADM mass, this mass can be connected directly with observations at a gravitational wave detector by measuring the energy flux, and thus infer the final mass of the black hole.

The previous energy concepts we showed need a reference frame at infinity, assuming that very far from the source, spacetime is flat. This precise notion allows to properly characterize an *isolated system* in curved spacetime (Wald 1984). Instead, if a given system is embedded in an expanding Universe, these definitions need to be revised (see next section). The energy constructs that we described so far are global in character. In principle, we could apply the same concept in a *quasi-local* manner, that is, in a finite region around a certain point. For the quasi-local case, we do not have a preferred way to choose our reference frame so there are many quasi-local energy definitions. Two of the most mathematically well-defined

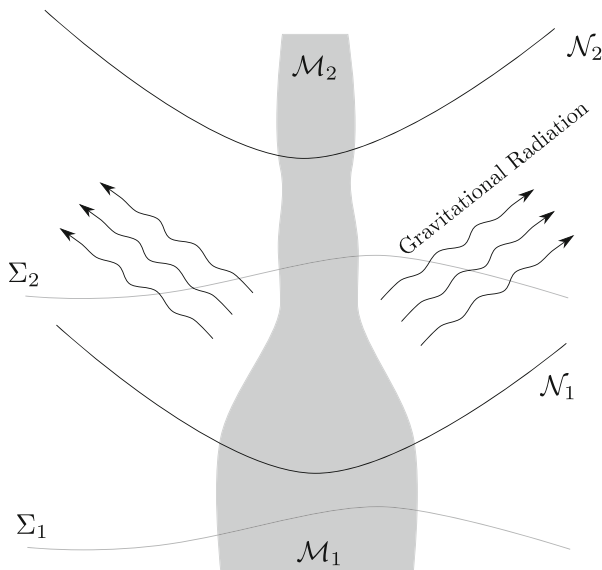

Fig. 5.1 In this figure we show a sketch of a gravitational source, for instance, a perturbed black hole, with mass \mathcal{M}_1 at an initial time as computed with both the ADM and Bondi-Sachs mass. After the perturbations are radiated away as gravitational waves, the rest mass of the black hole is \mathcal{M}_2 . The ADM mass contained in the spatial surface Σ_2 , however, gives us information about all the energy available in space-time so again it gives \mathcal{M}_1 . On the other hand, the Bondi-Sachs mass, computed with a null surface \mathcal{N}_2 leaves the radiated energy in the past, giving the proper mass of the black hole

and physically motivated concepts of energy are the Hawking and Brown-York energy formalisms. Another alternative is to try building an energy momentum for spacetime. These are usually pseudo-tensors (Landau 2013) and, again, are only physically meaningful when a proper reference frame or a set of physical coordinates is chosen.

The fundamental character of spacetime in defining the kinematical structure of matter has interesting consequences in thermodynamics for two reasons: the formulation of the first law and equilibrium in curved spacetime, and the role of spacetime in increasing the entropy of a system. For instance, it can be shown that the interaction of spacetime and matter in a thermal bath can create temperature gradients in equilibrium without violating the first law of thermodynamics, e.g. in presence of a black hole, we can have the Tolman temperature for a stationary fluid (see Santiago and Visser 2018 for a recent discussion on this topic).

The question of entropy and the second law is more subtle. If the second law of thermodynamics is globally valid, then there seems to be a contradiction on how the Universe evolved from a thermal equilibrium state that maximizes the entropy and the current state of the Universe that is colder and structured. A usual proposed solution to this problem is to assume that spacetime carries entropy itself and in the early Universe it was in a low entropy state. Then, via gravitational collapse,

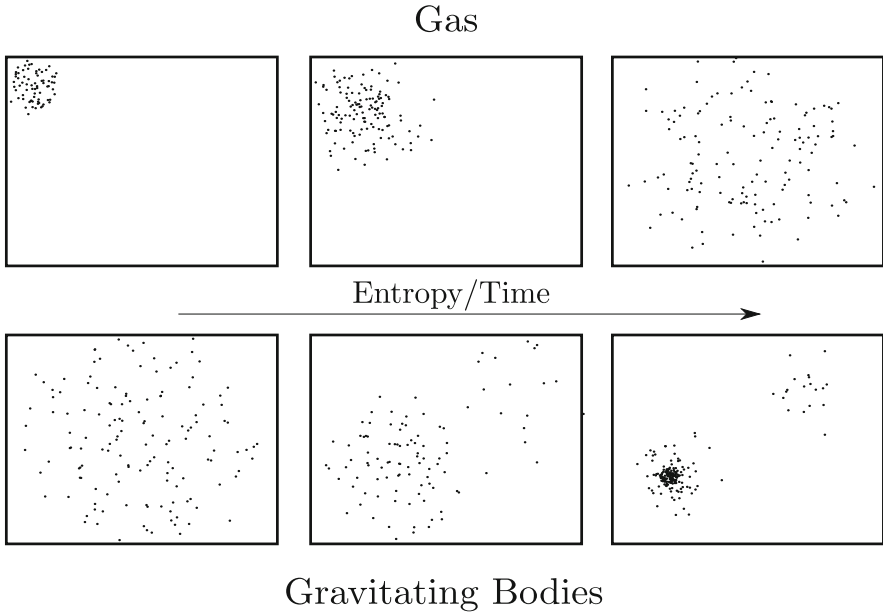

Fig. 5.2 Thermodynamic picture of a system without (up) and with (down) gravitational interaction taken into account

spacetime entropy grows with the formation of black holes as a limiting case (see Fig. 5.2). Although we do not have a microscopic theory of spacetime to obtain a self-consistent measure of entropy, there have been attempts to find prescriptions for a classical entropy. A promising proposal is due to Penrose, who proposed that the conformal invariant Weyl tensor, representing the degrees of freedom of spacetime, could be used to build a proper estimation of the entropy (see Clifton et al. 2013 for a concrete realization). This is also motivated by the second law analog of entropy found for black holes, where the entropy of a black hole is proportional to its area, which is always growing (Bekenstein 1973).

This simplified picture of the thermodynamics of baryonic matter and spacetime has some nuances (Wallace 2010). First, note that spacetime acts mainly as a catalyst for entropy increasing processes, clustering matter to allowing thermonuclear reactions in stars and other systems. The process of clustering in the presence of gravity indeed can be entropically favored since, although matter entropy decreases when a structure is formed, it emits highly entropic radiation. In most local scenarios, e.g. to develop life on earth, the gravitational entropy itself is not relevant to increase the local entropy; in the cosmological picture, however, black holes carry an enormous amount of entropy. In this context, it is argued by Wallace that the low entropy state of spacetime in the early Universe is not the only reason why the Universe is evolving to a more entropic state; in short: (a) when gravity is taken into account, non-uniformity increases entropy via thermal processes induced by gravity, and in

particular cases by black holes, and (b) the Universe was not in global equilibrium due to the rapidness of its expansion. Even though these remarks are important, it is clear that spacetime stores entropy and energy in a very different way than normal matter.

5.4 Cosmology and the Scales of Spacetime

Cosmology, the study of the Universe as a whole, started as a scientific discipline with Einstein's first model of a static Universe in 1917 and the discovery of the redshift-distance relation of Hubble, showing that the Universe is dynamic and expanding. Although cosmology has always been (and to some degree is) a concern for philosophers, nowadays, with large surveys and advanced telescopes, cosmology has become a precision science. The standard model of cosmology is the so-called Λ CDM model (Ellis et al. 2012), which most notably implies that (a) the Universe is homogenous and isotropic at large scales, (b) is currently expanding in an accelerated manner, (c) there was a Hot Big Bang in the past, and that (d) equations of GR must be supplemented by a linear term with a small constant Λ called the Cosmological Constant.

The philosophical issues around cosmology are vast and it could take an entire chapter (see the excellent discussion of Ellis in Butterfield and Earman 2006). But here we are concerned with the material aspects of the Universe. In particular, with the following three issues: is the Cosmological Constant a thing? what are the parts of an expanding Universe? how do these parts interact?

Let us begin by the nature of the Cosmological Constant. First introduced by Einstein, the cosmological constant is the simplest modification of Einstein's equations in the form:

$$\mathbf{G}(\mathbf{g}, \nabla\mathbf{g}, \nabla^2\mathbf{g}) + \Lambda\mathbf{g} = \frac{8\pi G}{c^4}\mathbf{T}(\mathbf{g}, \{\phi\}), \quad (5.7)$$

Often referred to as "dark energy", the Λ contribution plays a fundamental role in modern cosmology since it provides an explanation for the accelerated state of the Universe (Carroll 2001). Physicists often speak about a fundamental mystery surrounding this constant. Although this has motivated alternative explanations for Λ and new theories, the character of the problem is greatly exaggerated (see Bianchi and Rovelli 2010). There are two possible ways to interpret the constant, either (a) we reify it or (b) we accept that we must modify Einstein's equations. Its reification, promoting Lambda to a physical property of some entity, comes in two flavors. First, we could assume that Λ represents a property of spacetime itself, the vacuum energy. It is a well-known problem that the calculation of the vacuum energy performed in Quantum Field Theory gives a result of 55 orders of magnitude larger than the actual observed value. As it is explained in Bianchi and Rovelli (2010), it is a mistake to a priori identify this constant as the vacuum energy,

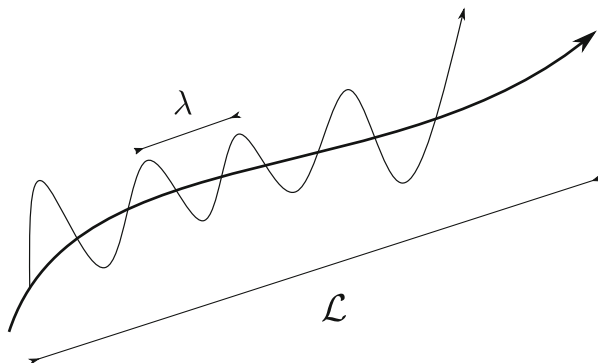

Fig. 5.3 In some cases, spacetime properties can be separated into a background, with some scale \mathcal{L} , plus perturbations, with a scale given by λ . These are also known as the low-frequency and high-frequency modes, respectively. This is a typical scenario for gravitational waves or cosmological perturbations. Because of non-linearities, the effects of the background to the propagations of the perturbations (top-down) and the contributions of the propagations to the background itself (bottom-up) are nontrivial problems

since the mechanism of quantum gravity is still unknown. Second, we could assume that Λ is a property of a quintessential substance that is dynamic, e.g. a scalar field. No compelling evidence has been found to prove this so far. Although there are interesting alternatives for the Cosmological Constant such as $f(R)$ theories, there are no convincing arguments about why Λ should not be just a fundamental constant of nature such as G and c that is included in the equations. The fuzz is indeed unjustified.

In any case, the presence of the Cosmological Constant changes the structure of spacetime itself. When spacetime does not possess asymptotic flatness, it is hard to extract information of isolated, e.g. energy measures and gravitational waves (Ashtekar et al. 2014). Asymptotic flatness endows spacetime with several desired properties that are not present when the cosmological constant is present.¹⁰

Because of the non-linear nature of spacetime, the interaction between small scales and large scales is non-trivial (see Fig. 5.3). There are indeed interesting **top-down** and **bottom-up** problems. Let us revise the bottom-up problem first. In the early universe, the matter was in a hot and dense plasma state. This plasma is very well-approximated *everywhere* by the energy-momentum tensor of a homogenous and isotropic perfect fluid. The solution to Einstein's equations for this case is the well-known FLRW metric. As the universe evolves and structure is formed, the matter is homogeneous only over big scales of hundreds of megaparsecs. To solve

¹⁰ In particular, when $\Lambda \neq 0$, the well-defined notion of a null boundary at null infinity is a spacelike surface, and thus there is no preferred way to calculate physical quantities. When spacetime is expanding all notions of infinity are origin-dependent; natural boundaries appear in spacetime known as horizons (Ashtekar and Krishnan 2004).

the dynamic of the whole universe we thus have to take averages on these scales and solve the averaged Einstein's equations. If the averaged matter is homogenous, do we recover the FLRW metric? It turns out that given the non-linearity of Einstein's equations, the averaged equations are different from the exact equations. This is the so-called backreaction problem: does the presence of inhomogeneities change the global solution?

An important debate among cosmologists has been going on over the past decade to address this problem. Green and Wald (2011) have argued that in a weak-perturbation scheme where the dynamics of the Universe is described a metric with the parts:

$$g_{\mu\nu} = g_{\mu\nu}(0) + \gamma_{\mu\nu}, \quad (5.8)$$

being $g(0)$ the homogenous Universe and γ representing the arguably small inhomogeneities, backreactions are very small and not relevant in observations. This is not an obvious conclusion since derivatives of the perturbations are not bound by how small the perturbations are. This is the important result demonstrated by Green and Wald (2011). A strong response to this work has been given by Buchert et al. (2015), where they discuss the limitation of the Green and Wald scheme (see also the response by Green and Wald 2015). In particular, they point out that the way they consider backreactions is not general. In the Green and Wald scheme, local deviations to the homogenous spacetime are small with respect to the whole global background. If instead, we consider small ripples that accumulate over the averaging at large scales, it is possible to build a global inhomogeneous model of the Universe (Korzyński 2015). Inhomogenous cosmologies are relevant because they could explain current observations of the accelerated Universe as an alternative to the standard model (Buchert et al. 2016).

On the other hand, the top-down problem is concerned with whether the global state of the Universe can have effects on local systems, changing their dynamics (Ellis 2002; Giulini 2014). As we have seen, the mere identification of a local gravitational system is problematic in an expanding Universe. Spacetime subsystems are well defined, in a four-dimensional sense, when we can distinguish, globally, two consistent sets of properties within it. This is the case of a black hole, defined as the non-causally connected part of the entire spacetime (impossibility of escaping to future null infinity). When spacetime is expanding, global notions are hard to establish, so we need quasi-local descriptions of a system (Ashtekar and Krishnan 2004). For instance, in an expanding universe, it is hard to find black hole solutions. Finally, in the Newtonian approximation, the expanding Universe implies a change in the local inertia of the system that accelerates or deaccelerates bodies (Carrera and Giulini 2010). Structures of parsec scale such as galaxy clusters might be affected by this effect and have an observable change in their size.

All this interconnectedness shows something fascinating: understanding our surroundings might give us information about the entire Universe, and the other way around. A typical issue of emergence arises at this point. If the Universe is unique, we cannot distinguish boundary conditions from physical laws locally (Ellis

2002). If the “global physical laws” are different, as the Universe is changing, we might observe changes in our “local physical laws”, for instance, by variations of the fundamental constants of nature.

5.5 Conclusions

Spacetime is material. In the sense that we discussed above, it can change and interact. But it is a different kind of matter. In this chapter, we discussed some of the issues regarding the materiality of classical spacetime. The radical novelty introduced with General Relativity, i.e. background independence, has profound consequences on the ontological status of what we understand as time, space, and matter. This makes the characterization of some of its material properties conceptually difficult to establish. Following a clear materialistic ontology, we discussed the philosophical issues of defining self-interaction, spacetime parts, spacetime energy, and the concept of scale within spacetime. An understanding of these issues is necessary to get a clear picture that can lead the way to a quantum theory of gravity if such a theory could be formulated.

Appendix: Dictionary of Technical Terms

In this section, we give some useful definitions regarding spacetime and spacetime symmetries to complement the article.

Spacetime model A spacetime model $M = (\mathcal{M}, \mathbf{g})$ is a real, four-dimensional connected C^∞ Hausdorff manifold with no boundaries, with a globally defined C^∞ -tensor field \mathbf{g} of type (0,2), non-degenerate, and Lorentzian (Wald 1984).

Affine connection A covariant derivative in the direction of a vector \mathbf{W} , $\nabla_{\mathbf{W}}$, is a derivative operator that transforms tensors into tensors. The operator is completely determined through its application to a basis of spacetime \mathbf{e}_a , in the direction of the same basis

$$\nabla_a \mathbf{e}_b = \omega_{ab}^c \mathbf{e}_c. \quad (5.9)$$

The quantity ω_{ab}^c is called the affine connection of ∇ .

Equation of motion Following Giulini (2007), we represent a general equation of motion (EOM) of a given physical theory by:

$$E[g, \gamma, \Phi; \Sigma] = 0, \quad (5.10)$$

where E is some differential operator, g designates the spacetime metric, γ designates a set of particle models, Φ designates a set of physical fields, and Σ designates some geometrical and non-dynamical structures that must be given. The latter is usually referred to as the *absolute structure* of the theory and can be referential or non-referential. There is no general consensus about a formal definition of the absolute structures of a given theory. The dynamical fields (g, γ, Φ) are unknown and meant to be solved, given Σ .

Covariance An EOM is **covariant** under the subgroup $G \subseteq \text{Diff}(M)$ iff for all $f \in G$:

$$E[g, \gamma, \Phi; \Sigma] = 0 \iff E[f \cdot g, f \cdot \gamma, f \cdot \Phi; f \cdot \Sigma] = 0. \quad (5.11)$$

Remark As stated by Giulini, covariance requires the equation to ‘live on the manifold’; in other words, to refer to well-defined geometrical objects with given transformation laws under $f \in G$. The equation remains valid after the action of $f \in G$, but it is different from the original, since the components of Σ are different.

Invariance An EOM is **invariant** under the subgroup $G \subseteq \text{Diff}(M)$ iff for all $f \in G$:

$$E[g, \gamma, \Phi; \Sigma] = 0 \iff E[f \cdot g, f \cdot \gamma, f \cdot \Phi; \Sigma] = 0. \quad (5.12)$$

Remark An invariant diffeomorphism $f \in G$ keeps the equation identical, since the components of Σ are unchanged. In this way, invariance is much more restrictive than covariance. The invariant group of a given equation is inherited by the invariance group of the absolute structures Σ . Since the transformed equation is identical to the original, from a solution of the dynamical fields we can obtain a whole set of solutions related by invariant diffeomorphisms.

General Covariance An EOM is **general covariant** if it is covariant under the group $G = \text{Diff}(M)$.

Remark The equations of any theory can be written, in principle, in a general covariant way (Rovelli 2004). This process is usually carried out to make the equations of a given theory compatible with GR, but this is not necessarily the case. In fact, a given covariant theory under a specific group of transformations can be made general covariant in many non-equivalent ways. The key assumption in GR ‘covariantization’ is that we assume the metric is the only external geometrical object, and thus, the connection, introduced to define a meaningful notion of change, is the Levi-Civita connections. Adding, for instance, additional tetrad fields or other geometrical objects to construct a more general connection would render a Lorentz covariant equation general covariant but with the wrong limit in GR. Finally, let us define

General Invariance An EOM is **general invariant** if it is invariant under the group $G = \text{Diff}(M)$.

Remark: This definition seems to imply that a theory with a general invariant EOM would be background independent. As we pointed out earlier, however, a precise definition of background independence is very subtle and is not equal to general invariance. We shall present the classical definition by Anderson (1967) that is not, however, free of problems (see also Friedman 1973):

Background Independence (Anderson) A theory is background independent if their dynamical EOM are free of absolute structures.

Remark From the previous definitions, it follows that the equations of motion of any background independent theory, written in a general covariant way, are general invariant as well. That is the case with GR. There are various constructs in GR, however, that can be considered absolute, e.g. dimensions and signature, volume elements, etc.

Acknowledgements I would like to dedicate this contribution to the memory of Mario Bunge. I'm grateful to G.E. Romero for his intellectual guidance, and to Federico Lopez Armengol for many discussions on the nature of spacetime. This work was partially funded by a CONICET fellowship.

References

- Anderson, J.L. 1967. *Principles of Relativity Physics*. New York: Academic Press.
- Ashtekar, A. 2005. *100 Years of Relativity: Space-Time Structure: Einstein and Beyond*. London: World Scientific.
- Ashtekar, A., and B. Krishnan. 2004. Isolated and dynamical horizons and their applications. *Living Reviews in Relativity* 7(1): 10.
- Ashtekar, A., B. Bonga, and A. Kesavan. 2014. Asymptotics with a positive cosmological constant: I. basic framework. *Classical and Quantum Gravity* 32(2): 025004.
- Baumgarte, T.W., and S.L. Shapiro. 2010. *Numerical Relativity: Solving Einstein's Equations on the Computer*. Cambridge: University Press.
- Bekenstein, J.D. 1973. Black holes and entropy. *Physical Review D* 7(8): 2333.
- Bergliaffa, S.P., H. Vucetich, and G.E. Romero. 1993. Axiomatic foundations of nonrelativistic quantum mechanics: A realistic approach. *International Journal of Theoretical Physics* 32(9): 1507–1522.
- Bergliaffa, S.P., G.E. Romero, and H. Vucetich. 1998. Toward an axiomatic pregeometry of space-time. *International Journal of Theoretical Physics* 37(8): 2281–2298.
- Bergmann, P.G., and A.B. Komar. 1960. Poisson brackets between locally defined observables in general relativity. *Physical Review Letters* 4(8): 432.
- Bianchi, E., and C. Rovelli. 2010. Why all these prejudices against a constant? *arXiv preprint arXiv:10023966*.
- Brown. 2005. *Physical Relativity: Space-Time Structure from a Dynamical Perspective*. Oxford: Oxford University Press.
- Buchert, T., M. Carfora, G.F. Ellis, E.W. Kolb, M.A. MacCallum, J.J. Ostrowski, S. Räsänen, B.F. Roukema, L. Andersson, A.A. Coley, et al. 2015. Is there proof that backreaction of inhomogeneities is irrelevant in cosmology? *Classical and Quantum Gravity* 32(21): 215021.
- Buchert, T., A.A. Coley, H. Kleinert, B.F. Roukema, and D.L. Wiltshire. 2016. Observational challenges for the standard FLRW model. *International Journal of Modern Physics D* 25(3): 1630007.
- Bunge, M. 1967. *Foundations of Physics*. Heidelberg: Springer.

- Bunge, M. 1971. *Treatise on Basic Philosophy: Semantics I: Sense and Reference*, vol. 1. Dordrecht: Kluwer.
- Bunge, M. 1973. Is scientific metaphysics possible? In *Method, Model and Matter*. Heidelberg: Springer, pp 145–159.
- Bunge, M. 1977. *Treatise on Basic Philosophy: Ontology I: the Furniture of the World*, vol. 3. Heidelberg: Springer.
- Bunge, M. 2010. *Matter and Mind: A Philosophical Inquiry*. Heidelberg: Springer.
- Butterfield, J., and J. Earman. 2006. *Philosophy of Physics*, vol. 2. Amsterdam: Elsevier.
- Carrera, M., and D. Giulini. 2010. Influence of global cosmological expansion on local dynamics and kinematics. *Reviews of Modern Physics* 82(1): 169.
- Carroll, S.M. 2001. The cosmological constant. *Living Reviews in Relativity* 4(1): 1.
- Clifton, T., G.F. Ellis, and R. Tavakol. 2013. A gravitational entropy proposal. *Classical and Quantum Gravity* 30(12): 125009
- De Felice, F., C.J.S. Clarke. 1992. *Relativity on Curved Manifolds*. Cambridge University Press.
- Einstein, A. 1956. *Relativity: The Special and the General Theory*. London: Crown Publishers.
- Ellis, G.F. 2002. Cosmology and local physics. *New Astronomy Reviews* 46(11): 645–657.
- Ellis, G.F. 2011. Inhomogeneity effects in cosmology. *Classical and Quantum Gravity* 28(16): 164001.
- Ellis, G.F., R. Maartens, and M.A. MacCallum. 2012. *Relativistic Cosmology*. Cambridge: Cambridge University Press.
- Esfeld, M., and V. Lam. 2008. Moderate structural realism about space-time. *Synthese* 160(1): 27–46.
- Friedman, M. 1973. *Foundations of Space-Time Theories: Relativistic Physics and Philosophy of Science*. Princeton: Princeton University Press.
- Giulini, D. 2007. Remarks on the notions of general covariance and background independence. In *Approaches to Fundamental Physics*. Heidelberg: Springer, pp 105–120.
- Giulini, D. 2014. Does cosmological expansion affect local physics? *Studies in History and Philosophy of Science Part B: Studies in History and Philosophy of Modern Physics* 46: 24–37
- Green, S.R., and R.M. Wald. 2011. New framework for analyzing the effects of small scale inhomogeneities in cosmology. *Physical Review D* 83(8): 084020.
- Green, S.R., and R.M. Wald. 2015. Comments on backreaction. *arXiv preprint arXiv:150606452*.
- Heller, M. 1990. *The Ontology of Physical Objects: Four-Dimensional Chunks of Matter*. Cambridge: Cambridge University Press.
- Hofer, C. 1996. The metaphysics of space-time substantialism. *The Journal of Philosophy* 93(1): 5–27
- Howard, D. 2014. Einstein and the development of twentieth-century philosophy of science. In *The Cambridge Companion to Einstein*. Cambridge: Cambridge University Press, pp. 354–376.
- Huggett, N., and C. Hofer. 2018. Absolute and relational theories of space and motion. In *The Stanford Encyclopedia of Philosophy* online, spring 2018 edition, Metaphysics Research Lab, Stanford University.
- Jammer, M. 2013. *Concepts of Space: The History of Theories of Space in Physics*. US: Dover.
- Katanaev, M.O. 2013. Point massive particle in General Relativity. *General Relativity and Gravitation* 45(10): 1861–1875.
- Khavkine, I. 2015. Local and gauge invariant observables in gravity. *Classical and Quantum Gravity* 32(18): 185019.
- Korzyński, M. 2015. Nonlinear effects of general relativity from multiscale structure. *Classical and Quantum Gravity* 32(21): 215013.
- Ladyman, J. 2016. Structural realism. In: *The Stanford Encyclopedia of Philosophy*, winter 2016 edn, Metaphysics Research Lab, Stanford University.
- Landau, L.D. 2013. *The Classical Theory of Fields*, vol. 2. Amsterdam: Elsevier.
- Lehmkuhl, D. 2011. Mass–energy–momentum: Only there because of spacetime? *The British Journal for the Philosophy of Science* 62(3): 453–488.
- Leibniz, G.W., S. Clarke, and R. Ariew. (2000) *Leibniz and Clarke: Correspondence*. US: Hackett Publishing Company.

- Malament, D.B. 2006. *Classical Relativity Theory. Handbook of the Philosophy of Science Philosophy of Physics Part A*. Amsterdam: Elsevier, pp 229–275.
- Midwinter, C., and M. Janssen. 2011. Castles in the air: The Einstein-De Sitter Debate, 1916–1918. In *APS Meeting Abstracts*. US: APS, pV24.001.
- Misner, C.W., K.S. Thorne, and J.A. Wheeler. 1973. *Gravitation*. Princeton: Princeton University Press.
- Poisson, E. 2004. *A Relativist's Toolkit: The Mathematics of Black-Hole Mechanics*. Cambridge: Cambridge University Press.
- Pons, J.M., Salisbury, D.C. 2005. Issue of time in generally covariant theories and the Komar-Bergmann approach to observables in general relativity. *Physical Review D* 71(12): 124012
- Rynasiewicz, R. 1996. Absolute versus relational space-time: An outmoded debate? *The Journal of Philosophy* 93(6): 279–306.
- Romero, G.E. 2013. From change to spacetime: An eleatic journey. *Foundations of Science* 18(1): 139–148.
- Romero, G.E. 2016. A formal ontological theory based on timeless events. *Philosophia* 44(2): 607–622.
- Romero, G.E. 2017. On the ontology of spacetime: Substantivalism, relationism, eternalism, and emergence. *Foundations of Science* 22(1): 141–159.
- Romero, G.E. 2018. *Scientific Philosophy*. Heidelberg: Springer.
- Rovelli, C. 2002. Partial observables. *Physical Review D* 65(12): 124013.
- Rovelli, C. 2004 *Quantum Gravity*. Cambridge: Cambridge University Press.
- Rovelli, C. 2018. Space and time in loop quantum gravity. *arXiv preprint* arXiv:180202382.
- Santiago, J., and M. Visser. 2018. Gravity's universality: The physics underlying Tolman temperature gradients. *International Journal of Modern Physics D* 27(14): 1846001
- Smolin, L. 2006. The case for background independence. In: *The Structural Foundations of Quantum Gravity*, eds. D. Rickles, S. French, and J.T. Saatsi. Oxford: Oxford University Press, pp 196–239.
- Stachel, J. 2014. The hole argument and some physical and philosophical implications. *Living Reviews in Relativity* 17(1): 1.
- Stachel, J., and M. Iftime. 2005. Fibered manifolds, natural bundles, structured sets, g-sets and all that: The hole story from space time to elementary particles. *arXiv preprint* arXiv:0505138.
- Stachel, J., et al. 2006. Structure, individuality and quantum gravity. In *The Structural Foundations of Quantum Gravity*. Oxford: Oxford University Press, pp. 53–82.
- Thorne, K.S., and R.D. Blandford. 2017. *Modern Classical Physics: Optics, Fluids, Plasmas, Elasticity, Relativity, and Statistical Physics*. Princeton: Princeton University Press.
- Wald, R.M. 1984. *General Relativity*. Chicago: University of Chicago Press.
- Wallace, D. 2010. Gravity, entropy, and cosmology: In search of clarity. *The British Journal for the Philosophy of Science* 61(3): 513–540.
- Weyl, H. 1922. *Space–Time–Matter*. US: Dover.

Chapter 6

Systemic Materialism in Biology



Rafael González del Solar

Abstract Modern biological science is one of the bulwarks of materialism, especially since the retreat of vitalism, the consolidation of the theory of evolution, and the discovery of the structure of DNA. Yet, there are still certain domains of biological research where idealism seems to resist materialistic arguments (and unfavorable evidence), sometimes as an advance of spiritualism, others as a reaction against strong forms of reductionism. While spiritualism may need a different kind of counterargument, the systemic view on biological entities provides a promissory approach for strengthening materialism without the drawbacks of radical reductionism (e.g., physicalism), especially in the studies of the origin of life and the nature of human mind. Indeed, systemic materialism is a kind of monism about substance, but it is pluralistic about properties: it does not claim that everything is physical, but that even though everything is material, some material entities (i.e., systems) possess properties that are out of the reach of physics. In this chapter I review the main traits of systemic materialism in biology.

6.1 Introduction

Philosophical materialism is the view that the world consists solely in and of material existents. Material (or concrete or real) objects are characterized by being changeable, i.e., by their having energy, the ability to change. Material existents are also called ‘things’. Conceptual (or ideal or abstract) objects, on the other hand, do not possess energy and thus cannot change. Conceptual objects are also called ‘ideas’ and their mode of existence consist in being part of a conceptual system. For the philosophical materialist, to really (or actually) exist amounts to be material (for details, see Bunge 1977, Ch. 3; Romero 2018, Ch. 3.; Romero in this book, Ch. 2).

R. González del Solar (✉)
Universidad Autónoma de Barcelona, Catalonia, Spain
e-mail: rafael.gonzalezd@e-campus.uab.cat

© Springer Nature Switzerland AG 2022
G. E. Romero et al. (eds.), *Contemporary Materialism: Its Ontology and Epistemology*, Synthese Library 447,
https://doi.org/10.1007/978-3-030-89488-7_6

According to one popular view, materialism equals physicalism, that is, the perspective that everything that exists is not only material, but physical. In a somewhat crude simplification, to the physicalist, all things are nothing but physical entities. This “nothing but” is, of course, the mark of reductionism. Yet that statement allows for at least two ontological interpretations depending on the meaning one gives to the term “physical”. One possibility is to understand that “physical” designates all material entities. The other that the term refers to all entities studied by the science of physics, a move that implies two ontological and one epistemological theses. The first ontological thesis (substance monism, or O_1) is that all existing entities are made of one substance, namely matter. The second ontological thesis (property monism, or O_2) states that all entities possess the same kind of properties, namely physical. The epistemological thesis (E_1)—which stems from O_1 and O_2 —is that the laws of physics suffice to explain the world, from the behavior of fields and quarks, to the origin of living cells and the behavior of human societies.

While O_1 is widely accepted among scientists and philosophers of science, O_2 and E_1 are rather controversial. In particular, E_1 is resisted by most scientists in the so-called special sciences that attempt to find scientific laws different from those of physics. In any case, the physicalist epistemological project has been and is still attempted, though with little success. Most of our chemical, biological, psychological, and sociological knowledge remains well out of reach of those scientists who try to explain everything by means of a handful of physical principles and laws. In fact, not even macrophysics seems reducible to microphysics if we are to judge from the success of the proverbial “theory of everything” project. A possible explanation of such failures is that O_2 is false, i.e., that matter can somehow acquire properties that are not physical and that those new properties are to be explained by non-physical laws.

In sum, modern materialism is a family of ontologies that share O_1 and may or may not share O_2 . Physicalism is just one subfamily of the materialistic family, one that can be roughly described as $O_1 + O_2 + E_1$.

A different member of the family is systemic materialism, more precisely emergentist systemic materialism, which differs from physicalism in the former being pluralistic about the properties of matter, while the latter is monistic all the way. In other words, emergentist systemic materialism denies O_2 in stating that it is necessary to distinguish between physical, chemical, biological, and social kinds of systems on the basis of the objective global properties that the systems of each kind possess (O_3). Those global properties emerge by assembly in each new kind of system or by reorganization in preexisting systems, and determine a number of levels of organization of matter. By denying O_2 , systemic materialism denies E_1 too and asserts the epistemological thesis that some facts in a given level ought to be explained by models that describe facts in the same level (E_2). The central concepts of this brand of materialism are, then, those of “system”, “global property”, “emergence”, and “level”.

6.2 System

As of August 2019, a cursory look at the contents of the Stanford Encyclopedia of Philosophy (SEP)—a widespread source of philosophical knowledge—will show the reader that no SEP article is devoted to the concept of “system”, let alone, that of “systemism”. In spite of this, an equally cursory search will make it clear that the term ‘system’ appears ubiquitously throughout the SEP. Indeed, talk of systems is commonplace in most scientific disciplines, and philosophical studies of science or related to science often reflect such fact. More often than not, when there is talk about physical, chemical, biological, social, or technological complex objects made up of things organized in specific ways, they are collectively referred as ‘systems’. Yet, with similar frequency, a precise definition of the “system” concept is lacking.

One of the most thorough efforts to offer an exact definition of the system concept is Mario Bunge’s systemism. The author offers a whole philosophical theory of systems in his *A World of Systems* (Bunge 1979), the fifth volume of the *Treatise on Basic Philosophy* (Bunge 1973–1989). The *Treatise* covers formal semantics, ontology, epistemology, and ethics, all treated in an exact manner and with intent of building a philosophical system. Here I will expound the author’s emergentist systemic materialism as introduced in *A World Systems* and further developments, especially in Mahner and Bunge (1997) and Bunge (2003, 2010).

6.2.1 What Is a System?

In order to distinguish systems, which are wholes, from mere aggregates of things, the former are sometimes referred to as complex objects that are “more than the sum of their parts” and that “have global properties that their components lack”. Indeed, those are characteristics of systems, but we surely need a more complete characterization. In a nutshell, a concrete¹ system is a complex thing (or composite) that behaves in certain aspects as a whole, and is made up of component parts that are organized in specific ways by virtue of their mutual relations and interactions, and those they establish with the environment in which the system is embedded.

In order to study a given system, then, it is convenient to pay attention to its four basic aspects, namely its composition (*C*), environment (*E*), structure (*S*), and mechanism (*M*). Thus, the minimal model for a concrete system σ will be a quadruple, $\sigma = \langle C\sigma, E\sigma, S\sigma, M\sigma \rangle$.

The *composition* of a system is the collection of all the parts that make up the system. For example, the composition of a tree, a biological system, is the collection

¹ Systems are either conceptual (ideal) or concrete (real). Since conceptual systems do not have energy, they cannot change and lack processes and, more specifically, mechanisms. As a consequence, a model of a conceptual system is a triple— $\sigma = \langle C\sigma, E\sigma, S\sigma \rangle$ —instead of a quadruple (Bunge 1979).

of its different organs, such as its roots, stems, leaves, flowers, and fruits. More often than not, the components of a system are systems themselves. For instance, the stem of a tree is composed of three tissue systems, namely the dermal tissue, the ground tissue and the vascular tissue. In turn, each of these three systems is composed of lower level systems, such as cells of different types. The systems that are component parts of higher level systems are called ‘subsystems’. Thus, each cell is composed of a variety of subsystems such as the cell wall, the cell membrane, the cytoplasm, and different organelle such as the nucleus, chloroplasts and vacuoles. Except for the universe, which is the ultimate system, all other systems are subsystems of at least one system (Bunge 1979). This nested array of systems and subsystems, a particular case of the whole–part relation, has several ontological consequences, one of them being the level structure or “hierarchy” of matter that will be discussed below.

The *environment* of a concrete system is the collection of things that are not part of the system, but act or are acted upon by the system of interest. For instance, the environment of a tree is composed of a diversity of abiotic and biotic objects and processes that affect that tree and are affected by it, such as the soil where the tree grows, water in its different states, luminous radiation, as well as other plants and animals connected to the tree by “ecological interactions”² (commensalism, mutualism, amensalism, parasitism, competition with other plants, or predation by animals). Systems connect to their environments through a diversity of processes whereby several kinds of matter and energy exchange take place. In other words, all systems, save the universe as a whole, receive inputs, and since systems always react on their environment, their output is never nil (Bunge 1979).

The *structure* of a system is the collection of relations among the different parts of the system (*endostructure*) and among those parts and the objects in the environment (*exostructure*). Relations are of two very different kinds, namely bonding ones and non-bonding ones. The characteristic feature of bonding relations, also called connections or couplings, is that they involve the action of at least one of the relata upon the other. In other words, two things are connected if the action of one thing modifies the history or trajectory of the other thing. Such action may or may not be a causal process, since it need not effectively produce a change in the relatum acted upon. It suffices that the action opens or cuts certain possibilities, i.e., that the action is causally relevant with respect to other processes. An example of an ecological bonding relation is the one between small shrubs and large neighbor trees located to windward in strongly sunny, strongly windy environments. Though there is no causal process connecting them, large trees facilitate the survival rate of smaller, less tolerant plants, seedlings, and shrubs in virtue of their spatial relation, by shielding them from excessive UV radiation, wind, and other potentially harmful processes (González del Solar et al. 2019). However, the relation of a tree merely being taller or larger than another plant constitutes a non-bonding relation, since such fact alone does not open or cut per se the possibility of shielding. In sum,

² Though this is the usual term for them, strictly speaking ecological “interactions” need not be genuine interactions nor even processes, it suffices that they make up bonding relations.

bonding relations make some difference to at least one of the relata by changing their trajectory or history, while in non-bonding relations relata remain unaffected by each other.

Finally, the *mechanism* of a given system is the collection of specific processes involved in the emergence, maintenance, modification, and disintegration of the system of interest. For instance, the process called photosynthesis is the mechanism through which some organs—i.e., subsystems such as chloroplasts—in photoautotrophic plants produce high energy chemical compounds by using water, inorganic nutrients, and luminous radiation as raw materials. Another example is interference competition, an ecological mechanism of biodiversity. Interference competition consists in a network of processes—most of them causal—in which an organism directly prevents another organism from benefiting from a resource by attacking the latter or chasing it away.

Note that the CESM strategy is a philosophical approach that provides qualitative representations of systems. Scientific models of systems, on the other hand, may be qualitative (as is the case of Boudon–Coleman diagrams, see Bunge 2003), but are usually quantitative, especially in the natural sciences. Moreover, unlike scientific dynamic models, CESM models do not include the laws that bound the behavior of the system or its parts. As a consequence, CESM models are only the first step in building scientific theories and models of systems, as well as a reminder that in order to understand a system we need to pay attention not only to the composition of the system and the interactions among its parts, but also to the relations and processes connecting the system with its environment.

Note that systems are not all equally integrated or tightly knit. For example, an individual tree is a rather integrated system, while an ecological community, still being a system, is less structurally tight than its components. Indeed, there are degrees of cohesion, integration or systemicity, a magnitude that depends on the connections or links among the components of a system relative to the actions of the environment that tend to disintegrate such system. As the inner couplings of the system go stronger, the degree of cohesion goes higher. In a large number of physical, chemical and biological systems, the degree of integration can be measured by their binding energy, i.e., the minimal energy needed to dissociate a system into its components. Atomic binding energy, ionization energy, and bond dissociation energy are some examples in physics and chemistry, while bond dissociation energy is relevant for certain biological systems, such as plant stems. However, this measure is not applicable to systems in which information links are at least equally important, such as social systems. (More on system's degree of integration in Bunge 1979: 35 ff).

Note also that while systemicity is a structural property of a system, one can also focus on the functional property of coordination. Two or more components or links may be said to be coordinated if they jointly contribute to the integrity of a system. Thus, integrity precedes, but needs not, coordination.

Systemic materialism is monist with respect to substance, but pluralist with respect to properties. In other words, it assumes that not all properties are physical. Indeed, a central assumption of the approach is that there is qualitative novelty in the

world—i.e., properties and systems of new kinds—and that such novelty emerges from the organization of the component parts of systems, that is, from their structure and mechanism. This is why systemic materialism is emergentist.

6.3 On Emergence

Though there is some evidence that Galen and some other important thinkers, such as John Stuart Mill, were emergentists, it is widely acknowledged that ‘emergence’, as a philosophical term, was first used by George H. Lewes in his 1875 book *Problems of life and mind* (O’Connor and Wong 2015). Lewes distinguished between *resultant properties* and *emergent properties*. The resultant properties of a system are those that also the components of the system have.

For example, the property of being alive is both a property of the living organism and a property of the cells that make up such organism and thus, it is a resultant property of organisms relative to cells. In contrast, the components of the living cell lack the latter’s property of being alive. Lewes called emergent properties those global properties of systems that their parts lack. In a nutshell, emergence is an outcome of a collection of assembly and reorganization processes that involve qualitative ontological jumps, and we know about those jumps thanks to our possibility to assess the occurrence of global properties in systems, absent from their component parts.

Mahner and Bunge (1997: 30, italics in the original) provide the following definition of an emergent property:

Let P represent a property of a thing b . P is an *emergent* property of b if

- (i) b is a complex thing (a system), no component of which possesses P ;
or
- (ii) b is a thing that has acquired P by virtue of becoming a component of a system (i.e., b would not possess P if it were an independent or isolated thing).

Thus, an important characteristic of emergence processes is that they can bring about two types of emergence, (i) intrinsic (or global) and (ii) relational (or structural or contextual). *Intrinsic emergence* is the process by which a new system comes to existence or acquires a new property. *Relational emergence* is the process by which a thing acquires new properties by becoming part of a system. For example, the property of being alive is a case of an intrinsic, or global, emergent property of cells and of virus–host systems. In contrast, being a parasite, a host, a predator, or a prey are all four contextual emergent properties.

A system may gain or lose some emergent properties in virtue of certain processes. We already dubbed the former processes of emergence, and the latter may be called *processes of submergence*. Since the concrete way of gaining and losing emergent properties is dependent on the particular case, there are myriads of different processes of emergence and submergence. Thus, the self-assembly processes that lead to the emergence of living systems—i.e., mechanisms of reproduction—in bacteria, algae, and mammals are rather varied. Furthermore,

such assembly processes are very different from those that lead to the emergence of, say, water molecules from precursor atoms or calcite crystals from precursor molecules of calcium carbonate. Reorganization processes, such as those that insects undergo throughout development are also a source of emergence and submergence of properties. For example, as most butterflies, the imago of the Eurasian swallowtail (*Iphiclides podalirius*) has wings that allow it to fly. This ability to fly, an emergent property of adults, is absent from the larvae (caterpillars), which are wingless. In turn, those larvae possess mandibles that allow them to eat leaf tissues, a property that submerges with the tissue reorganization that takes place during the pupa stage and is absent from the adults, which can only take liquid nutrients through a proboscis.

Emergent properties and systems can also be *absolute emergents* if the qualitatively new system or properties have never existed before—i.e., if they belong to a radically new kind—or *relative emergents* if such novelties are new only for the particular things (precursors or systems) involved in the emergence processes, but those novelties do not belong in a radically new kind. For example, macroevolutionary processes may produce absolute emergents when the result of those processes is an individual or group that belongs in a new biological taxon. In contrast, the ontogenetic processes that produce wings and the ability to fly in swallowtails bring about relative emergents.

6.4 Levels

Assembly processes also determine levels of organization of matter. A level of organization, or integrative level, is a collection of objects that share some properties, especially some laws. The basic idea of an integrative level comes from the nested array of systems and subsystems, and is rather straightforward, at least to biologists: systems at a given level are composed of things in lower levels.

Components take ontological precedence regarding the systems they form. For example, a Mediterranean forest is an ecological level system composed of individuals of several species of trees, all of them individual level systems, which, in turn, are composed of organs and tissues (organ/tissue level) which, in turn, are composed of cells (cell level) composed of organelles (subcellular level), composed in turn of biomolecules (molecular level), and so on. In general, scientists distinguish five main levels of organization: physical, chemical, biological, social, and technical, though each of those levels can be analyzed in as many sublevels as necessary, as in the example of the Mediterranean forest above. Usually, two (macro- and microlevels) or three (by addition of a mesolevel) will suffice in a research project.

Take, for instance, the problem of explaining the spatial association of certain shrubs and larger trees in a particularly harsh grassland–forest ecotone of the Rocky Mountain Front (Baumeister and Callaway 2006). The explanation proposed invokes causal processes and bonding relations in at least three levels. A macrolevel

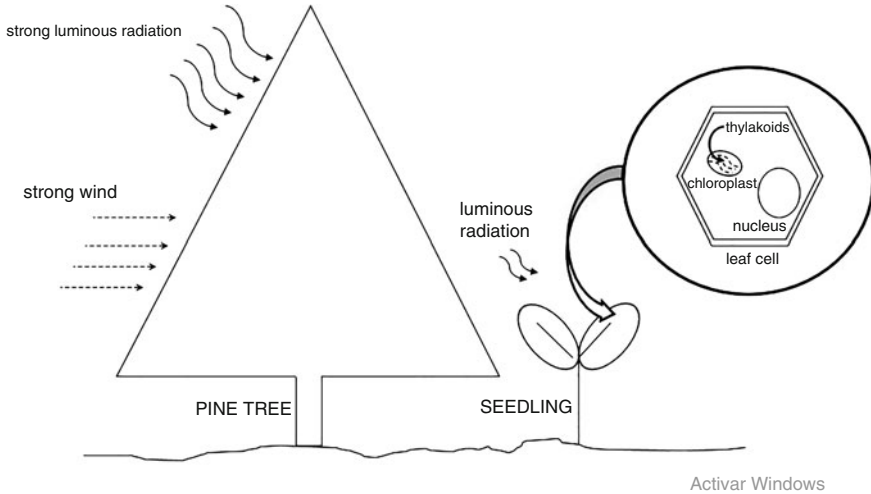

Fig. 6.1 Processes and bonding relations in at least three levels of organization are necessary to explain the facilitation of seedling survival by pine trees. Macrolevel (bonding spatial relation between pine trees and seedlings), mesolevel (conserved physical integrity of stem and leaf tissues), microlevel (photosynthetic processes in the thylakoids of chloroplasts in leaf cells, etc.)

(ecological community level), represented by the peculiar (bonding) spatial relation between wax currants (*Ribes cereum*) and Douglas firs (*Pseudotsuga menziesii*) on one side, and the larger stress-tolerant limber pine (*Pinus flexilis*) on the other. A microlevel (molecular level), represented by a variety of causal processes, among them photoinhibition, i.e. the light-induced depression of photosynthetic rate in chloroplasts, produced by an absorption of photoactive radiation higher than that the plant can effectively use. One mesolevel (tissue level) represented by the abrasive impact of windborne dust and ice particles on the epidermal tissue of the plants involved in the study (Fig. 6.1).

Being sets, integrative levels are concepts, not things, therefore they cannot act on things nor be acted upon by them. Instead, levels may be related by precedence based on the part-whole relation of systems. One level precedes another if all things in the latter are composed of things in the former. More precisely, systems occur in nested hierarchies, where systems in one level of organization are composed of (sub)systems in lower levels. In the facilitation example things in the community level are composed of things in the individual level, which in turn are composed of things in the tissue level, and so on and so forth. Integrative levels are concepts, indeed, but the nested array of matter they represent is not ideal, but factual.

6.5 Emergence and Supervenience

Ontological emergence is still far from being generally accepted by the philosophical community. Perhaps its past, related to some varieties of holistic vitalism opposed to scientific analysis and reductive explanation, has made the notion of emergence suspect to thinkers with a strong empiricist leaning. In fact, that life is emergent—i.e., that it transcends the physicochemical level—is one of the contributions of the defunct vitalist project to study life. Emergentists took the concept of emergence from vitalists seeking to build a middle ground between the two main views on life, namely mechanism and vitalism. The general idea was to throw the water of a vital substance without throwing the baby of the qualitative novelty of life.

Be this as it may, there is nothing mysterious about ontological emergence, since it does not imply the impossibility to explain qualitative novelty—as is sometimes thought—nor provides an excuse for accepting dubious entities or processes. Bonds and mechanisms are the key to explaining emergence, since they are the relevant conditions that make possible and the specific processes that bring about—and, thus, jointly explain—the emergence of new systems and new properties.

Note that emergentist systemism has an important epistemological consequence, namely that for all its successes, reduction has its limits. Such limits are imposed by the level structure of reality. Though levels of organization are not real they are objective in the sense that they represent qualitative jumps in the fabric of reality. Since levels represent—and thus refer to—real features of the world, and objectivity can be defined as reference to items in the external world, levels of integration are objective (see, e.g., Bunge 2003). More precisely, levels of integration identify the boundaries of the domain of certain natural laws, and of certain properties and systems that their subsystems lack. For example, though physical laws apply across all levels of organization, such laws cannot explain strictly biological facts such as macroevolutionary change, i.e., the origin of biological “species”. An explanation of this fact requires strictly biological laws, namely those that make up the theory of biological evolution. In general, theories that belong in three—i.e., chemical, biological, social—of the five main levels mentioned above are not reducible to theories in the lower levels, a thesis that justifies the assumption that the special sciences are to be considered autonomous from physics.

Yet, there is another notion that relates to the idea that matter is organized in a levels structure that is less ontologically committed than the notion of emergence, namely that of supervenience. Regarded by some as a central notion of analytic philosophy (McLaughlin and Bennett 2018), supervenience is usually characterized as follows: “A set of properties A supervenes upon another set B just in case no two things can differ with respect to A-properties without also differing with respect to their B-properties”.

One of the problems with the idea of supervenience is that it seems to assume the existence of properties in themselves. In contrast, processes of emergence are always described as concrete processes occurring in things. Another problem of

supervenience is that, if analyzed as a static logical relation, supervenience is bijective and in this case is symmetric, and as such it can only describe correlations between properties in two levels. In contrast, processes of emergence are always described dynamically, along a time axis that establishes precedence of some things (precursors) over other things (systems). (For more criticisms on the notion of supervenience see Mahner and Bunge (1997) and Bunge (2010).

6.6 Biosystems

Biological systems (biosystems, living systems or living organisms) are of course systems characterized by being alive. There are currently several families of projects trying to answer the question What is life? Among those projects are the physicochemicalist, the Artificial Life (or A-Life), and the emergentist ones (Weber 2018). In the nineteenth century and the beginnings of the twentieth century there was another contender, vitalism, which saw life as an entity of sorts, a substance or force, such as Bergson's *élan vital*. The vitalist project may have been justified before the advent of the biochemical conception of life, but it has been largely abandoned in favor of the three families of projects previously mentioned, in part due to the success of mechanism in showing the relevance of physical and chemical process in the emergence of living organisms, in part because the substance of life has never been found. In any case, vitalism left two important contributions to ontology, namely (a) the already mentioned concept of level of organization included in the thesis that the biosphere has a level structure going from cell to organ to organism to population to ecosystem, and (b) the principle, embodied in the notion of emergence, that life transcends the physicochemical systems and laws (Bunge 1979).

The physicochemicalist view of living organisms emphasizes composition and understands the living cell as a complex machine with exclusively physical and chemical properties and laws. In doing so, physicochemicalism denies the emergent quality of life and usually stresses the importance of DNA over other components of the living body. However, DNA cannot even be considered a truly genetic material without the relevant enzymes (proteins) that make possible the activation and deactivation of genes, as well as other components of the living cell. This is why virus cannot reproduce themselves without infecting a living cell and are not considered to be living beings on their own. In any case, physicochemicalism has contributed two important ontological hypotheses to the study of life: (a) that life emerged by the self-assembly of macromolecules, and (b) that some physical and chemical mechanisms and laws continue to operate in living organisms.

A-Life puts the focus of research on the processes—especially on information ones—that occur in living things rather than in their components. Thus, A-Life explores not only life in biosystems, but also “in silico”. Since these are not living systems and it is too soon yet to know the possible contributions of this project to our understanding of biological systems (Weber 2018), I shall not elaborate on this.

The emergentist systemic conception of living organisms—i.e. biosystemism—takes the two principles contributed by vitalism and the two hypotheses of physico-chemicalism and supplements them with three principles of its own: (a) that organisms are systems with emergent properties and are composed of biochemical subsystems, (b) that every level has its own laws, and (c) that the units of biological study are the organism-in-its environment and its various subsystems (molecules, cells, organs) and supersystems (population, ecosystem, biosphere) (Mahner and Bunge 1997).

Biosystemism handles the problem of the emergence of life following Aleksandr Oparin's hypothesis that abiogenesis, that is, the primordial emergence of living cells, was a processes of self-assembly of non-living macromolecules. Moreover, for the biosystemist, the components of a cell are not alive—they belong to the physicochemical level—but they self-organize in specific ways unknown to physics and chemistry that give rise to new systems with qualitatively novel properties, i.e. biosystems. Bunge (2003: 46) characterizes a biosystem in terms of “a semi-open material system far from thermodynamic equilibrium with its environment, whose boundary is a semi-permeable lipid membrane” whose composition, structure, environment, and mechanism satisfy certain specific conditions:

1. the *composition* of the system equals a collection of physical and chemical micro- and mesosystems including water and certain organic molecules, such as carbohydrates, proteins, lipids, and nucleic acids;
2. the system's *environment* is a medium in which nutrients and energy fluxes are available and whose variables (such as temperature, radiation, pressure, and acidity) are confined within certain relatively narrow intervals;
3. the *structure* of the system is a collection of physical and chemical bonds that interconnect the components of the system and thus keep the latter together, plus all the couplings—physical, chemical, and biological—of the system with items in its environment;
4. the *mechanism* of the system is the collection of processes of growth, maintenance, and self-repair that keep the biosystem alive, among them, all those involved in the activation and deactivation of genes, the synthesis of a diversity of molecules, the transport, rearrangement, assembly, and dismantling of different components related to metabolism, and the transport of chemical and electrochemical signals of various kinds.

Biologists have characterized living systems by means of a collection of inter-related properties that chemical and physical systems lack. What we call 'life' is precisely that collection of properties. Therefore, while biosystems—i.e., living organisms—are real, “life” is not a thing nor a property, but a concept whose reference is a collection of properties possessed by living systems, namely:

Cellularity: the property of being a cell or being composed of cells embodied in the biological principle that the basic unit of life is the cell, i.e., a system endowed with a semipermeable membrane that possesses all the properties in this list. According to this, there is no life under the cellular level of organization. This, of course, leaves out of living matter certain things that seem to be borderline cases, such as viruses.

Metabolism: this is the collection of processes by which the organism transforms environmental resources (nutrients and energy) in components for growth and development, as well as in high energy compounds for fueling such processes.

Homeostasis: this is the ability to maintain a relatively constant internal milieu, especially regarding temperature, acidity, and bodily fluid balance, by means of a variety of control mechanisms, such as negative feedback processes.

Cell division: this is, of course, a process whereby a cell divides in two or more daughter cells that can be genetically identical (mitosis) or different (meiosis) to the mother cell. The process involves the splitting and replication of a molecule of DNA by enzymes. Though all living organisms undergo cell division, not all cells in one particular organism end up dividing themselves, as is the case with most neurons.

Heredity: this is the ability of self-reproducing organisms to pass some of their traits to their offspring. Such ability is based on the properties of genetic material, especially the DNA molecule, which is capable of replication. Though DNA replication is rather faithful, it is not perfect, since the molecule is sensitive to some strong environmental factors, such as certain types of radiation and chemical compounds. By the way, the immediate environment of a DNA molecule is the nucleoplasm, where the enzymes responsible for DNA splitting are dissolved.

Evolution: this is the collection of processes by which living organisms change and some variants end up being better adapted to their environment than others. While evolutionary theory is being constantly revised and perfected, there is agreement among biologists that evolution results from the concurrent operation of mutation, environmental selection, niche construction, hybridization and a few other mechanisms present at all levels of organization, from cell to population to community. A consequence of this is that there is not one but several units of evolution. Biomolecules, such as DNA can evolve because they replicate with variation (genic mutations), and are subject to environmental selective pressures, but also individuals evolve because they replicate with variation (genetic and ontogenetic changes) and are selected by the environment.

Populations—systems composed of individuals of the same biospecies—and ecosystems—systems composed of populations of individuals of different biosystems—also evolve, but in a vicarious way, because they do not undergo genic changes. In sum, biosystemism is the view that there is no life beyond living systems and that biosystems differ from physicochemical systems in that the former possess the system of interrelated properties mentioned above.

6.7 Psychobiosystems

Being monist with regard to substance, biosystemism rejects the idea of an immaterial mind. In its stead psychobiosystemism holds the psychoneural identity hypothesis, which states that the mind is no substance, but a collection of very special brain processes. Being pluralist regarding properties this view states that mental properties are emergent properties of such brain processes.

Indeed, according to psychobiosystemism, what we call ‘mind’ is analogous to what we call a ‘smile’ in that there is no particular substance that we call a smile. There is no smile apart from the particular arrangement of facial components and their interactions. In fact, what we call a ‘smile’ is a particular collection of processes in the human face, a part of the human body that happens to have the ability to smile. Thus, faces are not the “material substratum” of smiles, just as faces do not “subserve” nor “instantiate” smiles. There are no smiles in themselves, only smiling faces. Likewise, mind is not a product of the brain activity in the same sense that smiles are not a product of the activity of the face. Mind is one of many brain activities, just as smiling is one of the many activities of a face.

Though some form of the psychoneural identity hypothesis can be traced back to Galen and even to the Ancient Greeks Alcmaeon of Croton, Hippocrates and the materialists Democritus and Leucippus, in its modern form the hypothesis seems to have been postulated by U. T. Place’s 1956 article “Is Consciousness a Brain Process?” (Smart 2017). There are roughly two families of answers to this question. One of them is psychoneural dualism, the view that there are two substances, the body (matter) and the mind, that somehow interact. The other family is psychoneural monism, which holds the aforementioned psychoneural identity hypothesis, which is strengthened by a number of scientific findings that suggest an intimate connection between brain processes and mental processes. For example, the effect of hormonal changes in the individual’s mood, the loss of memory with neuronal damage in Alzheimer’s disease, the effect of experience in cortex organization, the effect of chronic stress on the health of various organs mediated by the neuroendocrine system, and so on.

True, these findings cannot discard the variety of dualism called interactionism, which holds that body and mind causally influence each other. Yet, there are two important objections to interactionism, namely that there are no hints of how such interaction could occur and that it violates a fundamental scientific law, that is, the conservation of energy principle. Indeed, causal interactions involve energy transfer, so if such interactions between body and mind were the case, energy would be flowing in and out of the body and would not be conserved (but see Robinson 2017). Neither those findings have the power to exclude the variety of dualism called epiphenomenalism. This is the view that mental events are caused by neural events, but have no causal influence on the latter. The causal relation that epiphenomenalism invokes is no less mysterious than that invoked by interactionism. Plus, it cannot explain the influence of mental events, such as emotional stress, on the body, not to mention that of conscious states, such as perceptions of danger, on certain behaviors such as danger avoidance, whose evolutionary advantages are difficult to doubt.

If the organ of the mind is the nervous system, in order to understand the mind, we need to study the nervous system, especially (though not only) the brain. So far, we know that it possesses peculiar properties and functions that make mental processes possible. Some of these properties are the *spontaneity* (independence from stimuli) of neuron activity, *lateral inhibition* (limited propagation of excitation), *grouping of neurons into systems* with specific emergent properties, *functional*

differentiation and relative independence of some neural subsystems, and the *plasticity of certain cortical subsystems* (Bunge 2003).

Now, not all brain processes are mental. The brain is a complex organ composed of cells of different kinds, such as neurons and various glial cells, that perform different functions, and only neurons are directly involved in mental functions. In fact, not all the neurons in the nervous central system can undergo mental processes, but only some neural subsystems of the brain. Put more precisely, psychobiosystemism postulates that “the mind of an animal during a given period is the union of all specific functions (processes) occurring in the plastic part of its nervous system during that period” (Bunge 2003: 52). The smallest plastic neuronal system capable of discharging a mental function may be called a *psychon*, so minding is what psychons and systems of psychons do. (Bunge 1979). The plasticity of a neural subsystem is its ability to alter—either strengthening or weakening—neural connectivity. This property is rooted in such subcellular processes as changes in gene expression and dendrite sprouting and pruning (Bunge 2003). An animal that lacks neural systems at all or whose neural system do not include plastic subsystems—i.e., psychons—lacks a mind.

One consequence of the systemic nature of mental functions is that while the components of the subsystems with the ability to undergo mental processes—i.e., psychons and systems of psychons—are all neurons, their environment is a complex net of bodily systems that affect and are affected by such mental processes. Some of those systems are other brain subsystems. One is the glial tissue, which participates in such essential processes as synaptogenesis, synaptic plasticity, neurotransmission, neural maintenance and repair, and the formation of the myelin sheaths of axons. Other brain subsystems linked to psychons in the cortex are the phylogenetically older neural centers, such as the amygdala and the hippocampus, that are primarily involved in affective behavior and memory. This is why there are no pure mental processes. All of them, from memory to cognition, are always ‘colored’ by a diversity of neural and non-neural processes in the body. Moreover, the brain is not an autonomous organ, but is intimately connected with other bodily systems such as the endocrine, the immune, the cardiovascular, the digestive, and the musculo–skeletal systems. This is one of the reasons why in order to understand the mind (i.e., mental processes) we need to study the nervous system, but also its connections with the other bodily systems that make up its environment. Furthermore, we also need to add to our study the ways in which social interactions affect mental functions.

6.8 Concluding Remarks

To sum up, the systemic view of the world holds that everything that really exists, including the universe, is a material system or a part of a material system. Systems are complex wholes that possess global properties their components lack. Besides being made up by component parts, systems possess a structure, undergo a variety

of processes and are immersed in an environment, all of which are relevant for understanding their emergence, maintenance, changes and eventual disintegration. The global properties of a system are qualitative novelties from an ontological point of view and emerge in the course of specific processes of assembly or reorganization, that is, through mechanisms.

Living organisms are biosystems, that is, systems endowed with a system of characteristic properties that include cellularity, metabolism, homeostasis, cell division, heredity, and evolution.

Some biosystems possess nervous plastic subsystems—i.e., psychons—with the ability to perform mental functions. Since psychons and systems of psychons interact with other bodily systems, as well as with items in the environment of the individual (among them, other individuals of the same species), the study of mind requires the study of systems and processes at different levels of organization, from the molecular level to the cell level, and from the organ level, to the individual and the social levels.

References

- Baumeister, D. and R. Callaway. (2006). Facilitation by *Pinus flexilis* during succession: A hierarchy of mechanisms benefits other plant species. *Ecology* 87(7):1816–1830.
- Bunge, M. 1977. *Ontology I. The Furniture of the World*. Dordrecht: Reidel Publishing Co.
- Bunge, M. 1979. *Ontology II. A World of Systems*. Dordrecht: Reidel Publishing Co.
- Bunge, M. 2003. *Emergence and Convergence. Qualitative Novelty, and the Unity of Knowledge*. Toronto: University of Toronto Press.
- Bunge, M. 2010. *Matter and Mind. A Philosophical Inquiry*. Boston Studies in the Philosophy of Science, Vol. 287. Dordrecht: Springer.
- González del Solar, R., L. Marone, and J. Lopez de Casenave. 2019. Mechanistic approaches to explanation in ecology. In *A Centenary Festschrift*, ed. M. Mathews, 555–573. Cham: Springer.
- Mahner, M., and M. Bunge. 1997. *Foundations of Biophilosophy*. New York: Springer.
- McLaughlin, B., and K. Bennett. 2018. Supervenience. In *The Stanford Encyclopedia of Philosophy* (Winter 2018 Edition), ed. Edward N. Zalta. <https://plato.stanford.edu/archives/win2018/entries/supervenience/>.
- O'Connor, T., and H.Y. Wong. 2015. Emergent properties. In *The Stanford Encyclopedia of Philosophy* (Summer 2015 Edition), ed. Edward N. Zalta. <https://plato.stanford.edu/archives/sum2015/entries/properties-emergent/>.
- Robinson, H. 2017. Dualism. In *The Stanford Encyclopedia of Philosophy* (Fall 2017 Edition), ed. Edward N. Zalta. <https://plato.stanford.edu/archives/fall2017/entries/dualism/>.
- Romero, G.E. 2018. *Scientific Philosophy*. Cham: Springer.
- Smart, J.J.C. 2017. The mind/brain identity theory. In *The Stanford Encyclopedia of Philosophy* (Spring 2017 Edition), ed. Edward N. Zalta. <https://plato.stanford.edu/archives/spr2017/entries/mind-identity/>.
- Weber, B. 2018. Life. In *The Stanford Encyclopedia of Philosophy* (Summer 2018 Edition), ed. Edward N. Zalta. <https://plato.stanford.edu/archives/sum2018/entries/life/>.

Chapter 7

Mind and Matter



Íñigo Ongay de Felipe

Abstract This chapter is an in-depth examination of the various very convoluted philosophical issues that arise from the interconnection between the ideas of mind and matter. First the chapter critically examines the state of the art in the domain of the philosophy of the mind by approaching an array of different theories regarding the relationships between these two notions. While some accounts interpret this relationship in a reductive manner, whatever the specific direction of the reduction may be (from eliminative materialism to physicalism to pan-psychism) other approaches have very controversially insisted on the impossibility to explain away the so called “hard problem” of consciousness. There are still other doctrines that tend to understand the connection between mind and matter in a more systemic fashion by employing the ideas of emergence and complexity. While there is no denying that there exist philosophical merits to all these positions to various degrees, the point that the chapter makes is that they all come with insurmountable conceptual difficulties as well. The second part of the chapter advances an alternative framework inspired by the ideas of the Spanish philosopher Gustavo Bueno that, while avoiding the limitations of the various approaches considered, highlights the ways in which the notions of mind and physical matter can be accorded their proper roles without mutual reductionisms and without the resource to the very problematic idea of emergence.

7.1 Mind and Matter in a Philosophical Focus

The discussion about the relationship between mind and matter, most commonly known of as the mind–body problem, represents one of the acutest and most enduring debates throughout the history of philosophical thinking. The number

Í. O. de Felipe (✉)
University of Deusto, Bizkaia, Spain
e-mail: inigo.ongay@deusto.es

© Springer Nature Switzerland AG 2022
G. E. Romero et al. (eds.), *Contemporary Materialism: Its Ontology and Epistemology*, Synthese Library 447,
https://doi.org/10.1007/978-3-030-89488-7_7

215

of classics that have entertained contrasting conceptions about the issue is as multitudinous as it is outstanding in terms of the names of the figures any not-so-exhaustive list would have to encompass. From Plato to Aristotle, to Descartes, Leibniz, Spinoza, Locke, Hume, Berkeley, Hegel or Bertrand Russell, to name but a few, myriads of the most egregious figures in the history of Western thought have devoted some of their efforts to elucidate the intricacies of the puzzle in various ways. While many of the arguments designed over the course of the philosophical tradition have remained verbal in fundamental ways, more recent discussions of the problem tend to revolve around a purportedly more precise reconsideration of the issue in light of some of the contemporary developments in such scientific fields as neurophysiology, computational sciences, evolutionary biology, ethology and animal behavior, theoretical biology and so on. However, although there can be no doubt that these and many other areas of scientific endeavor are pivotal to any sound framing of the problem, other authors have insisted that there is an explanatory gap (Levine 1983) between modern science with its naturalist assumptions and the nature of consciousness in humans and other animals. For example, David Chalmers (1997) among others, controversially points to the inescapable irreducibility of the subjective character of qualia when thinking about the *hard problem of consciousness*. If this were so, it would entail that, however surprising this may seem for the modern *koiné* of methodological naturalism (Quine 1961; Churchland 1980; Dennett 1991), the philosophical problem of the relationship between mind and matter is one that escapes treatment by the methodology of current science the way it is understood nowadays. This is a point that Thomas Nagel (2012) argued in a fashion as defiant as it is controversial.

It is also worthwhile to consider that, as is frequently the case in relation to a number of other important philosophical problems, the answers to the mind–body question come in groups both in terms of what they affirm and, equally importantly, in relation to what they deny. While some replies have classically advocated the thesis of *dualism* in any of its multiple forms, others have fallen into the broad category of *monism*, including a variety of versions of *physicalism*, *eliminativism*, *mind–brain identity theory*, *functionalism* and the like. As different as these conceptions may seem when their details are considered, there is at least one feature they all share in common: they all try and explain the peculiarities of the mental by studiously reducing it to the physical either ontologically or epistemologically. As it will be shown, there appears to be some attractiveness to this negative solution of the problem given the shortcomings of substance dualism.

There are forms of naturalistic monism of more recent vintage that do not appeal to the idea of reduction. What they do instead is to begin by considering the levels of ontological complexity to be found in the universe the way it is described by the different branches of science and then to treat the *mental level* as an *emergent* property of certain biological organisms equipped with neurological systems. The point will be argued, however, that whatever the pitfalls of other alternatives, such a move, far from solving the problem, displaces the explanatory question to another place and in so doing it creates very many other problems of its own.

Although toward the end of the chapter some more positive proposals will be presented, the primary aim of this contribution is not to take sides in this important debate. More modestly, my objective is rather to step back to sift and winnow. I will start by identifying the most salient categories into which the plurality of theoretical conceptions of the relationship between mind and matter has fallen over time. In this regard, I will proceed by reconstructing the logical incompatibilities between the various ways to address the issue as well as exploring the systematic difficulties that they all have invariably tended to encounter down the road. The point will be made that there is something such strains do indicate: while all these alternatives are often right in what they critically say about one another, they all prove equally flawed with regard to their positive tenets about the issue at hand itself. At this point a pinch of *docta ignorantia* is sometimes worth taking. I will do more than that, however: rather than restricting itself to a call to skepticism or a pledge for prudence, the chapter also shows that the ultimate reason for such weaknesses lies in the irreparable tendency these alternatives exhibit to hypostatize either *the mind*, *the physical matter*, or *sometimes both*. In the face of such tendency, I believe that what is really key for any materialistic account of the mind–body problem and other collateral issues in philosophy of mind is to resist the urge to invoke any fundamental level of ontological unity and epistemological integration when thinking about a world that is irreparably pluralistic in nature. Here is the take-home message: in this matter as well as in a plurality of other philosophical concerns, if metaphysics¹ is to be avoided, it is well to start by stopping thinking metaphysically about the unity of the universe as if such postulate were a sound ontological proviso.

7.2 The Problem of the Two Substances: A (Very) Brief Introduction to Substantial Dualism

Although Pythagoras, Plato and Plotinus among the Greek and Augustine of Hippo among the Christians argued for an array of dualistic doctrines regarding the relationship between the mental and the physical, it is perhaps R. Descartes who offers the most standard version of the modern ontological framework that has gone by the label of *substance dualism*.² In the sixth of his *Meditations on First*

¹ Although the word metaphysics has been understood in an array of ways, in this context I use the term not to refer to the philosophical discipline about what there is but a general tendency within a multitude of ontological doctrines to treat as a substance what in actuality is a process. For more on this see Bueno (1972).

² As it is generally known in his *Meditations* as well as in other works (singularly in the *Discourse on the Method*) Descartes argues that even if speaking properly it is only the Infinite Substance (i.e. God) that meets the criteria for being recognized as a substance so long as only God, and not the Soul or the Body, is ontologically independent, both Mind and Body can however be understood as substances, albeit in a secondary and more improper sense, in that they are independent from each other although they depend on God both essentially and existentially.

Philosophy Descartes advances his account of the mind as an immaterial thinking thing that exists with independence of the material world. Here is how Descartes isolates his point about the dichotomy between the *res cogitans* and the *res extensa*:

But now, when I am beginning to achieve a better knowledge of myself and the author of my being, although I do not think I should heedlessly accept everything I seem to have acquired from the senses, neither do I think that everything should be called into doubt. First, I know that everything, which I clearly and distinctly understand, is capable of being created by God so as to correspond exactly with my understanding of it. Hence the fact that I can clearly and distinctly understand one thing apart from the other is enough to make me certain that the two things are distinct, since they are capable of being separated at least by God. The question of what kind of power is required to bring about such a separation does not affect the judgment that the two things are distinct. Thus simply by knowing that I exist and seeing at the same time that absolutely nothing else belongs to my nature or essence except that I am a thinking thing, I can infer correctly that my essence consists solely in the fact that I am a thinking thing. It is true that I may have (or, to, anticipate, that I certainly have) a body that is very closely joined to me. But nevertheless, on the one hand, I have a clear and distinct idea of myself. Insofar as I am simply a thinking non-extended thing; and on the other hand I have a distinct idea of body, in so far as this is simply an extended, non-thinking thing. And accordingly, it is certain that I am really distinct from my body, and can exist without it.³

Leaving its theological disguise aside, what this line of argument seems to suggest is that mind and body constitute two distinct substances independent from each other since they themselves and their respective essential properties can be clearly and distinctly understood conceptually in mutual isolation. If this were the case, so does Descartes seem to assume, what this conceptual separation would entail is a real ontological split between two substances, with the conclusion that the mind would then be an independent thing able to operate and even to exist without the concurrence of the organismal body. It is worthwhile to see that there is an interesting parallel to be drawn here with the ontological argument for God's existence in that the assumption underlying this form of mind-body dualism is that whenever something can be conceived of independently from something else a real substantial distinction must follow. It is not however this very questionable assumption I will have quarrels with here. Instead, the point I want to make is more direct: given the best neurophysiological evidence we have marshaled over the last two centuries of scientific development, it is rather doubtful to say the least, that any mental process, whatever properties one may desire to assign to it, can in fact be thought of coherently as independent from the corresponding brain states. The illusion that they could be so conceived is the end result of mistakenly taking what is dissociable in terms of their phenomenological properties with what is effectively separable in a substantial manner. In other words, whatever the other merits of Descartes' characterization of the mind and its phenomenal properties,

³ Descartes 2017a (1641), p. 61–62.

when it comes to substance dualism one does well to realize that this doctrine does indeed constitute a reification of the mind.

But what is wrong with reifying the mind? Let me note two different pitfalls of this idea. First, the point remains that if this type of dualism was correct, that would left unexplained the extensive amount of research about the location of psychological functions on the different brain areas, the effects of neuroplasticity in learning and behavior formation (Rosenzweig 1962; Wollett 2011), the chemical influence of neurotransmitters, drugs and social hormones on the etiology of a diversity of mental conditions as well as on the production or extinction of various behavior patterns (Pedersen and Boccia 2003; Feldman et al. 2007; Morhenn et al. 2012; Auyeung et al. 2009) the impact of anatomical and physiological alterations in the hippocampus on an array of impairments of both procedural and episodic memory (Campbell and Conway 1996; Parkin 1996), the role of mind and behavior within the evolutionary process as studied by ethology and evolutionary psychology (Striedter et al. 2012; Stephen et al. 2014) and plenty more. Under such conditions the only way dualism could possibly account for this far-reaching degree of scientific findings is by means of appealing to a millionaire multitude of ad-hoc miraculous correlations (Malebranche 1980) or to a rather uncanny divine pre-established harmony (Leibniz 1965).

In the face of these undeniable imbrications between the mind and the body, Descartes (2017b) offers a well-known account of how the *res extensa* and the *res cogitans* may after all interact causally with each other while staying substantially distinct and more importantly lacking the communality of properties that would allow for such reciprocity of causation. The *crux of the matter* nonetheless is that Descartes' solution is both conceptually incoherent and empirically flawed as it involves a very speculative set of highly ad-hoc ideas about the function of the pineal gland and the role of the *animal spirits* in facilitating the mediation between two substances that have started firstly by being described as if they were ontologically distinct and separated. Simply put, what has been so drastically detached with one hand can hardly be co-joined in so hasty and unwarranted a manner with the other.

So far I have tackled what may look as an inference to the best argument against the construction of the dualist dichotomy by considering the evidence pointing to a strong correlation between the states of what Descartes calls *res cogitans* and the functioning of the nervous system. Let me now state briefly a second and more decisive reason for rejecting the thesis of substance dualism with the amendment of mind-body interactionism. As a number of materialist philosophers have pointed out, the thought of a non-physical mind that interacts with the physical world contradicts the basic laws of thermodynamics by conflicting with the principle of energy conservation for it does not seem clear at all where the energy necessary for those interactions would come from To counter this objection, H. Bergson (1920) argues for the alleged undetectability of mental-energy in his *Mind-Energy Lectures and Essays* but it is unclear how such a transparently ad-hoc postulation can in fact count as a genuine solution to the trouble.

This rather insurmountable set of hindrances is probably why some contemporary proponents of the dualistic understanding of the relationship between

the mental and the organismal refuse to identify their position with Descartes' classical form of substance dualism. For example, in their 1977 book *The Self and its Brain* John Eccles (1977) bristle at that label but then go on to endorse a doctrine called *interactionism* that leave unanswered the very same obstacles that Descartes' conception encounters. My point here is not that such more scientifically sophisticated versions of mind body dualism need to coincide with the Cartesian view with regard to all its theoretical intricacies. It is clear that they needn't do so, but that hardly means that they fare any better in the face of the objections presented here.

7.3 The Convoluted Plurality of Monism(s)

So far I have pinpointed a number of reasons for making a case against dualism. In what follows I will take notice of how different versions of monism try to avoid these flaws while unavoidably incurring in others of their own. It is interesting to start up by noticing that even if the versions of monism in philosophy of mind, which will be discussed shortly, differ in a number of significant ways, they all agree in the attempt to simplify the number of entities either by reducing the two Cartesian substances to each other or alternatively by dissolving both of them into a third undifferentiated medium. In this respect there is no doubt that monism in philosophy of mind seems to be on the surface a far more parsimonious doctrine when compared to dualism (but see Sober 2015 for a more nuanced discussion). There is nonetheless a fly on the ointment here: counterintuitive as it may sound in light of its parsimonious appeal, there is more than one form of monism when it comes to the body-mind problem. George Berkeley (2002 [1710]) for example famously advocated a philosophical conception where the corporeal world alongside the plurality of physical realities it consists of is reduced away by reanalyzing the *res extensa* as a phenomenal appearance generated by the *res cogitans*. More recently, philosophers such as Bertrand Russell (1921) and others have defended the view that both the mental and the physical are to be understood as different manifestations of a third substance that remains neutral to any of the ontological properties of the Cartesian substances.

When it comes to Berkeley's monism, it is not a good omen that such form of pan-psychism relies on the postulation of incorporeal thinking subjects and so conflicts irremediably with some of the basic tenets of physiology and neuro-psychology. In contrast, Russell's idea is a good trick. However, I think that neutral monism, far from illuminating the relationship between mind and body, walks away from the problem by postulating a third hypostasis which would by itself be prone to the same type of criticism that Aristotle deployed against the platonic forms (i.e. the argument of the third man). There is little to be gained by such a move.

If psychical or neutral monism wouldn't do, perhaps it might be a good idea to try and find the solution to the problem in the parallel reduction of the psychological to the corporeal. Let us determine the diversity of forms such a reductive claim

may adopt. In his 1949 seminal book *The Concept of the Mind*, Gilbert Ryle attempts to exorcise the long-standing *Ghost (in the Machine)* of Cartesian dualism by endorsing the semantic command that mental terminology be translated into behavioral terms (Ryle 1949). The hope is here that such an interpretation of the semantics of the mental would lead to the dissolution of the categorical mistake of considering the mind as a separate and independent substance. While there is merit to this approach considering the sterility and circularity of very many mind-based explanations of behavior, it is also good to notice that Ryle's logical behaviorism fails to show that the notion of behavior can be understood in the absence of cognitive and phenomenal terminology. Actually, as shown by the long history of psychological behaviorism, no matter how studiously one tries to avoid the usage of introspective methodologies and mind-like explanations of the conduct of humans and other animals, without the ideas of cognition and perception the behavior of organisms is rendered psychologically unexplainable.

Ryle's logical behaviorism tries to deal with the mind by means of explaining it away behaviorally; other philosophers have tried to do the same by addressing the problem from a more neurophysiological angle. H. Feigl (1958), U. T. Place (1960) and J. C. Smart (1959; 1963) for example make the claim that mental processes and states are identical with their correlates in their brain in the same way as the reference of Frege's "morning star" is identical with that of the "evening star" (Frege 1892). Given the perfect correlation existing between mental activity in animals and the existence of underlying neurophysiological processes there seems to be a prima facie compelling simplicity argument in favor of this identity theory (but see Sober 2015 for a qualified discussion of mind-brain identity in terms of probability). However, irrespective of its attractiveness, it is worth considering that against a bulk of evidence to the contrary, the mind brain identity theory relies on the substantial empirical assumption that the same mental states are not multiple realizable on different correlates of the nervous systems of a variety of animals of many taxa. In addition to this functionalist criticism against type-identity, another objection to the identity theory stems from the phenomenally irreducible character of the subjective qualia that accompany consciousness (Kripke 1980; Chalmers 1997; Jackson 1998), this being a point that Thomas Nagel made famously in his seminal paper "What is it like to be a bat?" (Nagel 1974). In this regard, unless an amended version of the theory is presented which can make room for this subjective character of mentation, it is hard to avoid the conclusion that there seems to be trouble here for the identity thesis. It is worth noticing that in a more sophisticated versions of the identity-theory, D. Lewis (1966) have defended a causal account of mental properties with an eye on sustaining the plausibility of identifying experiences with their physical correlates. This causal point, if sound, would lead identity theorists to embrace functionalist ideas or even some of the points that J. Searle defended with his *biological materialism* (Searle 2004).

A more drastic avenue within the arena of monism is the one explored by *eliminative materialism* as put forward by Churchland and Churchland (1997). Here's the idea in a nutshell: *if the mind makes problems, why not declare it inexistent?* After all, it is always possible that the concept of mind and other similar

terms of the parlance of folk-psychology will be sooner or later eliminated from the vocabulary of the sciences as part of the worldview of the layman very much like the beliefs in spectral demons, witches or leprechauns have been long so obliterated. More specifically it is conceivable, or so D. Dennett claims (1991), that consciousness and subjective qualia will end up by revealing themselves the artifact of an user's illusions generated by the brain instead of the content of a show performed in front of the *homunculi* of the *Cartesian theatre* fallacy so deeply ingrained in what Dennett calls *Cartesian materialism*.

Is it doable to get rid of the mind in so quick a manner? Maybe so, but only at the cost of getting it back again somewhere else down the road. Here's my divergence with eliminative materialism: the concept of illusion makes sense merely within the realms of psychology of perception and cognitive psychology and so to affirm that consciousness is an illusion leaves open the question of the subjectivity exposed to the illusion itself. In the same vein it is worth remembering L. Rudder Baker's remark (1987) that pretending to explain away the presence of subjective mental states leads to a self-defeating cognitive suicide that starts off assuming in practice the same thing it then tries to deny. I agree with Dennett's critique that the Cartesian theatre is both empirically flawed given the absence of one particular single neural correlate of consciousness, and logically self-refuting. Granted that posing homunculi to explain consciousness in the brain is either viciously circular or involves an infinite regress, but the same applies to declaring consciousness an illusion.

7.4 Non-Reductive Materialism: Functionalism and Emergence

Dualists and reductive materialists of various sorts disagree over which term of the mind and body dichotomy should receive priority in reducing the other. It is easy to see how while they cannot both be correct at the same time; they can on the other hand be equally flawed. Over the last two decades, American philosopher John Searle (2004) has defended an approach he terms *biological naturalism*. Whatever the merits or demerits of this approach, which involves the very ambiguous claim that all mental phenomena are caused by neuro-physical events, it is worthwhile to recognize that Searle is right to highlight that eliminative materialism and the identity theory go obviously astray in denying the existence of mental states phenomenally irreducible to the nervous system. To see why this is so, it is perhaps helpful to remember the thought experiment once proposed by David Chalmers to counter the thesis of reductive materialism: his famous philosophical zombie (p. zombie). Different from zombies in movies or in voodoo culture, a philosophical zombie is qualitatively identical with an ordinary human being except for her total lack of subjective mental states and qualia. On neuro-psychological grounds, it seems highly problematic to assert, as Chalmers does (Chalmers 1996), that such

kind of zombie is principally conceivable (to see why there is trouble here see Bunge 1980; Dennett 1995; Kirk 1999). But what eliminative materialism seems to entail is that we all live in a world fraught by p.zombies. Indeed: if eliminativists were correct, it would follow that we all, human and non-human animals alike, would be p.zombies in a way. I hope that the reader agrees that this is extremely implausible. Actually, Mario Bunge (1980), in his book *The Mind Body Problem. A psychobiological approach* alerts the reader to the somewhat paradoxical fact that the obvious shortcomings of the most radical forms of reductive materialist monism do contribute, given their implausibility, to fuel the superficial appeal of dualism regardless the philosophical pitfalls and even stronger implausibility the later might present. I think that there is a point to such call for caution.

That is perhaps why the doctrine of functionalism has gained massive popularity since the 1960s. Benefiting from the development of cognitive psychology and computer science, functionalists like Hilary Putnam are concerned to avoid the sin of reductionism without falling into the mistake of postulating a substantial mind independent from the brain. To move between Scylla and Charybdis, the functionalist embraces the fancy thesis of the multiple reliability of the mental states on a diversity of neural states (Putnam 1967; Fodor 1974) and then goes on to conclude that, far from identical to the brain, the mind is actually comparable to the software of an electronic device in relation to its hardware. Putting aside the controversy that the idea of multiple realizability has given rise to (Polger 2009), there is a substantial question to be asked here since it is extremely doubtful if such an interpretation of the relationship between the mind and the body does not constitute a reification of the mind as gruesome as the one that it is designed to avoid. One way to see this is by considering that the analogy fails dramatically in that differently from the software of a computer, which is literally and non-metaphorically downloadable to a plurality of hardware platforms, the phenomenal events in the mental life of animal organisms aren't transferable to other physical media out of the organism in question. It is true that following on the steps of the so called Strong AI, there abound proposals postulating that someday such transfer will be technologically feasible; but those are confronted with extremely powerful objections for reasons made manifestly clear by John Searle's Chinese room thought experiment (Searle 1980). It is perhaps true that both an electronic device and an individual human being may speak Chinese with a comparable degree of syntactic accuracy, but pragmatically and semantically these are two verbal behavior patterns that present obvious differences of kind. In a similar vein, if the idea of multiple realizability were to be applied to these very different scenarios, one would do well to distinguish carefully two senses to the notion of multiple realizability itself.

But maybe we could do without the concept of the multiple realizability altogether. After all, in many areas of research, it has become customary to utilize the idea of *emergence* to illuminate the point that there are holistic properties arising from complex systemic wholes that are not entirely reducible to the mere aggregation of their components. In that respect, what the science of complex systems highlights is that in such a diverse array of arenas like those of theoretical biology (El-Hani and Emmeche 2000), minimal life and cognition (Maturana and

Varela 1980; Bitol 2004), climatology (Snyder et al. 2011), social science (Sawyer 2005) and neuro-science (Benasich and Ribary 2018), *more is different* (Anderson 1972). As it is to be expected given the plentiful range of disciplinary endeavors they apply to, such approaches, while revolving around the shared notions of emergence and complexity, differ in a multitude of aspects. There is something though they all seem to agree over, namely: the idea that the levels of complexity of the universe are multifold and exhibit properties that cannot be individualistically understood in terms of the aggregate of their parts but emerge anew as novelties in manners that depend on the integration of the components of the less complex levels. This insight is formulated in various ways depending on the area of concern of the emergentist consensus (Ginsburg and Jablonka 2019) but is usually conceived of as being most useful when deployed to account for processes that depend critically on the consideration of evolutionary novelties. In this regard, the ideas of emergence and levels of complexity have been used to throw light on the origins of life (Ruiz Mirazo 2016), the evolution of individuality and other major transitions in evolution (Buss 1987; Maynard Smith and Szathmáry 1995, 1996), the evolution of language (MacWhinney 1998) or the evolution of consciousness (Zelazo 1998).

In this respect, Mario Bunge (1979) has offered an ontological understanding of the universe based on the contention that the world, as a system of systems, consists of the integrative composition of a plurality of systems, whether of physical, chemical, biological, or neuro-psychological and social character, each possessing and being defined by different sets of properties. According to this proposal emergent properties are irreducible to other less complex levels and thus need to be studied by specific branches of science. It is the organization of the components of each system that gives rise to the new properties in manners that are not predictable or explained solely by considering the laws of the corresponding micro-system. It is easy to note that the notion of *emergence* is at home in such a framework, and so are the ideas of *continuity and discontinuity* (of the variety of levels of the world) and *integration* (of the different sciences that study the diverse systems of the universe). It is worth noticing that Bunge (1979) deploys his emergentist claim within a view of the universe as a coherent whole that emphasizes the ultimate systemic unity of the world in spite of the plurality of the levels of integration. When applied to the case in point, as Bunge himself does in such books as *Mind and Matter. A Psychobiological Approach* (1980) or more recently *Matter and Mind. A Philosophical Inquiry* (2010), these ideas seem promising. Indeed, if the phenomenal peculiarities of mentation are to be understood in terms of the emergent properties of some processes of the nervous system of an individual in constant interaction with other physiological systems (digestive, endocrine, musculoskeletal and the like) of the body instead of as an independent substance, then, there appears to be a way to avoid the spell of dualism without embracing the implausible tenets of reductive materialism. According to this viewpoint, psychological processes are neither the property of individual neurons acting in isolation nor a Cartesian ghost controlling its shell in a non-physical manner. Rather, they represent the end result of the electro-chemical interactions of a whole system of millions of neurons going hand in hand with other organismal (and therefore biological) and social systems.

Mario Bunge openly recognizes that what the emergentist solution suggests is not a full-fledged scientific theory but a path to be explored in detail by further scientific research in neurology and psychology. Here's in a nutshell what this form of neuro-psychological non reductive monism points out to, however sketchily: when thinking about the alternatives of dualism and reductive materialism, avoiding to fall into one of the horns of the dilemma does not need to imply to embrace the other.

There is clear attractiveness to this way of framing things but instead of claiming victory in too quick a manner I would like to give the reader pause here. Although I don't intend to contest the soundness of other aspects of Mario Bunge's systemic ontology or philosophy of science (for more on that see Ongay 2019a), let us explore one of the sides of this usage of the notion of emergence. Even if H. Spencer, C. Lloyd Morgan or J.M. Baldwin did conceive of emergence as a way to make room for novelty in evolution, the coining of the concept is primarily metaphoric in nature. The most usual understanding of the concept of emergence in day-to-day parlance makes reference to a corporeal body that while resting submerged in a fluid may then *emerge* from it to the surface. It is obvious that this scenario is not directly applicable to the case of the emergence of the mind as it is extremely unclear what the ideas of emergence and submersion would positively mean if they were to be taken literally in such a context and various others where either the starting point or the end result of the purported process are not corporeal in nature. Even though taking notice of this metaphorical character of the concept is not by itself a reason for rejecting the use of the idea of emergence in an explanation of the origins and evolution of the mind, it is still important to consider the following point already noticed by Nagel (2012): if the properties to be explained by appeal to the concept of emergence have to be thought of as being virtually present in the level of complexity immediately inferior, then the emergentist position wouldn't seem to be fundamentally different from all the rest of the varieties of reductive monism (perhaps now with a *preformalist twist*); but if they don't, then such an absolute novelty would remain unexplained except by means of a mechanism not that different from the old theological idea of *creatio ex nihilo* (perhaps now in an evolutionary guise, as in Bergson 1911), which of course would *explain* the obscure by the more obscure. In either case, the conclusion follows that unless interpreted in either of these highly unsatisfactory alternative ways, there is very little real explanatory work that the concept of emergence does. Instead, my line of attack suggests that appealing to the emergence of mentation and other evolutionary novelties in the organization of the world is a particularly abstruse verbal reiteration of a truism: *whatever comes anew comes anew* (Ongay 2019b).

One way to counter this objection would be to say that it involves a false dilemma fallacy. Indeed, different from other versions of the idea of emergence (Bergson is here a good case in point), Bunge's emergentism (Bunge 1967, 2003, 2004, 2010) explicitly rejects *creatio ex nihilo* without embracing preformalism and conceives of emergence as an alternative to both. He does so by admitting that rather than a single and universal mechanism to account for qualitative novelty, emergence constitutes a plurality of different mechanisms in each of the scientific domains from the production of the flow of an electric current from electrons in electrostatics

to the synthesis of molecules out of atoms in chemistry or the extinction of aversive memories due to neural processes taking place in the amygdala and other regions of the limbic system in psychology along with other examples from social sciences and economics (Bunge 2004). If this is so, the conclusion seems difficult to escape that given the peculiarities of these processes such a more nuanced idea of emergence would mean (very) different things in different contexts. Of course I don't deny that the principles of each of the aforementioned realms are explanatorily fruitful when accounting for novelty within these very diverse fields. The problem with such qualification is that it is not at all clear what specifically is to be gained in considering all these extremely disparate scientific principles as examples of a single category. In other words: understood in this way, the notion of emergence becomes heuristically redundant in relation to the real principles acting in physics, chemistry, sociology and economics.

7.5 How to Think About the Mind in the Middle of a Stalemate: Psychology and Evolution

Emergentists often think of emergence as an explanatory mechanism by means of which to account for novelty. I agree with them that the dilemma between *reductionism and dualism (cum creatio ex nihilo)* is a false dichotomy. But I don't see how the notion of emergence constitutes a plausible alternative at least when it comes to the problem of the relationship between mind and body. I have argued in the previous section that when the concept fails to be fleshed out with either reductive or overtly theological assumptions about how novelty pops out, the thesis risks staying empirically empty. I have also argued that even if some philosophers tend to conceive of emergence as encompassing a plurality of different mechanisms, doing so detracts from the heuristic significance of the concept itself. But the existence of psychological processes, subjective qualia and mental life is not an empty truism. In fact, a world without them would hardly resemble our own. Think for example about what would be left of the very precise observable morphology of the astronomical and geophysical world if perceptual organisms, with all their qualia, were suppressed. One doesn't need to be a subjective idealist to notice that such recognizable morphology, which in a very real sense *is in the eyes of the beholder*, would correspondingly vanish immediately. Let us not make mistake in here: this is not to say that the material (i.e. the *physical*) depends on the mental (i.e. the *psychological*). At the very least it is well to take notice that the converse is equally true: there is no doubt that there hardly can exist any mind without a physiologically functioning organismal body.

What I want to propose, taking inspiration from ideas developed by Gustavo Bueno (1972) is that the dichotomy between matter and mind is by itself profoundly defective. Far from constituting a spiritual substance, a more adequate materialist account of the mind would interpret it as being as material as the body itself,

both being irreplaceable components of the world we live in. A world that is, in spite of any systemic interpretation to the contrary, as irremediably plural as it is discontinuous (Bueno 1972, 2013, 2016; Gabriel 2015) in its multiple ontological and epistemic parts. It is true that emergentists like Mario Bunge emphatically recognize the existence of discontinuity while searching for patterns of unity (and *convergence*) in diversity (Bunge 2003) under the assumption that the quest for unity is precisely the goal of scientific knowledge. In this respect it is just fair to say that Bunge explicitly rejects monism when interpreted as the position that affirms that the world consists of the same substance. This said nonetheless, contending that the world constitutes a system suitable to be studied by (the integration) of human knowledge represents another form of monism (*order monism* as opposed to *substance monism*). Whatever the case, the assumption appears to be unwarranted: given the plurality and the disconnections between the diverse parts of the world as we know it, it would simply beg the very question to assume that the universe is a system (of systems) in which the different *levels* are hierarchically organized (Bunge 1977) while the whole corresponds to the integration of scientific knowledge (Bunge 1973, 2003). In fact, when what is known so far is taken at a face value without further provisos *about what we will someday know*, there seems to be nor such organized whole neither a unified science of the whole (Ongay 2019a).

Such a plurality and discontinuity can be shown in the reciprocal irreducibility of the mental and the physical. Defending the phenomenal irreducibility of mental processes to the nervous system against the (both epistemically and ontologically mistaken) rigors of identity theory or eliminative materialism does not require that dualism, with its multiples dead ends, should be embraced. Similarly, recognizing that there cannot be mind in the absence of the organismal body given rise to by the evolutionary process does not entail the correctness of reductive monism. Furthermore, what goes by the misleadingly simple name of *mind* is nothing simple either. Whatever the assumptions of the Cartesian metaphysical tradition, it is just a mistake to conceive of the mind as a simple spiritual substance. A quick review of the existing literature about such phenomena as anterograde and retrograde amnesia due to the deterioration of the hippocampus, split brains and location of function in brain (Sperry 1968; Wolman 2012), Capgras delusions or prosopagnosia owing to damage to the temporal cortex and the limbic system or cortical blind-sight (just to name but a few) easily reveals that the territory of the mental involves abrupt discontinuities, too.

But if the emergentists are wrong to assume that the world is a continuous unity where the different systems, in spite of the diversity they imply, integrate with each other giving rise to an ordered array of levels of complexity perhaps with the brain (or in a more general context: the social systems) on the uppermost end of the spectrum, they are also mistaken in saying that invoking the concept of emergence can do the explanatory work. Previously I have manifested the reasons why the use of the general notion of emergence leads to a stalemate when it comes to account for novelty; now I will briefly put the focus on the more specific notion of neural emergence. To see what is wrong with asserting that the mind comes about as the product of a neural emergence let me start off by examining John Searle's more

modest claim (2004) that mentation is causally produced by the activity of the neural system. If Searle's claim is more modest in comparison to the emergentist thesis is because it does not invoke any particular causal mechanism at work. However, more than a heuristic virtue there is trouble in this formulation of the neural origins of mind. The problem stems from the fact that Searle's wording contains an ambiguity concerning the idea of causation. Causality is often understood as a difference-making process (Lewis 1986). It should be clear that if that is what is at stake here then Searle's contention is trivially right as any severe alteration in the functioning of the brain activity would indeed make a difference in the corresponding psychological processes. Also, if causation is to be interpreted, as statisticians usually do, in terms of an event affecting the likelihood of another, then it is equally undeniable that the eventuality of having a mal-functioning brain may lower the probability of the occurrence of certain cognitive events (think for example of patients with injury in the fusiform gyrus and their altered ability to recognize faces) whereas of course the absence of a brain would confer a zero probability on them. This much is all true since, against the assumptions of pan-psychism and animism, there is no mind without a nervous system; very much like, against the premises of dualism, there is nothing in the mental processes that fails to correspond to the respective events in the neural system of the organism in question. However, when leaving aside this abstract characterization of causality to discuss the concrete mechanisms that give rise to the difference-making process itself, things don't look so simple. In considering what causes what and why we should do well not to let Searle's formulation to mistake us into thinking that the nervous system by itself generates mind activity.

Let me formulate this point by making reference to a metaphor William James famously used to cast light into the nature of consciousness. In the first volume of his *Principles of Psychology* (1890), James describes consciousness as a flowing stream. In doing so, James is following in the steps of David Hume's bundle theory of the impermanent self and paving the way for much of the best nineteenth and twentieth centuries literature, from Henry James to James Joyce. What I want to emphasize in this context is that there is no way to make a sense out of such a stream of consciousness except in relation to a biological and evolutionary scenario that requires the body of an animal organism in its interactions to other individuals. Much like in biology, *nothing in psychology makes sense except in the light of evolution*. If this roughly *Dobzhanskyan* interpretation is correct, then it is also worth noticing that evolution does not demand a reified brain (*in or out a vat*) acting in isolation, as that would tantamount the biologically absurd hypostasis of an organ. Instead of organs, evolution works on populations of organisms interacting with other organisms within an ethological and ecological context out of which the brain would hardly retain any evolutionary meaning at all. It is only in this context that sense perception, cognition, and consciousness can possibly exist, but not as the effect of the nervous system, but as a set of processes and operations that depend on the presence of the multiple components of the niche the organism occupies. Studies in developmental and phenotypic plasticity (West-Eberhard 2003) neuroplasticity (Ganguly and Poo 2013), niche construction and ecological inheritance

(Laland 2017; Odling-Smee et al. 2003) and animal traditions (Avital and Jablonka 2000) help cement the extremely important point that experience and behavior are factors that alter the brain every bit as much as they are caused by it. In the midst of such a thick web of feedback loops as well as such a density of causal arrows it is well to conclude against some of the less nuanced contentions of people such as F. Crick (1994), A. Damasio (1999, 2010) and a number of others (Dehaene 2014) that, as Markus Gabriel (2017) cogently argues, the brain cannot provide all the answers in the causal origination of mentation and consciousness. This is not because it is not *necessary* but rather because the brain hardly *suffices* to account for the behavior of an organism in its multiply biological, social and cultural dimensions (Gabriel 2017; Jablonka and Lamb 2005; Pérez Jara 2014)

But how does the mental come about? This question remains a valid one at least so long as the eliminativists and epiphenomenist are wrong to assume that we can do without the mind altogether. I have contended that the line of reasoning of the emergentists is epistemically idle, but that is not to deny that the evolution of organisms with mentation represents a genuine problem. The late Thomas Nagel (2012) for example pointedly disputes the assumption that the puzzle is solvable within the realm of naturalistic science whereas in a more naturalistic fashion Chalmers (1996) holds the view that the mind represents an originally fundamental level of the universe. Although I do interpret these positions as responses to the flaws of reductive physicalism, of course rejecting monism does not license substantifying the mind or declaring it inexplicable. Instead of that, what I will propose in the next section is to change the metaphor: from the concept of *emergence* to that of *anamorphosis*.

7.6 Matter, Mind and Anamorphosis

In one of its most common usages in English the Greek term *anamorphosis* refers to the visual representation of a type of distorted graphical projection in which the viewer needs to adopt a precise vantage point to perceive a recognizable visual shape that would otherwise go unnoticed. In this artistic use of the geometrical properties of affine transformations frequently employed to hide the representation of obscene scenes, the contemplator, due to the focal position she adopts, manages to get back (*anas*) a form (*morphe*) that had been previously deconstructed by the distortion. Thus far the concept so described is obviously optical and geometrical in character, however, and rather appropriately *there is more than meets the eye here*: Spanish philosopher Gustavo Bueno (1993) uses the term to allude metaphorically to an alternative explanatory strategy of evolutionary or metamorphic processes. Different from reduction or emergence, anamorphosis involves the unraveling of the plurality of components of which a given *explanandum* consists and its subsequent reconstruction in combination with other aspects of the surrounding environment to deliver back the *explanandum* in question. By means of example let us think of the structure of a modern human political society in relation to the social dynamics

of a group of great apes. There is no doubt that the zoological and ethological regularities that social biology brings to the fore, act in both cases. But it is equally true that, much against the best efforts of human ethology, sociobiology and evolutionary psychology, attempting to reduce the specific functioning of a human political system to such socio-zoological dynamics would imply to obscure the most specific characteristics of human culture (from legislation to the peculiarities of capitalist economy, from the history of baroque painting to the development of the natural sciences or the intricacies of catholic theology) in so long as they cannot be plentifully and in detail reconstructed by zoology. It would be in vain to say that the advent of those aspects is the end result of an emergence bringing about new holistic properties from the interaction between some parts (the zoological individuals) that already possessed such emergent properties potentially. A group of pre-hominids does not present the characteristics of such areas of human culture either in actuality or in potentiality. Much more appropriate to the case in point would be to say that it is modern human societies themselves that exhibit all the aspects and regularities of primate social biology but only do so in combination with other patterns made possible by the development of material culture to an extreme unparalleled in the biological realm (Boyd and Richerson 2005). In this regard, the idea of anamorphosis as utilized by Gustavo Bueno implies that the most characteristic features of civilized human culture do not emerge from animal social traditions or are reducible to them but rather can be reconstructed as the combination of the basic principles of social biology as well as the drives spoken of in the territory of ethology and psychobiology alongside other processes that find no real parallel in any other animal taxa. In this regard, rather than treating these features of human social and cultural life as a transition in evolution (Maynard Smith and Szathmáry 1995) with a corresponding increase in complexity (and the difficulty of finding a non-tautological criteria to measure complexity), Gustavo Bueno's usage of the idea of *anamorphosis* invites us to recognize the limits of the scope of what evolutionary biology can tell us (Dupré 2003) and constitutes a mark of the incommensurability between both the different scientific domains and the ontological categories the world is divided in.

Let see how this applies to the relationship between the mind and the brain. Having rejected the position of dualism due to the anti-scientific assumptions it endorses, it may sound natural to try and explain the mind by reducing it away in terms of the activity of the neuro-physiological system. In fact this wouldn't do. While it is easy to refer action, emotion, cognition and perception to the functioning of the neurons, the task of re-obtaining these subjective phenomena back again encounters a number of formidable difficulties, being the binding problem and the neurological origins of consciousness perhaps two of the most pressing of such obstacles. If so, reduction does not seem to be a promising alternative in the treatment of the mental. For reasons that I have already expressed however, emergence does not score much better. Now, the fact that emergence and reduction cut no ice does not mean that the mind is inexplicable. Against all the odds of the proponents of the epistemic gap, I agree with Ginsburg and Jablonka (2019) that mental life, so overwhelmingly present to different taxa from arthropods (Barron

and Klein 2016) to mollusks (Godfrey-Smith 2016) to vertebrates (Griffin 1992) originates in the context of a biological scenario where the eventuality of having an anatomically and physiologically complex nervous system is to be sure a completely necessary component.

The brain nonetheless is not enough by itself since cognition for example, and myriads of other psychological processes (think of perception, attention or emotions) are not a product of the frontal lobe of the cerebral cortex. Apart from the unimpaired neural activity of the forebrain, cognition requires the presence of external stimulation coming from the environment of the organism as well as the cooperation of other distal sense organs, and multitudinous physiological process (from digestion and excretion to blood circulation or breathing) not to mention the social and cultural matrix the individual is a part of. Much the same applies to other psychological functions, too: out of this intertwined set of factors, mental processes would be rendered unconceivable. Visual perception for instance is far from being reducible to (or presented as an effect of) the visual cortex of the occipital lobe though it by no means could occur if such cerebral area were severely impaired. Perception is not the result of an emergence from the brain either. In fact it requires parts of the brain acting in the context of the activity of very many other body organs and tissues and a set of behavioral operations of the organism within its ecological and social niche. Without such a niche there would be hardly anything to be perceived.

This is why a brain in a vat (Putnam 1981) even with the quantum behavior of the microtubules (Hameroff and Penrose 2011) would never produce a mental life of its own much as a Cartesian *res cogitans* would never function intellectually in the absence of an organic body. Conversely, I hope that the reader notices that this is a story that can be read backwards: an animal organism with a cortex couldn't possibly fail to bring about a set of psychological states so long as it is situated within a proper ecological and social niche. As Kripke (1980) notices rightly this is why there is something seriously mistaken to Chalmers' claim that p-zombies, even if biologically impossible, are logically conceivable. I think that precisely *what makes them* inconceivable is their biological impossibility. There is an undeniable structural, though not necessarily causal, relationship between the neurobiological and the mental but beyond that there is also probably not much else to date to say about the origination of the mental *from* the physical.

There is a further twine to the question. So far I have talked about what could be called the ontogeny of mental life. In what follows I will change the subject a little bit to tackle the problem of the evolution of consciousness. In parallel to work developed on the origins of the universe (Kraus 2012) or living systems (Orgel 1998; Schrödinger 2012), many theoretical proposals have been put forward in relation to the origins of consciousness and mental life. To refer to a recent example, Ginsburg and Jablonka (2019) take notice of what they call unlimited associative learning (UAL) as an evolutionary transition marker for consciousness and then describe how the evolutionary acquisition of UAL in three different taxa (*Mollusca*, *Anthropoda* and *Vertebrata*) may have been one of the drivers of the Cambrian explosion. Ginsburg and Jablonka's approach has the virtue of framing the question by placing

it in the general framework of the major transitions in evolution. Within this general theoretical context what Ginsburg and Jablonka do is to add a further transition that Maynard Smith and Szathmáry had failed to contemplate in their classic treatment of the issue (Maynard Smith and Szathmáry 1995, 1996). Comparably, Daniel Dennett (2017) offers an account of the evolution of mind that tries to reconstruct its phylogeny by relying on the concept of meme as a bridge between the simplest living organisms and the most sophisticated products of the human mind (*From Bacteria to Bach*). There is little doubt that these accounts are insightful and plausible. My goal here is not to judge their plausibility however, but rather to indicate one important methodological feature they present. Richard Dawkins' popular book *The Ancestor's Tale* (2004) helps to illustrate such feature. It is very significant to see how Dawkins' reconstruction of the general *tale* of evolution starts backwards: my point here is that putting aside the literary significance of this way of telling the story, there is a substantial reason why it does so. In fact, in trying to provide an account of the origin of the universe, life on earth or consciousness, it is hardly possible to do otherwise as no matter how absolute a starting point one decides to begin with, the process of reconstruction will invariably presuppose the very end result that it is meant to bring about.

To make this point let me refer to a scenario in the history of German idealism. In his famous critique to Schelling's philosophy of nature, Wilhelm Traugott Krug emphatically asserted the impossibility of deducing his own pen, something to which Hegel responded contemptuously that the *absolute* should not be expected to deduce the contingent products of nature. Taking inspiration from Krug's claim, I think there is a revealing analogy to be drawn in this context: deducing the physical universe, the origins of life or the evolutionary flourishing of mental life from a quantum vacuum, an aperiodic crystal or the Ediacaran biota, respectively where there were of course neither physical particles, living organisms or mental life, may represent a fiercely daunting challenge—indeed an undoable one—unless the result of the deduction is taken from granted from its very beginning. To attest the extent to which this is so consider for example the concept of pre-biotic chemistry of so wide circulation in the context of current research on *abiogenesis* (Orgel 1998) and how its very framing implicitly involves the very notion of life that it is supposed to give an explanatory account of. Perhaps the most natural way of thinking about the issue at hand would be to recognize openly that the elucidation of the origin of the physical universe, life and mentation are problems that escape the limits of physics, biology and psychology respectively.

If this sounds as a vicious circle or a *diallel* (the argument of the Wheel) as Agrippa or Sextus Empiricus among other salient figures in the history of classical skepticism would have had it, the reader should always do well to grant that it is one of a very distinctive sort: the type of a diallel that trying to delve into the absolute origins of the world (or life or consciousness) inevitably entails. In that respect and as Bruno Latour and Shirley C. Strum remark in relation to the origin of human society, we are always unavoidably very far away from the beginning (Latour and Strum 1986).

I hope that the reader does not conclude from the last paragraph that I am “against materialism”. It would be equally mistaken to interpret it as a call to unrestricted skepticism. The conclusion I want to extract from this picture sounds very differently. Recognizing with a pinch of skepticism that any reconstruction of the origin of mentation will unavoidably be circular in character does not indulge one to endorse a mystical representation of the mind as a spiritual substance that escapes the best of our scientific and philosophical understanding of the world. What neuro-psychology and other areas of scientific endeavor in biology show is more than enough to refute categorically the theological idea of a mind without a body (whether of human, angelic or divine nature). As Gustavo Bueno proposes pointedly (1999) such a rebuttal of the existence of incorporeal living entities represents precisely what materialism is all about in ontology. But this is not to deny that there are aspects and processes in our entirely material world that will always remain above and beyond our categorizing keen, far exceeding the fragments of reality we are in control of. The concept of anamorphosis is precisely at use when it comes to critically limit the pretensions of any purported explanation of what there is to date no explanation for. In all those cases the content of *docta ignorantia* may well be all that there is to know.

It is worthwhile to recognize that even if as everybody in the realm of neurology and neuroscience admits there is no current explanation of the ontogenetic and phylogenetic origins of mentation, such an epistemic feature of the current state of neurobiology says nothing whatsoever by itself about what the future developments of the problem will be like. Maybe the future of the disciplines involved will deliver a solution of how consciousness originates. If so my call for critical skepticism will unavoidably be seen as overly pessimistic. Perhaps so, but the point remains that taking into account the present state of the art it would rather be an argument from ignorance to assume *today* that such solution will be ever found.

To keep things simple I have hitherto made reference solely to what we cannot know about the origins of the mind. Let me finish now with a note on the implications of what has been said so far for the ontology of the world. In his famous address *Über die Grenzen des Naturerkennens* to the Prussian Academy of Sciences, German physiologist Emil du Bois-Reymond stated that there are not just some things that we don't know but also some others that we will never know. It would be a mistake to confuse this appeal to *docta ignorantia* with a wholesale negation of knowledge, after all it is easy to see that knowing about the limits to what there is to be known is a very precise form of knowledge. The negative fabric of this epistemic thesis shouldn't be a reason for neglecting its rather consequential and fully materialist ontological ramification, one that I can only suggest here: far from being made in God or human-likeness, *the world is not a self-contained and all-intelligible unity awaiting to be mirrored by our scientific efforts since it may well be rather an infinite plurality that far escapes whatever homogeneous and all-encompassing treatment we keep hoping for.*

7.7 Concluding Remarks

Risking some repetition I will isolate in what follows some of the most relevant upshots of the analysis with the aim of guiding the reader to what I take to be the real *take-home messages* of the chapter.

1. While the dualist and pan-psychist solutions to the mind–body problem are fraught by insurmountable difficulties having to do with the many incompatibilities of these doctrines with the present state of biological and neuro-physiological sciences, the various reductive accounts of the mind, confronted with multitudinous problems of their own, don't seem to fare too well either. In these conditions it is just fair to conclude that these positions all represent *cul-de-sacs* albeit for different reasons.
2. Owing to the insufficiencies of physicalism and dualism alike, some philosophers have presented more sophisticated alternatives to the problem. In this paper I have addressed the thesis of functionalism and emergence to say that (a) the notion of multiple-realizability is problematic as it heavily relies on an analogy between biological organisms and IA devices, which simply seems not to obtain, and (b) the thesis of emergence is ambiguous and admits different interpretations. While according to some of its versions the idea of emergence involves a mechanism dangerously close to the theological premise of a *creatio ex nihilo*, other views of it are not really different from reduction. Most prominently, Mario Bunge presents a more nuanced and promising conception of the emergentist thesis, however I have offered reasons for thinking that such version of the notion is heuristically inert.
3. As an alternative to dualism, physicalism and emergence, Gustavo Bueno argues for a methodology he terms *anamorphosis*. This conception of the relationship between mind and body emphasizes that mentation depends critically of a physiologically functioning organismal body but also highlights the import of the eco-biological environment surrounding the organism.
4. Whatever the case there is currently no explanation of how and why the mind originates and there is also no principled reason to expect that this account will be accomplished in the future. This shouldn't be understood as an argument for unrestricted skepticism or as a plea for epistemic pessimism but certainly it would be a mistake not to take this particular piece of ignorance (and many others) at a face value. After all, it is well to remember against all forms of ontological and epistemic monism that the world contains processes that are unknown and will perhaps always remain so.

References

- Anderson, P.W. 1972. More is different. *Science* 117(4047):393–396.
- Auyeung, B. et al. 2009. Fetal testosterone and autistic traits. *British Journal of Psychology* 100:1–22
- Avital, E. and E. Jablonka. 2000. *Animal Traditions. Behavioral Inheritance in Evolution*. Cambridge: Cambridge UP.
- Baker, L.R. 1987. *Saving Belief. A Critique of Physicalism*. Princeton: Princeton UP.
- Barron, A.B. and C. Klein. 2016. What insects can tell us about the origins of consciousness. *PNAS* 113(18):4900–4908.
- Benasich, A.A. and Ribary, U. (eds). 2018. *Emergent Brain Dynamics. Pre-birth to Adolescence*. Cambridge MA: MIT Press.
- Bergson, H. 1911. *Creative Evolution*. London: George Allen and Unwin.
- Bergson, H. 1920. *Mind-Energy. Lectures and Essays*. New York: Henry Holt and Co.
- Berkeley, G. 2002. *A Treatise Concerning the Principles of Human Knowledge*. Mineola: New York: Dover Publications.
- Bitol, M. and P. Luisi. 2004. Autopoiesis with or without cognition. Defining life at its edge. *Journal of the Royal Society Interface* 1(1):99–107.
- Boyd R. and P.J. Richerson. 2005. *Not by Genes Alone. How Culture Transformed Human Evolution*. Chicago: University of Chicago Press.
- Bueno, G. 1972. *Ensayos Materialistas*. Madrid: Taurus.
- Bueno, G. 1993. *Teoría del Cierre Categorial. Vol 5*. Oviedo:Pentalfa.
- Bueno, G. 1999. Los límites de la Evolución en el Ámbito de la Scala Naturae. In *Evolucionismo y Racionalismo*, eds. Molina, E., Carreras, A., and Puertas, J. Institución Fernando el Católico (CSIC)- Universidad de Zaragoza.
- Bueno, G. 2013. *Sciences as Categorial Closures*. Oviedo: Pentalfa.
- Bueno, G. 2016. *El Ego Trascendental*. Oviedo: Pentalfa.
- Bunge, M. 1967. *Scientific Research I. The Search for System*. Berlin-Heidelberg: Springer-Verlag.
- Bunge, M. (ed.) 1973. *The Methodological Unity of Science*. Dordrecht-Boston: D. Reidel Publishing Company
- Bunge, M. 1977. *Treatise on basic philosophy. Vol 3. Ontology I: The Furniture of the World*. Dordrecht-Boston: D. Reidel Publishing Company.
- Bunge, M. 1979. *Treatise on Basic Philosophy. Vol 4. Ontology II: A World of Systems*. Dordrecht-Boston: D. Reidel Publishing Company.
- Bunge, M. 1980. *The Mind-Body Problem. A Psychobiological Approach*. Oxford: Pergamon Press.
- Bunge, M. 2003. *Emergence and Convergence: Qualitative Novelty and the Unity of Knowledge*. Toronto: University of Toronto Press.
- Bunge, M. 2004. *How does it work. The search for explanatory mechanisms*. *Philosophy of the Social Sciences* 34(2):182.
- Bunge, M. 2010. *Matter and Mind. A Philosophical Inquiry*. Dordrecht: Springer.
- Buss, L. 1987. *The Evolution of Individuality*. Princeton: Princeton UP.
- Campbell, R. and M.A. Conway. (Eds). 1996. *Broken Memories: Case Studies in Memory Impairment*. Malden: Blackwell Publishing.
- Chalmers, D. 1996. *The Conscious Mind. In Search of a Fundamental Theory*. Oxford: Oxford UP.
- Chalmers, D. 1997. Moving Forward on the Problem of Consciousness. *Journal of Consciousness Studies* 4(1):3–46.
- Churchland, P.M. 1980. In defense of naturalism. *Behavioral and Brain Sciences* 3(1):74–75.
- Churchland, P.M and P.S. Churchland. 1997. *On the Contrary*. Cambridge MA: MIT Press.
- Crick, F. 1994. *The Astonishing Hypothesis. The Scientific Search for the Soul*. New York: Touchstone.
- Damasio, A. 1999. How the brain creates the mind. *Scientific American* 281(6):112–117.

- Damasio, A. 2010. *Self Comes to Mind: Constructing the Conscious Brain*. New York: Pantheon Books.
- Dawkins, R. 2004. *The Ancestor's Tale. A Pilgrimage to the Dawn of Life*. London: Weidenfeld and Nicolson.
- Dehaene, S. 2014. *Consciousness and the Brain: Deciphering how the Brain Codes our Thoughts*. New York: Penguin Books.
- Descartes, R. 2017a. *Meditations on First Philosophy*. Cambridge: Cambridge UP.
- Descartes, R. 2017b. *The Passions of the Soul*. Indianapolis-Cambridge: Hackett Publishing Co.
- Dennett, D.C. 1991. *Consciousness Explained*. New York: Little, Brown and Co.
- Dennett, D.C. 1995. The unimagined preposterousness of zombies. *Journal of Consciousness Studies* 2:322–326.
- Dennett, D.C. 2017. *From Bacteria to Bach and Back. The Evolution of Minds*. New York-London: W.W. Norton and Co.
- Dupré, J. 2003. What the theory of evolution can't tell us. *Critical Quarterly* 42(3):18–34.
- Eccles, J. and K.R. Popper. 1977. *The Self and Its Brain*. New York: Springer.
- El-Hani, Ch. and C. Emmeche. 2000. On some theoretical grounds for an organism-centered biology: property emergence, superveniene and downward causation. *Theory in Biosciences* 119(3):234–275.
- Feigl, H. 1958. The “Mental” and the “Physical”. In *Concepts, Theories and the Mind-Body Problem*, eds. Feigl H. Scriven. M., and Maxwell, G. Minneapolis: University of Minnesota Press.
- Feldman, R. et al. 2007. Evidence for a neuro-endocrinological foundation of human affiliation plasma oxytocin levels across pregnancy and the postpartum period predict mother–infant bonding. *Psychological Science* 18(11):965–970.
- Fodor, J. 1974. Special sciences or the disunity of science as a working hypothesis. *Synthese* 28:97–115.
- Frege, G. 1892. Über Sinn und Bedeutung. *Zeitschrift für Philosophie und philosophische Kritik* 100(1):25–50.
- Gabriel, M. 2015. *Why the World Does not Exist*. Cambridge: Polity Press.
- Gabriel, M. 2017. *I Am Not a Brain*. Cambridge: Polity Press.
- Ganguly, K. and M.M. Poo. 2013. Activity-dependent neural plasticity from bench to bedside. *Neuron* 80(3):729–741.
- Ginsburg, S. and E. Jablonka. 2019. *The Evolution of the Sensitive Soul. Learning and the Origins of Consciousness*. Cambridge MA: MIT Press.
- Griffin, D. 1992. *Animal Minds*. Chicago and London: Chicago UP.
- Godfrey-Smith, P. 2016. *Other Minds. The Octopus, the Sea and the Deep Origins of Consciousness*. Farrar, Straus and Giroux.
- Hameroff, S.R. and R. Penrose. 2011. Consciousness in the Universe. Neuroscience, quantum space-time geometry and Orch OR theory. *Journal of Cosmology* 14.
- Jablonka, E. and M.J. Lamb. 2005. *Evolution in Four Dimensions. Genetic, Epigenetic, Behavioral and Symbolic Variations in the History of Life*. Cambridge MA: MIT Press.
- Jackson, F. 1998. *Mind, Method and Conditionals*. London: Routledge.
- James, W. 1890. *Principles of Psychology*. New York: Henry Holt and Co.
- Kirk, R. 1999. Why there couldn't be zombies. *Proceedings of the Aristotelian Society (Supplementary Volume)* 73:1–16.
- Kraus, L. 2012. *A Universe from Nothing*. New York: Free Press.
- Kripke, S. 1980. *Naming and Necessity*. Cambridge: Harvard UP.
- Laland, K. 2017. *Darwin's Unfinished Symphony. How Culture Made the Human Mind*. Princeton: Princeton UP.
- Latour, B. and S.C. Strum. 1986. Human social origins: Oh, please, tell us another story. *Journal of Social and Biological Structures* 9(2):169–187.
- Leibniz, G.W. 1965. *Monadology and Other Philosophical Essays*. Indianapolis: Bobs and Merrill Co.

- Levine, J. 1983. Materialism and qualia. The explanatory gap. *Pacific Philosophical Quarterly* 64:354–361.
- Lewis, D. 1966. An argument for identity theory. *Journal of Philosophy* 63:17–25.
- Lewis, D. 1986. Causation in. *Philosophical Papers, vol II*. Oxford: Oxford UP.
- MacWhinney, B. 1998. The emergence of language. *Annual Review of Psychology* 49(1):199–227.
- Malebranche, N. 1980. *Dialogues on Methaphysics*. New York: Abaris Books.
- Maturana, H.R and F.J. Varela. 1980. *Autopoiesis and Cognition. The Realization of the Living*. Dordrecht: Reidel Publishing Co.
- Maynard Smith, J. and E. Szathmáry. 1995. *The Major Transitions in Evolution*. Cambridge MA: MIT Press.
- Maynard Smith, J. and E. Szathmáry. 1996. The major transitions in evolution. *Journal of the History of Biology* 29(1):151–152.
- Morhenn, V. et al. 2012. Massage increases oxytocin and reduces adrenocorticotropin hormone in humans. *Alternative Therapies* 18(6):11–18.
- Nagel, Th. 1974. What is it like to be a bat? *The Philosophical Review* 83(4):435–450.
- Nagel, Th. 2012. *Mind and Cosmos. Why the Materialist neo-Darwinian Conception of Nature is Almost Certainly False*. Oxford: Oxford UP.
- Odling-Smee, F., K. Laland, and M.W. Feldman. 2003. *Niche Construction. The Neglected Process in Evolution*. Princeton: Princeton UP.
- Ongay, I. 2019a. Is simplicity a myth? Mach and Bunge on the principle of parsimony. In *Mario Bunge: A Centenary Festschrift*, ed. Matthews, M. Dordrecht: Springer.
- Ongay, I. 2019b. Mente y materia: una revisión de la filosofía de la mente de Mario Bunge. In *Homenaje a Mario Bunge. El último ilustrado*, ed. Marino, A. Buenos Aires: Eudeba.
- Orgel, L.E. 1998. The origin of life—a review of facts and speculations. *Trends in Biochemical Sciences* 23(12):491–495.
- Parkin, A.J. 1996. *Explorations in Cognitive Neuropsychology*. Sussex: Psychology Press Ltd.
- Pedersen C.A. and M.L. Boccia. 2003. Oxytocin antagonism alters rats dams' oral grooming and upright posturing over pups. *Physiology and Behavior* 80(2–3):233–241.
- Pérez Jara, J. 2014. *La Filosofía de Bertrand Russell*. Oviedo: Pentalfa.
- Place, U.T. 1960. Materialism as a scientific hypothesis. *Philosophical Review* 69:101–104.
- Polger, Th. 2009. Evaluating the evidence for multiple realization. *Synthese* 167:457–472.
- Putnam, H. 1967. Psychological predicates. In *Art, Mind and Religion*, eds. W.H. Capitan and D.D. Merrill. Pittsburgh: Pittsburgh UP.
- Putnam, H. 1981. *Reason, Truth and History*. Harvard MA: Cambridge UP.
- Quine, W.V. 1961. *From a Logical Point of View*. Harvard MA: Cambridge UP.
- Rosenzweig, M.R. et al. 1962. Effects of environmental complexity and training on brain chemistry and anatomy: A replication and extension. *Journal of Comparative Physiological Psychology* 55:429–437.
- Ruiz Mirazo, K. and A. Moreno. 2016. Reflections on the origin of life. More than an evolutionary problem. *Metóde. Science Studies Journal* 6:151–159.
- Russell, B. 1921. *The Analysis of Mind*. London: George Allen and Unwin.
- Ryle, G. 1949. *The Concept of Mind*. Chicago: Chicago UP.
- Sawyer, K. 2005. Social emergence. *Societies as Complex Systems*. Cambridge: Cambridge UP.
- Schrödinger, E. 2012. *What Is Life?* Cambridge: Cambridge UP.
- Searle, J. 1980. Mind, brains and programs. *The Behavioral and Brain Sciences* 3:417–457.
- Searle, J. 2004. *Mind. A Brief Introduction*. Oxford: Oxford UP.
- Smart, J.J.C. 1959. Sensations and brain processes. *Philosophical Review* 68:141–156.
- Smart, J.J.C. 1963. Materialism. *Journal of Philosophy* 60:651–662.
- Snyder, C.W., M.D. Mastrandea, and S.H. Schneider. 2011. The complex dynamics of the climate system: constraints on our knowledge, policy implications and the necessity of systems thinking. In *The Philosophy of Complex Systems*, ed. Hooker, C., 467–505. Oxford–Amsterdam: Elsevier.
- Stephen, I.D., M.K. Mahmut, T.I. Case, J. Fitness, R.J. Stevenson. 2014. The uniquely predictive power of evolutionary approaches to mind and behavior. *Frontiers in Psychology* 5:1372.

- Striedter, G.F., J.C. Avise, and F.J. Ayala. 2012. In the light of evolution VI: Brain and Behavior. *PNAS* 109(supplement 1):10607–10611.
- Sober, E. 2015. *Ockham's Razors. A User's Manual*. Cambridge: Cambridge UP.
- Sperry, R.W. 1968. Hemisphere disconnection and unity in conscious awareness. *American Psychologist* 23:723–733.
- West-Eberhard, M.J. 2003. *Developmental Plasticity and Evolution*. Oxford: Oxford UP.
- Wollett, K. and E.A. Maguire. 2011. Acquiring “the Knowledge” of London’s layout drivers structural brain changes. *Current Biology* 21(24):2109–21014.
- Wolman, D. 2012. The split brain: a tale of two halves. *Nature* 483:260–263.
- Zelazo, P. and P.R. Zelazo. 1998. The emerge of consciousness. *Advances in Neurology* 77:149–163.

Chapter 8

Materialism and the History of Science



Lino Camprubí

Abstract While the links between history of science and materialist epistemology are widely discussed (and divergently interpreted), this chapter explores the relationships between history of science and ontology. Its main goal is to vindicate the coordination between constructivism and (critical) realism as one of the main open problems in current ontology. My proposal is thus a contribution to the current conversation in History and Philosophy of Science (HPS), which I roughly review in the introduction. The first section attempts to gauge the philosophical import of the growing presence of “matter”, “materialism”, and “ontology” in history of science and related disciplines. Section 8.2 argues that, in order to enhance their philosophical productivity, discussions on matter and materiality ought to be accompanied by ontological discussion. Following Gustavo Bueno’s discontinuous (non-reductive) materialism, I suggest that sciences result from bodily operations with chunks of the world which are pre-organized according to both ontological and historical scales. These operations include semantic and syntactic transformations that imply different degrees of continuity between objects and signs. What is specific to the sciences is that necessary relationships can emerge between signs in propositional theories which imply unforeseen relationships between objects. One of the main open problems in philosophy of science is to account for this objective necessity given science’s historically contextual and operational dimension. Although in a rather schematic form, I put this categories to work in an analysis of physical oceanography (this analysis also reveals ways in which the history of a science is relevant to science’s current structure). In the last section, I explain how the proposed operational notion of truth serves to reconstruct the distinction between natural and human sciences, but I also show the complexity and nuances of that distinction. Again through the example of oceanography, I show that the earth and environmental sciences have turned towards history in search for anthropogenic change.

L. Camprubí (✉)

Departamento de Lógica y Filosofía de la Ciencia, University of Seville, Sevilla, Spain
e-mail: lcamprubi@us.es

8.1 Introduction: The Ontology of *History and Philosophy of Science* (HPS)

The discussion about intersections between history of science and philosophy of science is a time-honored one which has taken multiple forms (Arabatzis and Schikore 2012). Norwood Russell Hanson, founder of the first HPS Department (at Indiana), famously argued that history needs philosophy to guide its research and that philosophy needs history to gather content for its own reflections (Hanson 1962). From then onwards, many arguments have come to refute this assertion or to move it further. Since this question interests me here only to introduce this chapter's main goal, let me briefly present some of the existing approaches as grouped into four possible sets of relationships:

1. $HS + PS = 0$. For a number of schools of thought, there are either none or very few relevant intersections between history of science and philosophy of science. From the part of philosophers, logical positivism and many strands of analytical philosophy of science have held that history can at its best reveal the inner-workings of the genesis of science (contexts of discovery) but say very little about structure and meaning (contexts of justification). But Hans Reichenbach's distinction between discovery and justification has been rightly called into question. This is so, among other reasons, because there is no discovery without justification, that is, questions of truth and logic (and thus structural relationships with established knowledge) are present from the onset in any discovery worth the name (Arabatzis 2006). Other authors, however, have restated the separation between HS and PS on different grounds. Ronald Giere for instance, argued at first (1973) that philosophy is normative and history is descriptive. Then, after turning to naturalist approaches of science in practice, he held that philosophy of science could still gain more from sociology and psychology than from history (Giere 2011).

From the historians' side, the divorce is more usually certified than argued for, particularly in the later years of the past century, dominated by local histories. Most historians would accept that some philosophical problems are hardly escapable or at least worth entertaining. But they also held, and I believe we can accept this as a non-problematic compromise, that not *all* problems of philosophy of science need to benefit from historical approaches and that not *all* historical approaches need to be equally philosophically informed. To understand in which forms the relationship can be most productive, however, it is useful to look at the other three sets of approaches.

2. $HS < PS$. Several philosophers of science have argued that the history of science cannot move forward without at least some basic philosophy of science. Among other functions, philosophy contributes to questions so central to the history of science as what is science and what is not (Popper 1959[1935]) or, no less ambitiously, how to distinguish the natural and the human sciences (Hacking 1996). The usual answer by the historian is that actors' themselves make that

decision. And yet, writing history of science from purely actors' categories is likely as impossible as it is futile. At least, present scientific notions are often called for to make sense of past scientific practices (Alvargonzalez 2013; Arabatzis 2019).

Most philosophies of science, moreover, could be read as implicit or explicit heuristic programs for historians, and at times the systems of Imre Lakatos or Karl Popper have been interpreted as such (Laudan 1989). From this perspective, historians' role would be to confirm the philosophical theories, hopefully without need of forcing the historical materials. More generally, philosophers and historians inclined towards grand theories and worldviews would tend to explicate history of science as the succession of big philosophical ideas (Gillispie 1960). One does not need to admit these or any other strong position on this matter to note that histories of science, no matter how local and empirical, mobilize philosophical terminology of one sort of the other, including, importantly for this chapter, "matter".

3. *HS > PS*. Historicists of different varieties have argued that philosophy of science is best understood historically, be it through the history of philosophy of science in relationship to the sciences (Friedman 1993; Hatfield 1996; Sturm 2014) or directly as a reduction of the main epistemological issues to history (McMullin 1976; Shapere 1977; Rheinberger 2010a). Late Edmund Husserl (1962[1936]) spoke of "historical *a priori*" to vindicate the role of historically-emergent ideas and practices in establishing the conditions of possibility for new knowledge production. Against historicism, of course, he thought of this *a priori* as necessary: the temporal unfolding of the constituting transcendental ego, but others took this essence to be processual, subject to change. For authors like Gaston Bachelard, writing also in the interwar period, history and not philosophy would be charged with discerning the *a priora* (Rheinberger 2010b). Bachelard's successor as director of the Institute d'Histoire de Sciences, Georges Canguilhem (1966[1983]), considered history of science among the main goals of epistemology: because scientific objects are not given by nature but historically shaped, they could only be accounted for historically.

Similarly, hard interpretations of Kuhnian ideas about incommensurability leave little room for philosophical discussion beyond persuasion, which is socially (historically) determined (Kuhn 1962). Some authors went as far as to argue that scientific truth is defined sociologically by consensus and trust (Shapin 1994), thus implying that the history of how scientific consensus is achieved solves the philosophical problem of truth by making it superfluous. The alarmingly called "science wars" of the mid-1990s confronted scientists and philosophers accused of naïve realism against sociologists and historians accused of crude constructivist relativism. While the excesses of propaganda on both sides is to blame for important misunderstandings, the debate had the advantage of presenting upfront a dilemma that is central to this chapter's investigation: how to take seriously historical insights about the role of wider technological, social, and cultural contexts in the history of science without reducing the sciences to their constructivist aspects.

4. $HS + PS = HPS$: non-reductionists interactions and attempts to found a new HPS field have been called for from many different perspectives, perhaps as many as there are understandings of the pursuits of both history and philosophy of science. A productive approach, or rather multiplicity of approaches, has been that of historical epistemology, with roots in the works of Bachelard and Georges Canguilhem and developed further in the last three decades in three directions: history of styles of reasoning such as probability (Hacking 1975), epistemic values like objectivity and observation (Daston and Galison 2007; Daston and Lunbeck 2011), and “biographies” of scientific objects such as electrons (Arabatzi 2007). While clearly not mainstream within philosophy of science, some philosophers interested in naturalized epistemology and in science in practice have thought about ways of adapting some of the tools coming from history of science without embracing historicism (Feest and Sturm 2011).

Most of these proposals focus on epistemology. There are, however, important attempts to tackle the ontological dimensions of the problem. These are the ones that interest me here most, for the goal of this chapter is to explore the significance of history of science to epistemological and ontological questions around materialism within the context of the present volume. Historians and philosophers interested in “historical ontology” have asked to what degree the very structure of the world depends of scientific developments. The standard realist response is that the (natural) world does not change, only our ideas about it (Hacking 1999). When Willard Van Orman Quine (1951) stated that sciences “continue the common-sense expedient of swelling ontology to simplify theory”, he was obviously talking about ontology in the rather very weak sense of worldview (which does not subtract epistemological significance to his thesis). Other harder versions of historical ontology have entertained the view that it is the world itself what results from the assemblages of humans and non-humans characteristic of scientific investigations (Latour 1999).

The main goal of this chapter is to vindicate the following as one of the most pressing open problems of philosophy in general, and not only of philosophy of science: how to make compatible a historical view of science that has ontological import, while avoiding the pitfalls of constructivism. The reason why this is in need of vindication is because a certain overdose of discussions on relativism and realism in the last part of the last century seems to have given way to an easy-going practical way of approaching the matter and a mutual ignorance of the respective takes on it by philosophers and historians. This sort of moratorium has enabled fruitful results and directed energies towards more subtle work on several directions. Nonetheless, it has not dissolved the problem. If anything, it has renewed its importance, for instance within discussions over climate science and string theory. Authors such as Bruno Latour, who had come to stand as representatives of hard (non-social) constructivist historical ontology, are now politically invested in preaching the virtues of science against climate change deniers (Latour 2019). Physicists in string theory have at times walked the opposite path, abandoning realism of theories and objects in favor of constructivist approaches (Romero 2020).

The hypothesis I want to discuss here, inspired in Gustavo Bueno's ontology, is that history of science is relevant for ontology (and for philosophy in general) inasmuch the sciences *enlarge the world* that philosophy attempts to comprehend. By world I mean here primarily the dimensions of reality which humans inhabit and perceive as distinct from the broader extra-human dimensions to which we have no access—we could call the first anthropic and even zoothropic dimensions, not in the sense of the strong or weak anthropic principle but in the sense of reality being filtered at the human perceptual and historical scales. Rather than two separate worlds, there are intersections between the anthropic and the non-anthropic dimensions of reality. In principle, to say that the world is enlarged is in a way just in reference to our representation of a preexisting reality which is out there regardless of humans (including scientists). But it is also more than that. Because our concepts and instruments are a result of our perceptual and historical constrains, so are most of the heterogeneous elements that make up a science and accompany its most objective claims. In other words, the open challenge I want to pose is to define objectivity and epistemological necessity once naïve realism has been debunked (if in the history of science and philosophy it ever existed in its crudest forms).

Most scientists and philosophers would agree today that scientific theories do not merely describe reality in any simple inception of the word. And, as I will discuss below, it is not very useful to regard neither the processes nor the results of scientific practice solely as those of greater correspondence between knowledge and reality. Moreover, a non-mentalist understanding of representation invites explorations on the ways sciences work and achieve their (partial) truths by transforming and connecting chunks of the world with other chunks of the world (a process that, as we will see through the example of oceanography, takes place in different ways in each science, but is by no means exclusive of the experimental sciences).

Because these transformations are primarily physically material (and only later mental, conceptual or abstract), the notion of matter and materialism is key to ontological understandings of the history of science. The larger point of the chapter is that discussions on materiality in the sciences could be more productive if ontology were more directly engaged. This essay is thus a plea for closer collaboration between historians and philosophers of science (Daston 2009). The first section of the chapter is devoted to reviewing the so-called “material turn” in history of science and related disciplines. While the renewed interest on matter is welcome, the next section argues, it needs further elaboration to be really relevant to philosophical discussions on epistemology and ontology. As such, philosophical reflections on “matter” deserve systematic attention if we are to avoid running in academic circles. In Sect. 8.3, I present the ontology of the philosopher Gustavo Bueno, in particular his discontinuous materialism, as a useful way forward to explore some of the ontological questions posed by the material turn in history and philosophy of science. By non-reductive I mean that Bueno's materialism, along with other philosophical materialisms, works with a notion of matter broader than the tangible objects that the “material turn” usually limits itself to. The question then becomes about how tangible materiality relates to other realities in the world, including non-tangible physical matter, psychic activity related to bodily operations,

and scientific concepts and non-scientific ideas. We can say that these realities are material in that they are plural and changeable and also in that their existence depends directly on the physical matter that supports them without exhausting them. That is, psychic entities are not spiritual and ideas and theories are not hypostasized eidetic entities. Bueno's ontology is useful in making sense of some of the results of the material turn in history of science. At the same time, however, it redefines rather than solving some of the open problems regarding the relationship between history of science and ontology.

Section four then uses the example of physical oceanography, largely neglected by philosophers, to illustrate the specific intertwining that those two notions (matter and truth) have in the sciences. The fifth and last section turns to the problem of scientific pluralism, regarding in particular the distinction between the so-called natural and formal sciences and human sciences. Again through the example of oceanography and the earth and environmental sciences more generally, I complicate that distinction by pointing to the way in which current scientists use history to understand changes in nature.

8.2 The Material Turn in the History of Science and Neighboring Disciplines

The divide between history of science and philosophy of science widened as the former took the social, cultural, and material turns. In the 1980s, the "material turn" in the history of science and the humanities more generally was a productive response to the excesses of the previous linguistic turn. While talk on "turns" is often a question of academic marketing more than a substantial description of intellectual developments, a number of philosophers in the last four decades have come to acknowledge the significance of matter and materiality in their attempts to comprehend the sciences beyond the formal logical analysis of empirical and theoretical propositions. In this section, I seek to introduce some of the main findings and pending questions within this surge of materiality and I conclude that further specifications are needed to make it ontologically meaningful.

There is no reason in principle to identify the historical development of sciences with the "history of science" as a discipline. Scholars have at times distinguished the scientists' history of science from that of the philosophers' and this one from the one of the historians, since every professional group selects and reconstructs certain aspects of the past according to their own interests. However, it is useful to attend to some trends in professional history of science which in the last four decades have revealed aspects of scientific development hitherto obscured by most accounts (including philosophical ones). In particular, from the institutionalization of the discipline until the last quarter of the twentieth century, historians of science had been mostly preoccupied with theory change. Physicists from Ernst Mach to Pierre Duhem had stressed the role of technology and apparatuses in

advancing and constraining scientific knowledge (Mach 1919[1883]; Duhem 1906; Ongay 2016). And the Marxist tradition had pointed to productive factors in trying to explain research priorities and capabilities (Hessen 1931; Farrington 1947). Among historians of science, Alistair Cameron Crombie (1953) stressed the role of experimental practice, which he claimed somewhat independent from theory in medieval times. But by mid-twentieth century mainstream history of science had become mostly a history of scientific theories, of how they were discovered, developed, and at times abandoned.

Alexandre Koyré (1939) is an oft cited example of the historical focus on worldviews, ideas, and theories over other aspects of the sciences (also, Burt 1924; Butterfield 1949). Among philosophers of science in the tradition of logical positivism (as diverse from one another as Popper and Hempel), the predominant interests on theory change effectively relegated the material world to a sort of repository of data against which hypothesis needed to be checked (Popper 1959[1935]; Hempel 1952). The material world was transparent for Hempel and tricky for Popper, but in both cases the functioning and properties of observation and experiment remained largely unexamined (Franklin 1986; Ferreirós 2010). The important contributions of Norwood Hanson (1958) and others to show that observations were theory-laden were a step towards more complex analyses, but one which again stressed theory over practices and materials.

The emphasis on theories over materials, practices, and operations was not challenged by the critics of the “modern inherited view”, such as Thomas Kuhn. Often credited to have revolutionized the history of science through his (to some extent social) history of revolutions, Kuhn was nevertheless also primarily invested in accounting for theory change. Further (and prior: Fleck 1979[1935]) developments of sociological history of science provided sociological justification to the results intellectual historians of Koyré’s kind had already offered (Osler 2010). While historians became used to see scientific ideas as part of a wider social and cultural context, they very rarely applied those insights to the history of experiments or apparatuses.

The focus on linguistic propositions introduced by the Vienna Circle and dominant in analytic philosophy of science was joined in the second half of the century by the linguistic turn of hermeneutic continental philosophy. Despite the rifts between these two traditions, to a certain extent they resembled one another in approaching knowledge about the world as a matter of analyzing discourses. Both counted also with important exceptions to this tendency. No less a figure than Martin Heidegger insisted, for all his obscurantist rhetoric, in the precedence of practice over language. On their part, historians and philosophers of technology had since at least Lewis Mumford linked technical developments to ideas about the world, including scientific ideas. But their discipline remained for the most part separated from the history of science and interested on science only as a source for technological innovation of economic import (Kline 1995).

This schematic summary does not hope to do justice to the rich twentieth century works in history and philosophy of science; it does seek to reflect the perception of these disciplines justifiably held by the philosophers and historians of science

who began to stress materiality in the 1980s. Perhaps the better known-argument is Ian Hacking's contribution to the scientific realism–antirealism debate. Hacking sought to displace this debate from theories and representation, moving it towards objects and intervention: “Electrons are real if I can spray them” (Hacking 1983). Conceptions of knowledge as mental representations have received serious critiques, including the impossibility (and undesirability) of a complete isomorphism, the unfeasibility of checking the representation against the represented (and the subsequent vicious circle), and the difficulties of accounting for connections between the two realms (Coopmans et al. 2014). Hacking and others stress instead causal continuities between entities (a notion I come back to in Sect. 8.4).

Other philosophers–historians contributed to the renewed interest in experimental practices in a movement often referred to as “new experimentalism”. Andrew Pickering famously described experimental work as an unpredictable dance with a constraining material world and distinguished three components whose interplay could help describe the dynamics of experiment: objects, apparatuses, and phenomena (Pickering 1995). Phenomena, rather than directly perceivable observations and anomalies feeding or falsifying theories, emerge as the product of observational and experimental practices, thus bringing transformative operations of materials to the forefront of epistemological analysis of science.

While I come back to this active view of phenomena below, here I would like to stress some of the ways in which the turn to experiments and, more generally, to objects, artifacts, operations, and materials has shaken traditional accounts of scientific historical development, while at the same time enabling competing interpretations as to what the material world really means epistemologically and ontologically.

From the point of view of the practice and epistemology of history, it is easier to work with texts than with practices, the records of which are usually gone with the wind. Treating historical texts as objects with their own materiality, however, enabled Reviel Netz (1999) to reconstruct bodily practices in Ancient geometry and to convincingly argue for the centrality of diagrams to Euclidean demonstrations and Aristotelian deductions. Historians and philosophers have since then expanded on the role of diagrams and texts in Ancient, early modern, and modern mathematics (Manders 2008; see also Madrid's chapter in this book and the relevant discussion section). Netz interprets his own work within extended cognition, the theory that humans think *with* their whole bodies and even *with* external objects. While theories of rationality have traditionally focused on the logical structure of arguments and theories, extended cognition seeks for it in the interplay between the hands and the objects around us. This has a subjective or phenomenological interpretation, in which what matters is the interaction between subjects and objects, as in technological phenomenology (Ihde 1990). But it also has an objective interpretation in which subjects become mediators between objects (Malafouris 2013). As philosopher David Baird (2004) noted, *knowledge* has come to encompass much more than the contents of a mind to include bodily repetitions, apparatuses, models, and physical representations.

The turn towards objects and operations has also been key in reshaping our understanding of early modern sciences. In alliance with social and cultural histories, object-centered histories follow *things* through society in and out alchemical laboratories, exploration vessels, artisanal workshops, merchants shops, and cabinets of curiosity. This has revealed relevant processes and actors hitherto obscured from histories of the scientific revolution, including machines (Shapin and Schaffer 1985; Meli 2006), artisans, and instrument makers and maintainers (Smith 2004; Werrett 2019), manual skills (Roberts et al. 2007), tacit knowledge (Long 2011), and traded goods (Cook 2007; Harkness 2007; Smith and Findlen 2002).

Among the many examples of the philosophical fruitfulness of this approach is Galileo's discovery of the moon's craters. Hanson, Kuhn and others have used this as an example of the "theoretical charge of experiment": while Tomas Hariot pointed a similarly powerful telescope to the moon and saw only observational artifacts, they argued, it was Copernicanism what equipped Galileo to interpret what he was seeing through his telescope as imperfections of the moon's surface. Samuel Edgerton (1984), on the contrary, has shown that the drawing techniques of chiaroscuro that Galileo had learned at the Academy of Design was what enabled him to paint and see the moon from a new perspective. Similarly, Robert Boyle did indeed draw from anti-Aristotelian philosophers such as Descartes and Gassendi, as intellectual historians stressed, but he also developed important insights on matter through his hand-on experiments at the *chymical* laboratory (Newman 2006).

Emphasis on experiments, apparatuses, and operations with objects has been even more productive for historians of modern sciences, particularly modern physics, where practitioners themselves have often stressed the epistemological significance of experimentation even when discussing theoretical principles (Seth 2010). The most relevant investigations have shown how political economy and culture have provided techniques and machines which have been transformative of disciplines' methods and results. An interesting example is statistics: developed in the early nineteenth century in political contexts, its methods were rapidly adopted by astronomers (Porter 1986). More surprisingly, in Germany statistics were interpreted from the point of view of historical rather than classical economics, and thus were applied to socio-historical groups rather than to individuals. This was at the time a much debated interpretation that Boltzmann was well aware of when developing statistical mechanics and the probabilistic interpretation of the second law of thermodynamics (Boltzmann 1974[1904]).

Another example also concerning thermodynamics speaks even more directly of the productive results of the material turn. In his studies of the "simultaneous discovery" of the first two laws of thermodynamics in Great Britain and Prussia, Thomas Kuhn showed the role of engines as energy "conversion devices", transforming heat into mechanical energy (Kuhn 1977). Kuhn's argument is nothing like the social relativist constructivism outlined in some other works by him and in some interpretations of them—the notion of "simultaneous discovery" already points to a preexisting reference being discovered. Nonetheless, Kuhn aptly shows how the magnitude *work* proposed by Helmholtz and others to commensurate all forces of nature by measuring transfers of energy made direct reference to the need

of comparing the “duty” of steam, water, wind, electromagnetic, and animal labor, i.e. their respective capacities of lifting a weight.

This connection is most clear in Helmholtz (1995[1847]), who defined work as *force x distance*, a relationship directly taken from the engineering tradition and its interest in the energy of motion. Historian Norton Wise took Kuhn’s intuition further stressing how at least since Carnot (who presented his theoretical perfect heat engine in an engineering volume concerning efficiency) the notion of “work” combined physical and moral meanings directly related to engine’s efficiency and waste, the two main notions involved in the first (conservation and transformation of energy) and second laws (entropy) of thermodynamics (Wise 1989–1990). The “external” becomes “internal” (on the distinction between internal and external history of science and the ways it can be superseded, Hueriga 1999). Also within thermodynamics, Diana Kormos Barkan (1999) showed through her study of Walther Nernst that physical chemists developed what came to be known as the third law in the context of manufacturing incandescent lamps.

The laws of thermodynamics, however, present a level of generality greater than that of their contexts of origin. The physical concepts of work and energy emerged within local machinic, economic, and political milieus. This makes us already very cautious against attempts to find precursors or predecessors of modern physics in, for instance, Presocratic fragments or in Christian theology. While ideas and concepts may resemble one another and even act as inspirational for modern scientists, the dense networks of apparatuses, practices and auxiliary theories make the references (conservation of mass or energy, for instance) completely alien. This is to recognize the historicity of scientific truths, or rather that they can only emerge in certain cultural, technological, and conceptual circumstances. But this, in turn, poses the core problem of this chapter, a problem similar to the one encountered by historians and philosophers inquiring about diagrams in Ancient geometry: how do we account for the generality and necessity of the structural results of a science?

A not fully satisfactorily answer put forward by some authors also stresses materiality: “universality derives from the circulation of particulars” (O’Connell 1993). This is roughly Schaffer’s (1989) solution to the failure of Newton’s *experimentum crucis* on light decomposition: it only worked if one used the same glass prism as Newton. This comes to reproduce the Duhem–Quine thesis at the experimental level, in a vicious circle that sociologists Harry Collins (1992) called “the experimenter’s regress”. That is, scientific validity depends on a set not only of theoretical assumptions but on the travels of functioning media and instruments without which laws, theorems, and scientific entities vanish (Cartwright 1983).

Take this to its last constructivist consequences and you have Latour’s argument that Ramses II died on tuberculosis only inasmuch as he was brought into a laboratory context in which Kock’s bacillus was a well-established category and could be isolated (Latour 2000). Recovering the material world has called the attention of historians and philosophers of science to the roles that extra-theoretical entities play in scientific fields. But it has also reformulated philosophical questions (to stick to the three mentioned above: representation, decidability of experimental results, and realism of entities and theories). The next section briefly argues against

attempts to secluding or silencing those questions in the name of post-humanist flat ontologies of becoming.

8.3 Can We Get Our Philosophical Materialism Back, Please?

In his article “Can we get our materialism back, please?” Bruno Latour (2007) proposed to rescue the term “materialism” from its ideological kidnapping by historical materialists. Rather than trying to account for human history, including history of human knowledge, from the abstract view of macro-economics, Latour proposed that materialism should go back to concrete *things*. Latour has a point. As undefined as it is, the concept of “things” has the advantage of retaining the human scale through which we access the material world—an atom and the solar system are hardly “things” or they are so only indirectly through the mediation of actual tangible and perceivable things. A number of authors have called attention to elements and compounds in the microlevel to understand the role of materials in history of science and human history more generally (Roberts 2018; Hecht 2018). Others, including examples from the previous section, have stressed human practices such as experiments or observations as the locus where phenomena are produced, sometimes exceeding human temporal and physical scales. And yet, both micro and macro scales are only accessible to us through bodily operations with things. The criteria Latour is offering seems thus not far removed from Bridgman’s operationalism proposed in 1927 (Bridgman 1927), when work on elemental particles was exacerbating idealist approaches to causality, determinism, and rationality.

The problem with Latour’s proposal lies elsewhere: in its self-imposed limitation. Limiting materialism to the study of things throws the bathwater of historical materialism away, but also the baby of philosophical materialism with it. It leaves pressing questions in epistemology and ontology completely undecided. Latour himself seems to have conflicting opinions on both realms. In epistemology, he has switched a sort of constructivism in which, against the social-reductionist Strong Program, subjects and objects are co-produced (Latour 1999) for a wholehearted defense of the urgent truth of scientific results in face of the political import of climate change (Latour 2019). Regarding ontology, Latour joins other scholars in proposing a flat non-hierarchical ontology in which (both human and non-human) *actants* form the (simultaneously natural and artificial) *assemblages* which constitute the world. Similar examples abound among the so-called new materialisms (for instance, Rowlands 2005). And yet, a flat ontology which avoids distinctions, classifications, and decisions on whether scientific results are true beyond a specific setting and in what way is hardly an ontology at all. Or, better put, it is an ontology in that it transcends scientific results and reflects upon them and the world, but one which leaves too many questions open (Harman 2009). Worst, it seeks immunity against such questions.

The focus on matter (things, elements, operations, experiments, technologies, and phenomena) is not enough to dissolve core discussions in philosophy of science. Talk of materiality and materialism pervades a number of disciplines, but it does so in so heterogeneous and undefined ways as to encompass both physical reductionism and a number of “new materialisms” that actually defend a social constructionism (see Harman’s and Pérez-Jara’s discussion in this volume). “Materiality” talk faces the same ontological ambiguities as Bridgman’s operationalism before it (Bunge 1988). Work on historical ontologies as ontologies of *becoming* rather than of *being* and on biographies of scientific objects are incredibly productive, but their authors would rarely go as far as to say that scientific entities did not exist before their discovery. They just renounce to analyze the question of how local knowledge which has been produced under very precise historical and technological conditions can actually refer to something about the world beyond human knowledge of it. To be clear, this is a fair decision to make by those less interested in metaphysics or skeptical about its results, and it is not my intention to restore the dualistic subject/object distinction or an uncritical defense of science as representation. But the material turn is a good opportunity to reanalyze ontological and epistemological issues regarding sciences from a view that is both historical and practice-based.

The first question open by the material turn is precisely about matter. For materialist ontologies, the plea to focus on materiality should be followed by the question of what else there is besides mater. Anthropologist Tim Ingold (2011), for instance, has noted that talk on “materiality” has come to reproduce the divide between an allegedly *formless* material world and a sort of spiritual world of human culture, meaning, and reason which acts *upon* the material world from the outside. Other authors have noted that the surge of materiality in various humanist disciplines seems to be in opposition to “other classes of objects or processes which may be labeled ‘non-material’, ‘virtual’, ‘theoretical’, ‘formal’, ‘mathematical’, ‘ideational’ or the like” (Tilley 2004). But defining materiality by objectual tangibility seems an unjustified reductionism. Even within the realm of physical matter, elemental particles and electromagnetic waves and fields, for instance, are hardly tangible in any usual sense of the world, but there is little reason to call them anything other than material. The inclusive materialisms of Mario Bunge and Gustavo Bueno discussed in other chapters of this volume go further in incorporating psychical and ideational processes into the realm of materiality, at least in the sense of being plural and changeable. By contrast, exclusive materialisms eliminate psychic life and eidetic entities either by denying their existence or by reducing them to physical matter. But attempts at reduction have largely failed (Bunge 2010; Bueno 2019). Inclusive materialisms have the advantage of highlighting the constitutive connections between ideas or theories and physical materiality. This enables fruitful analyses of the interplay of continuities and discontinuities that constitute our universe (see Pérez-Jara’s chapter in this volume).

It seems that more than a flat ontology is needed to deal with such an irreducible plurality of material entities while simultaneously accounting for connections. Take for instance John Dupré’s fruitful thesis that the world is disordered, that

is, devoid of immutable essences, reductive entities, and deterministic causes. Because of his realism, this enables him to present the plurality of science as derived from the disorder of things (Dupré 1993). Against the reductionist dreams of an unified science, this perspective is certainly welcome and worth exploring. And yet, this radical epistemological and ontological pluralism of disconnected kinds of things runs into problems very similar to those of a flat ontology of things. In particular, it has a hard time reconstructing continuities established across structural discontinuities. Take for instance the idea of the human family. As Mario Bunge has pointed out from a pluralist perspective, an approach to the human family that is epistemologically and ontologically meaningful should take into account diverse dimensions or levels which are nonetheless irreducible to one another, including biology, psychology, sociology, demography, and politics (Bunge 2003; see also Pérez-Jara's in the discussion chapter of this book). It seems like the dichotomy monism—essentialism/pluralism—disorder is too simplistic. Any pluralist non-reductionist ontology that seeks to account for scientific results needs to also be attentive to structural continuities. There are, moreover, different types of continuities as well as of discontinuities which require both the empirical analysis of assemblages and the fine tools of ontological classification.

A second question regards the epistemological status of the notions of representation and truth. As philosopher and historian José Ferreirós argues regarding the “experimenter’s regress”, attention to experimental practice can yield much more than a mere reinterpretation of the Duhem–Quine thesis. If the focus is switched from propagandistic *experimentum crucis* to series of experiments yielding equivalent results under different conditions, the alleged vicious circle transforms itself into a virtuous one (an helix, in Ferreirós’ wording). This can more appropriately account for actual advancements of knowledge than sole reference to social authority and trust (Ferreirós 2010). It is clear that attention to things and to operations with things does not exhaust philosophical interpretations.

The next section analyzes these ontological and epistemological questions together, attending to the notion of matter around the question of what is specific about scientific instruments and apparatuses. More precisely, given that the material turn has shown the intersections of scientific operations with other bodily practices with things, we can ask what is specific about scientific operations and scientific things that explains how they give way to the discovery of objective or necessary relationships.

8.4 The Hypothesis of Discontinuous Materialism

The philosophical importance of the material turn in history of science, science studies, and philosophy of science has been sometimes interpreted as a descent from formal to material languages (Suárez 2019). In Carnap’s terms, material languages refer to the actual state of the world and formal languages to the very languages with which we analyze entities and their properties. Only formal languages are

properly theoretical and philosophical. Hacking, Cartwright and others would be limiting their realism to the first realm, to entities rather than to theories. The problem with this interpretation (and with the Carnap's terminology that inspires it) is its rather uncritical reproduction of the traditional distinction between matter and form. Aristoteles introduced the distinction as part of an ontology that we no longer accept. It was then appropriated by different schools throughout the philosophical tradition, each of which understood very different things by "matter" and "form". For instance, Aristotelians and neopositivists emphasize logical forms, scholastics conceptual ones, Kantians transcendental forms and neo-Kantians physiological or psychological forms, Pythagorean and Newtonians mathematical forms, and historicists social and cultural forms. What is paradoxical about the present moment is that all the talk about matter and materiality has not been accompanied by a corresponding theorization of form. As Ingold (quoted above) warned, this comes to restate the distinction between a *formless* passive matter and an active human spirit which invests forms—a *dator formarum*.

What I want to propose here is that rich ontological understandings of matter can make the most out of the material turn. In particular, inclusive materialisms do away with the idea of a passive uniform matter independent from forms. For Mario Bunge's systemic or emergent materialism, material systems of different ontological levels (physical, chemical, biological, social...) are characterized by specific components, structures, mechanisms, and contours (Bunge 2003). Gustavo Bueno's discontinuous materialism, in turn, presents an ontology of three distinct genera of matter: physical (including here chemical and psyche-less biological matter), psychical, and eidetic or abstract (Bueno 1972). The latter two depend on the first while cannot be reduced to it and are plural and changeable. While irreducible to one another (and therefore discontinuous in important aspects), together they form the human world which sciences seek to understand and work with and *enlarge* with new objects, phenomena, and theoretical results. They are in this sense historical.

Perhaps one of the main differences between Bunge's and Bueno's ontological approaches is that for Bunge physical matter is a primordial reality, whereas for Bueno there is an unknown material reality from which physical matter would have arisen (which means that we do not have reasons to hold that the universe exhausts reality in general). Bueno called it general—ontological matter, of which we have a limited and mainly negative knowledge. This is very relevant to philosophy of science, because there is no reason in principle for sciences to grant us access to that primordial reality. And yet every time a scientific theory allows us to go beyond our organoleptic and cultural—historical scales, for instance postulating a microlevel reconstructed from our macroscale or postulating a time before psychical life, we can say that the human world incorporates or accesses that primordial reality while filtering it to its own terms and scales. The relationship between the anthropic reality (bodily and historical) and the primordial non-anthropic reality is an open problem to any philosophy at least after Hume (see Pérez-Jara's chapter in this volume). This problem is very relevant to the main question of this chapter—the relevance of history of science to ontology. But it does not exhaust it. The ontology relevant to

the anthropic dimensions of reality, to which sciences refer in principle, is already mobilized by the questions raised by the historicity of scientific objects and theories.

A second important difference between Bunge's and Bueno's materialism is perhaps just one of emphasis: while Bunge's focus is mostly in propositional theories, Bueno stresses that human activity in the world, including scientific activity, is primarily practical and only later theoretical. Regarding scientific knowledge, this means that the physical material objects with which scientists operate to build their theories are as much the products of nature as they are of our organic perceptual organs and of millennia of practical categorization, production, and reworking (Bueno 1991–1993; Bueno 2013).

This is perfectly in line with the material turn in the history and philosophy of science. But what non-reductionist materialism quickly adds is that it makes no sense to talk about matter as detached from form. Matter (in the physical-objectual sense of the material turn) is thus always *in-formed* (to turn the Scholastic phrase against the Scholastic idea of separated forms). This is just making explicit the assumption that has likely led to the above-mentioned apparent paradox that the material turn has not been accompanied by a theorization of form. One of the reasons for the effective abandonment of forms in the last decades (an idea central to most of the philosophical tradition) is precisely the realization that they do not exist without matter. Bueno dubbed his gnoseology “circular” to emphasize precisely this overcoming of the distinction between matter and form. Matter and form are inseparable for two reasons. On the one hand, matter is always structured and imbued with properties. On the other, forms without matter have place only in the Platonists' imagination.

This comes to deny Carnap's distinction between material languages and formal-theoretical languages. If Hacking's and Cartwright's arguments are valid in the (physical) material realm, then they ought to also be valid in the formal level, because scientific formal languages need to incorporate the material world in some manner. There is no way to “spray” electrons without a language that reinterprets the phenomena within the structural mesh of the field of elemental particle physics. Scientific propositional theories relate linguistic signs which are semantically pegged to objects. Because of this, propositional relationships convey unforeseen relationships between objects. What is specific to the sciences is that on occasions these relationships are necessary despite having developed in operational contexts. Moreover, it is precisely specific meshes of objects, signs, theories and practices what differentiate scientific fields from one another and also facilitate their mutual contact. The material world thus enters each field cut at the specific scale of the field's terms, such as geometrical figures, chemical elements, and neurotransmitters. According to Bueno, each scientific field constitutes a categorical closure in that it defines a circle or category of immanence in which operations with kinds of terms cut at the field's scale give way to the same kinds of terms. This of course does not exclude the many synchronic and diachronic interactions between scientific fields, but it does help understand some of the structural discontinuities among them. The plurality of scientific fields thus stems from them being ontological and historical–practical configurations without reference to which it makes little sense to speak

of scientific truths. Democritus' atomism and Dalton's atomism have important analogies with one another, but also enormous differences as the second operates with chemical elements and the law of conservation of mass.

Moreover, each scientific field counts with specific artificial configurations which enable establishing operations and relationships among its terms. These constraining frameworks (that Bueno called "determinant contexts") are technological, but also semiotic and linguistic, and they include from the circle of Euclidean geometry to the air-pump of Boyle's experiments with void. Constraining frameworks come in many shapes in different disciplines. But there are good reasons to think that they also exist for observational sciences working with objects with which we cannot operate directly. For instance, Kepler's ellipses result in the projection of planetary movements in the paper, where plane geometry acts as a determinant context (Bueno 1991–1993). Similar considerations apply to oceanography, as the next section discusses.

To pick again the example of thermodynamics, engines and incandescent bulbs are the local and historically contingent technologies where the relationships between heated bodies and cold ones gave way to the precise formulation of the physical concept of work, later abstracted and applied to further contexts (including the whole universe, in Victorian debates about the age of the sun filled with myth as much as with science: see Smith and Wise 1989; Smith 1998). The engine becomes a sort of *phenomenological machine*. It technologically transforms different substances and their properties to the terms of heat differentials and enables precise operations which yield theoretical concepts such as work. The direct reference of these concepts are the material relationships of bodies within the engine (for instance, being lift by it).

Peter Galison (2003) described Albert Einstein's involvement with clocks in similar terms: Einstein formulated his theory of special relativity in a context characterized by the problem of how to coordinate different clocks without a central reference. While these constraining frameworks help define the scale in which worldly entities enter as terms of a scientific field, they also sometimes function as mediating machines between different fields, as the balance did for a number of late eighteenth century disciplines (Wise 1992). Cartwright's *nomological machines* are similar to these constraining frameworks, but her argument that the laws of physics only work within them is too limiting. Because precisely what is powerful about (at least some) scientific results is that they acquire a logical and ontological necessity beyond their context of origin. The Pythagoras theorem does not make reference to any particular diagram as the first and second law of thermodynamics refer to much more than the engines where they originated. Accounting for this is perhaps the hardest challenge to the history and philosophy of science.

Developing Gaston Bachelard's notion of "phenomenotechniques", historian and philosopher Hans-Jörg Rheinberger (2005; 2010c) has shown that microbiological preparations, much like chemical ones, give way to stable interactions between the prepared materials which, in his terminology, crystallize into *epistemic things*. According to this, what is specific to the sciences is the process by which the (historically-situated) operations that give rise to particular relationships between

the terms of a given field become segregated or offset. This is at the core of Bueno's theory of science. It is also at the core of this chapter's central question about the ontological import of history of science. It is through historically constituted scientific fields and historically contingent constraining configurations that the objective and logically necessary results characteristic of the sciences emerge.

One of the open questions for Bueno's discontinuous materialism is in what sense these results refer to the non-human dimensions of reality that are primordial relative to the three genera of matter—which are defined at the anthropic scale. Recognizing that the world which we perceive and which the sciences enlarge is not the absolute world is a central tenet of discontinuous materialism against both idealism and reductive materialism. It underlies that animals and humans introduce certain epistemological distortions in the world as they sense it and categorize it and, simultaneously, that the reality underlying their perceptions would subsist without them. This means that ontological—general matter is a negative reverse of the anthropic reality configured through the three genera of materiality, which already incorporate the perceptual and historical scales of our perceptions and productions. The ontological version of the gnoseological problem is thus to determine what kinds of discontinuities and continuities can we establish between the anthropic dimensions of reality and its non-anthropic ones.

Rather than trying to solve it or dissolve it, I present this question here as a problem which materialist philosophies share with idealist ones. Historically emergent scientific results refer primarily to the ontology of the anthropic world. But, unlike historicists would have it, inasmuch as scientific results attain truth status, they open this anthropic world onto larger portions of the non-anthropic reality without exhausting it. This completely redefines the problem of the relationships between history of science and ontology. At the same time, it opens rich questions about the relationships of historically constituted scientific fields (including the scale of the terms and the necessity of their results) and the primordial reality that supports them.

Hume reopened a divide which had already appeared repeatedly in history of philosophy from Ancient thinkers to Scholastics and which led to Kantian critical transcendental idealism and its separation of the worlds of noumena and phenomena. Since then, most philosophers of science have struggled with the distinction. Take August Comte, who is generally recognized as the father of positivism identified with the confidence that sciences will uncover the structure of the world. And yet, Comte was very clear in that he was not referring to the absolute non-anthropic structure, which would ultimately be unattainable. Our senses limit our access to that absolute reality (Comte 1844, 14). And historical—sociological frameworks completely change the way facts are interpreted—what is a sign or a miracle for the theological thinker is part of a phenomenological law for the positivist thinker. Of course, for Comte not all interpretations are on equal foot regarding their truth, and he privileged the positivist stadium he saw himself as championing. But humans would never be completely able to encompass absolute reality (Comte 1844, 13).

The distinction between a human and an absolute reality was of course central to phenomenologists (from Ernst Mach to Edmund Husserl and Martin Heidegger, of course for each in a very different way) and conventionalists (like Henri Poincaré and Pierre Duhem), but it was also present among the neopositivists. Deeming as meaningless the problem of a reality non-reducible to that of experience is not the same as saying that experience exhausts the absolute reality, as Wittgenstein and others insisted (Hahn et al. 1973[1929]).

Discontinuous materialism accepts the distinction between reality's non-anthropocentric and anthropocentric dimensions. But, against idealist interpretations, it does not separate them into two worlds. Rather, it proposes an interplay of continuities and discontinuities which enables it to pose the question of how the objective results of sciences reflect non-anthropocentric realities or in some way extend the anthropocentric dimensions of reality into the non-anthropocentric ones. This problem, as central as it is, does not exhaust this chapter's question about the connections between ontology and epistemology. The question of determining in which ways human operations with physical matter give rise to the stable eidetic level of scientific results already mobilizes the connections between ontology and epistemology. The next section puts some of these concepts to work in the analysis of a science not usually at the center of philosophical discussions.

8.5 The Example of Physical Oceanography

While examples from physics and biology abound, oceanography is not a science that has received much attention from philosophy. But histories of oceanography—written by oceanographers themselves and by professional historians—are abundant enough to account for the development of this field as a distinct way of simultaneously transforming and capturing reality. Limiting my analysis to physical oceanography, and in particular to the dynamics of currents, takes us back to the navigators who were knowledgeable about the velocity of superficial currents and who developed techniques to measure them, however roughly and locally. In the nineteenth century the extension of global maritime empires, commerce, and the steamship attracted more people and resources interested in standardizing global measures and attempting to provide some mathematical relationship of superficial currents and winds. For most of the century, however, most worked under the assumption that deep waters were still, too cold and too heavy to move and to sustain life. It was not until surveyors working on telegraph cables greatly improved sounding methods and their ability to bring samples ashore that the varieties of temperatures of the deep ocean became evident. William Carpenter first demonstrated the existence of deep currents in a sufficiently convincing way to end the controversy. He immediately proposed to account for circulation with a physical model in which convection and not wind velocity was the main driver. While Carpenter's theory was rejected, his model served as a constraining framework where the behavior of different masses of water was regulated by temperature

differentials (Camprubí 2018). It also became clear that salinity enabled identifying water masses and telling them apart from one another, at times despite their physical proximity (for example to identify Mediterranean waters navigating in the North Atlantic).

At this stage, physical oceanography had not yet crystalized as a scientific field, but together with navigators and surveyors, scientists were already configuring oceanic materialities through samples recovered from sounding lines launched from ships. Perfecting this sampling technologies has been to the present the main way humans had access to deep waters. This is epistemologically significant. Samples remove some molecules of water from their pristine natural context. Then, temperature and salinity readings numerically abstract those water samples (Helmreich 2019). Moreover, temperature readings are clearly transformative in that the thermometer facilitates the conversion of a property of water into a mark on the line of the mercury water column, which is then comparable to other similar marks in a standardized way. Sampling methods today do not greatly differ from those early ones. Conductivity–temperature–density (CTD) recordings provide data in digitized forms and are often carried by self-buoyant drifts which automatically ascend to the surface to send them via satellite (Goodwin 1995). But the magnitudes relevant for the samples and the data organizing the materials of physical oceanography have not greatly changed. They constitute the characteristic scales of the terms of this scientific field.

In the turn of the nineteenth to the twentieth century, borrowing methods from meteorology enabled Scandinavian scientists to find stable relationships between the variables that had been defined in the samples: temperature and salinity (Hamblin 2014). They developed the since then ubiquitous T/S diagrams. These functioned as *constraining frameworks* enabling relationships between data on temperature and salinity obtained from samples. Taken as proxies for bodies of water, the T/S diagrams made possible the first mathematized description of the dynamics of flow at basin and even global levels. Here, as the T/S diagram is written in paper, emerges a kind of relationships between bodies of water which is not in nature as such (it abstracts the very complex reality it says to represent), and yet it is logically necessary in that it segregates the scientists' operations which put it in place. Take for instance the identification between the water sinking at the Poles and that rising at the Equator. It adds something novel in both epistemological and ontological senses, because the samples of water taken in these two regions were obviously not the same and thus their connection is in some extent over imposed within the T/S diagram. And yet these relationship of material identity cannot be viewed as just the scientist's construction. Moreover, other technologies, particularly active sonar, enable cross-checking and calibration because the propagation of sound underwater varies with temperature and density. The circulation of cold and warm waters closes a circle which can now be said to encompass the locality of the samples and of the instrumental operations of transformation.

“Circle” here is not only meant in the literal sense of oceanic convection, but in the metaphorical one of Bueno's categorical closures. Certain kinds of entities and their properties enter into the scientific category of physical oceanography by

being transformed into its scale and thus being able to correlate themselves with other entities cut to the same scale. In the process, relationships between those terms emerge in ways that allow for abstracting the scientists' operations. This means that the circle is virtuous in that it has given way to scientific truths (of varying degrees of stability and generality). Scientists are still needed to (among other things) collect samples, measure data, and develop T/S diagrams. But this operational scale is abstracted from the relationships between bodies of water and their movements established within the T/S diagram. These relationships, however, are always partial, abstracted, and coexist with others given at different scales, a topic to which I return below.

That historically situated apparatuses, magnitudes of measurement, and calculating techniques define relationships between bodies of water means that (the history of) sciences and epistemology play a role in shaping the anthropic world. But it also means that it does so guided by materials themselves and their relationships. The historical contingency of the scales of the terms and constraining frameworks onto which objects and their properties are converted cannot be arbitrary. Rather, the very fact that these constraining frameworks yield structural relationships depends on some kind of adjustment to a world independent from humans. The relationship to that reality is not primarily one of a representation but of transformation. In other words, representation only makes epistemological sense under certain conditions of material continuity. The relationship between theories and reality is one of successive operational transformations through which structural relationships emerge.

In one of the few existing philosophical accounts of oceanography, Gregor Halfmann argues that:

Ocean scientists create material samples by inducing a “material integration” of physical parts of the ocean ecosystems and physical parts of the sampling technology. The fusion of materials from different origins is the formation of a novel entity with distinct characteristics that take shape in the process of sampling. Preserving the newly created object throughout the epistemic process constitutes “material continuity”, which is crucial for the creation of data in my case.¹

Samples are thus physical referentials which, through a series of operational transformations within constraining frameworks, are processed into data cut at the relevant magnitudes (in the case of physical oceanography, of temperature and salinity). That these data are often numerical *signs* enables mathematical calculations. As Lisa Gitelman (2013) put it boldly, “raw data is an oxymoron”. Earth and environmental scientists dealing with global scales and change throughout time are well aware of data's lack of immediacy. As Paul Edwards (2010) showed for climate sciences, data processing goes all the way up to the level of modeling, so that the models that result from the data are in turn used to calibrate data sources and to adjust for data mismatches and (often huge) temporal and geographical gaps. The

¹ Halfmann (2018), 37.

vicious circle, sometimes inevitable, is avoided when alternative sources confirm the models, which in any case are constantly subject to revisions.

This means that scientific abstractions result from series of continuous transformations of parts of the world. What distinguishes scientific theories from other types of theories is perhaps the ways in which the first incorporate the world itself. But of course this is a matter of degree. Moreover, error and missing links commonly appear in this operational transformations. The distinction between the material world and the theoretical constructs around it appears at certain levels of theoretical abstraction, particularly when theory—change reveals the inconsistencies of previous frameworks. In the case of physical oceanography causal theories of thermohaline circulation (driven by density differentials as distinct from wind-triggered superficial circulation) have succeeded one another and adjusted to varying temporal and geographical scales. William Carpenter's late-nineteenth century "generalization" of his understanding of Gibraltar has not survived. The so-called conveyor belt of world ocean circulation, proposed a mere four decades ago, is now regarded as an approximate model more than a faithful description of a rather messy situation in which whirlpools and gyres introduce chaos, turbulences and fluctuations. As it often happens in science, the closer the resolution, the messier the picture. The difference between scientific truth and scientific error is always local and retrospective, and often a matter of degree in which past inaccuracies paved the way to present knowledge. This is so because often the material relationships which accompanied past theoretical approximations remain and their past interpretations are somehow subsumed into the new ones. Scientific truth, and the ontology it carries, is processual, and in this sense the history of science has import for the philosophy of science but also for philosophy in general.

8.6 Distinguishing Between Human and Non-Human Sciences in the Anthropocene

As interpreted here, turning to technologies, objects, and operations in the history of science enables new understandings of sciences within their cultures of origin while at the same time avoiding the excesses of social constructivism. The latter is possible inasmuch as the relationships among the different materials reach a sort of independence from the operations that brought them into being, so that retrospectively they reveal themselves as a discovery of preexisting entities, relationships, and properties. This is a very schematic picture. The specifics of this process vary immensely from science to science and even within each scientific field. For instance, the way materiality establishes continuities in sciences that work with classifications would be different from those which work with models. And many more elements that the ones reviewed in this paper would need to be taken into account and then analyzed in the concreteness of each science's historical development. In particular, the way signs (mathematical or otherwise) mediate

between different objects is among the most intricate problems in philosophy of science. Its analysis could provide a middle ground between the linguistic and the material turns. To map this and other complex aspects of scientific knowledge, philosophers can turn both to scientists themselves as well as to historians of science and nearby disciplines.

But the goal of this chapter is only to gauge and move beyond the (otherwise welcome) operationalist plea to consider apparatuses. I do so by arguing that what is specific to the sciences is that, through operational transformations of reality's contents, they give way to structures that reach certain levels of necessity beyond the operations of origin. These structures can even refer to objectual relationships in a reality previous to or independent from humans. The kind of logical necessity specific to the sciences is enabled by the suppression (rather, abstraction) of the subjects who have facilitated the material relationship between objects.

This criterium of demarcation is descriptive rather than normative. And the extent to which objectual relationships reach certain independence from the subject's operations is a matter of degree across different disciplines. The productiveness of the criterium, however, appears already in its first consequence: human and animal sciences do not suppress all operations in their fields in the same way that the so-called natural and formal sciences do. This is not to say that certainties cannot be established in the human and animal sciences. It only means that by definition, animal and human sciences study processes of behavior, agency, and choice to which organisms and their respective perceptions of the world around them are constitutive. If these operatory scales are removed in favor of substrata (as in neurophysiology) or suprastrata (as in structuralism), the configurations of origin fade to the point of impeding their study (Bueno 2013). To be successfully reapplied to the original materials, subjectual operations need to be incorporated back again. There are of course other approaches to the peculiarities of the human sciences (Hacking 1996). The one offered here has the advantage of retaining a high level of generality (applicable even to the animal sciences) through the very concrete criterium of whether operations are part of a field's subject matters.

Notwithstanding the fruitfulness of this operationalist and materialist criterium in accounting for the peculiar rhythms and results of the human and animal sciences, I would like to devote this brief last section to a way in which recent developments in the sciences complicate it even further. There are sciences which combine the search for objective and necessary relationships beyond subjects with the inclusion of animal and human operations as objects of studies. Epidemiology is a good example. Take for instance the global spread of the COVID-19 pandemic. While the biomolecular properties of coronavirus are key to understand transmission between organisms and thus to predict contagion rates, epidemiological models need to take into account sociological factors (such as social gatherings) as well as political decisions made by public health officials (such as testing and confinement). Epidemiology is thus inherently imperialistic, as it includes ever larger factors of risk into its explanations of the spread of diseases in populations (Broadbent 2013).

This kind of mixed situation is present in less obvious cases. For instance, important aspects of evolutionary biology depend on the ethological operations

of animals as “natural selectors” seeking for sexual partners or for prey. Certain sciences, however, are often thought to be objective all the way through in this very precise sense of not formally including animal or human operations into their objects of analysis. In particular, the earth sciences were traditionally as removed from operations as is physics. Disciplines like geology or paleontology were historical from the onset, but only in the broad sense of describing unique time-dependent processes in which strata played roles similar to the archive for the historian and explanation often read like narrative. Other among the so-called natural sciences have lately also moved towards historical explanations in this sense. They often do so through technologies of computer simulation which allow, for instance, crystallographers to “grow” crystals and describe each new step in their development as resulting from the previous one (Wise 2011). But, unlike historical narratives, in these accounts of growth there are no agents; geologists and oceanographers do not need to deal with subjectual purposes and actions more than the crystallographer.

In the past few decades, however, this situation has changed. Human history has become integral to several aspects of the earth and environmental sciences. The rise of the ecosystem and biosphere concepts, as well as of the idea of the global environment and of Earth System Sciences (a cluster of disciplines partly based on Lovelock’s *Gaya hypothesis*) already put a significant weight on the shoulders of organisms whose daily activities had transformative powers in the chemical composition of the atmosphere and other local and global processes (Dutreuil 2018). But it has been the notion of anthropogenic change which has brought human history to the equations of the earth and environmental scientists. Pollution, ozone depletion, acidification, nuclear waste, eutrophication, and climate change are processes in which human history and political economy is recognized to have a significant impact. Geologists discuss whether we live in a new Anthropocene era. But less spectacular and less debated developments have filled the earth and environmental sciences with mentions to human activity.

Let me return to the example of physical oceanography. Along the twentieth century, and through the T/S diagrams described above, charting currents and bodies of water was done at different temporal and geographical scales. Partly driven by the necessity of locating and predicting the behavior of layers of temperature for anti-submarine warfare, studies of small fluctuations multiplied during the Cold War. They greatly complicated previous accounts of the dynamics of circulation, which had defined relatively stable relationships between large and slowly moving bodies of water and had established causal ties to wind for superficial currents and density differentials for deep waters (thermohaline circulation). The conveyor belt is an utmost example of this approach, seemingly tying together the whole world ocean in a steady long-term cycle. Zooming in both geographically and temporally yielded more movable identities and causal relationships. Small local turbulences were now seen as able to trigger larger regional effects, but also longer term processes rendered cycles of convection and thermohaline circulation less stable than previously thought. In particular, as the Earth System Sciences called attention to interactions of atmospheric and oceanic chemistry and to changing equilibria, in

the early 1990s new studies were designed to tackle century and decadal changes in temperature affecting circulation (Wunsch 1992).

From then onwards, oceanographic practices and methods have changed substantially. The shift, enabled by digital and satellite technologies, has been from describing the dynamics of circulation to monitor their change through massively and continuously collecting data which are in constant interaction with models of rising temperatures and moving waters (Roemmich et al. 2019). Several major changes of regional dynamics of circulation have been identified in real time, and others have been demonstrated retrospectively (Parrilla 1994). Climate change is proven to have a role on these. And this has led oceanographers to questions about fossil fuels and carbon capture which inevitably incorporate human history. While this move is also the case in geology (for instance in ice core research), atmospheric sciences, climate science, and other related disciplines, it is even more visible in the environmental sciences. Historical ecology is one of the new mixed sciences. In it, biospheric changes such as forestry development are related to human activity, and methodologies for its study involve both archival research for untapping documents and artifacts produced through human engagement with the natural world as well as mathematical models and digital simulations to map patterns of commerce and migration. The operational distinction between the sciences allows for a pluralistic approach in which objectual and subjectual methodologies interact and move across the sciences.

8.7 Conclusion: Ontological HPS

This chapter started with a rough review of some of the main approaches to the relationships between history and philosophy of science. Georges Cartwright (1983[1966]), an early champion of merging history of science and epistemology, argued that it is theories and concepts that give the sciences their specificity by constituting the scientific objects. For him, scientific objects (a linguistic-mathematical discourse about nature) are culturally informed abstractions and cuts imposed onto otherwise continuous natural objects (“the pre-texts”, he wrote). Instruments and practices may facilitate this process, but epistemologically relevant history of science should take an interest in them only inasmuch as they enable object-investing theories to be erected and dismissed. The focus on theories, moreover, permits the historian-epistemologist to describe the long-term and painstaking process of achieving greater degrees of truth, understood as correspondence between the object of science and the natural object. The problem with Canguilhem’s perspective is that it does not clarify by which mechanisms the scientific object and the natural object are reunified once they have been set as radically apart from each other as he does. It is a problem shared by so unnatural companions as Karl Popper and historians and sociologists of science who seek for ways to combine the finding of their disciplines with some sort of critical realism.

The argument I have presented here is that attention to physical tangible matter and materiality reveals the role that objects have in scientific operational constructions from the onset. Scientific theories (including here theorems, structures, the stable relationships of phenomenological laws, differential equations, classifications, models...) always include the objects in some way, or rather, signs of the objectual referentials obtained by operational transformations within historically constituted constraining frameworks. The degree to which objects and their relationships are included is what determines the degree of truth of the theory—the difference between a T/S diagram and the conveyor belt theory.

Sciences thus result from abstractions from the world of practice (Agar 2012). But these abstractions are of a particular kind: they are categorical in that they transform chunks of the world into the terms of a processual mesh of relationships given at a particular scale—as when bodies of water are reduced to samples and these in turn proxied by measures of temperature and salinity. These sets of continuities and transformations enable peculiar circular relationships between the terms of each scientific field. The stability of these fields can only be determined retrospectively. This makes important differences regarding whether we consider disciplines to be more or less provisional artifacts of our knowledge of nature or grounded in objectual rifts and thus bearing ontological import.

The attention to materiality of the so-called material turn has led to substantial revisions of the history of Ancient, early modern and modern sciences. I have reviewed some of them, for instance examples around thermodynamics. But this attention to materiality has also received varying philosophical interpretations, often contradictory to one another. Following inclusive (non-reductionist) materialisms, I propose here to avoid the temptations of hypostasizing physical matter and to embrace an inclusive idea of materiality which accepts that it comes in different levels and, so to say, formats. If forms detached from matter are the stuff of Platonists' and spiritualists' mythical hypostases, matter detached from form is not less delusional. Materiality enters the different scientific fields through series of operational transformations, for instance through observational instruments, samples, measurements, and labels. And each field is defined around one or several types of historically—constituted constraining framework which facilitates the establishment of relationships between those transformed materials. The importance of the history of science to both philosophy of science and ontology lies in its possibilities to pointing to the ways in the human perceptual and historical scales overlap with, but not exhaust, a reality independent from humans.

References

- Agar, J. 2012. *Science in the 20th Century and Beyond*. Cambridge: Polity Press.
- Alvargonzalez, D. 2013. Is the history of science essentially Whiggish? *History of Science* 51(1):85–99.

- Arabatzis, T. 2006. On the inextricability of the context of discovery and the context of justification. In *Revisiting Discovery and Justification*, eds. J. Schickore and F. Steinle, 215–230. Springer.
- Arabatzis, T. 2007. *Representing Electrons: A Biographical Approach to Theoretical Entities*. Chicago: Chicago University Press.
- Arabatzis, T. 2019. Explaining science historically. *Isis* 110(2):354–359.
- Arabatzis, T., and J. Schickore. 2012. Introduction: Ways of integrating history and philosophy of science. *Perspectives on Science* 20(4):395–408.
- Baird, D. 2004. *Thing Knowledge. A Philosophy of Scientific Instruments*. Berkeley: University of California Press.
- Barkan, D.K. 1999. *Walther Nernst and the Transition to Modern Physical Science*. Cambridge: Cambridge University Press.
- Boltzmann, L. 1974[1904]. On statistical mechanics. In *Theoretical Physics and Philosophical Problems. Vienna Circle Collection*, ed. B. McGuinness, vol. 5, 159–172. Dordrecht: Springer.
- Bridgman, P.W. 1927. *The Logic of Modern Physics*. New York: The Macmillan Company.
- Broadbent, A. 2013. *Philosophy of Epidemiology*. Palgrave MacMillan.
- Bunge, M. 1988. The ambivalent legacy of operationalism. *Philosophia Naturalis* 25:337–345.
- Bunge, M. 2003. *Emergence and Convergence: Qualitative Novelty and the Unity of Knowledge*. Toronto: University of Toronto Press.
- Bunge, M. 2010. *Matter and Mind: A Philosophical Inquiry*. New York: Springer.
- Bueno, G. 1972. *Ensayos Materialistas*. Madrid: Taurus.
- Bueno, G. 1991–1993. *La Teoría del Cierre Categorical. 5 vols*. Oviedo: Pentalfa.
- Bueno, G. 2013. *Sciences as Categorical Closures*. Oviedo: Pentalfa.
- Bueno, G. 2019. *The Happiness Delusion: Debunking the Myth of Happiness*. Oviedo: Pentalfa.
- Burt, E.A. 1924. *The Metaphysical Foundations of Modern Physical Science*. London: Kegan Paul.
- Butterfield, H. 1949. *The Origins of Modern Science, 1300–1800*. London: G. Bell.
- Camprubí, L. 2018. Experiencing deep and global currents at a ‘Prototypical Strait’, 1870s and 1980s. *Studies in History and Philosophy of Science* 70:6–17.
- Canguilhem, G. 1966[1983]. L’objet de l’histoire des sciences. In *Études d’Histoire et de Philosophie des Sciences*, ed. G. Canguilhem, 11–23. Paris: Vrin.
- Cartwright, N. 1983. *How the Laws of Physics Lie*. Oxford: Clarendon Press.
- Collins, H.M. 1992. *Changing Order. Replication and Induction in Scientific Practice*. Chicago: The University of Chicago Press.
- Comte, A. 1844. *Traité Philosophique d’Astronomie Populaire*. Paris: Carilian-Goeury et v. Dalmont.
- Cook, H. 2007. *Matters of Exchange. Commerce, Medicine, and Science in the Dutch Golden Age*. New Haven: Yale University Press.
- Coopmans, C. et al. (eds.) 2014. *Representation in Scientific Practice Revisited*. Cambridge: The MIT Press.
- Crombie, A.C. 1953. *Robert Grosseteste and the Origins of Experimental Science 1100–1700*. Oxford: Oxford University Press.
- Daston, L., and P. Galison. 2007. *Objectivity*. New York: Zone Books.
- Daston, L. 2009. Science Studies and the History of Science. *Critical Inquiry* 35:798–813.
- Daston, L., and E. Lunbeck. 2011. *Histories of Scientific Observation*. Chicago: Chicago University Press.
- Duhem, P. 1906. *La théorie physique. Son objet, sa structure*. Paris: Marcel Rivière.
- Dupré, J. 1993. *The Disorder of Things. Metaphysical Foundations of the Disunity of Science*. Cambridge: Harvard University Press.
- Dutreuil, S. 2018. James Lovelock’s gaia hypothesis: “A New Look at Life on Earth” . . . for the life and the earth sciences. In *Dreamers, Visionaries, and Revolutionaries in the Life Sciences*, eds. O. Harman and M.R. Dietrich, 272–287. Chicago: The University of Chicago Press.
- Edgerton, S. 1984. Galileo, Florentine disegno, and the ‘Strange Spottedness of the Moon’. *Art Journal* 40:225–232.

- Edwards, P. 2010. *A Vast Machine Computer Models, Climate Data, and the Politics of Global Warming*. Cambridge: The MIT Press.
- Farrington, B. 1947. *Head and Hand in Ancient Greece: Four Studies in the Social Relations of Thought*. London: Watts.
- Feest, U., and T. Sturm. 2011. What (Good) is historical epistemology? Editors' introduction. *Erkenntnis* 75:285–302.
- Ferreirós, J. 2010. The dynamics of experimentation and its role within a philosophy of scientific practices. In *New Methodological Perspectives on Observation and Experimentation in Science*, ed. W. J. González, 99–113. La Coruña: Netbiblo.
- Fleck, L. 1979[1935]. *Genesis and Development of a Scientific Fact*, eds. Thaddeus J. Trenn and Robert K. Merton; Translated by Fred Bradley and Thaddeus J. Trenn. Foreword by Thomas S. Kuhn. Chicago: The University of Chicago Press.
- Franklin, A. 1986. *The Neglect of Experiment*. Cambridge: Cambridge University Press.
- Friedman, M. 1993. Remarks on the history of science and the history of philosophy. In *World changes: Thomas Kuhn and the Nature of Science*, ed. P. Horwich, 36–54. Cambridge, MA: The MIT Press.
- Galison, P. 2003. *Einstein's Clocks, Poincare's Maps: Empire of Time*. New York: W. W. Norton & Co.
- Giere, R. 1973. History and philosophy of science: Intimate relation or marriage of convenience? *British Journal for the Philosophy of Science* 24:282–297.
- Giere, R. 2011. History and philosophy of science: Thirty-five years later. In *Integrating History and Philosophy of Science: Problems and Prospects*, eds. S. Mauskopf and T. Schmaltz, 59–66. Dordrecht: Springer.
- Gillispie, C.C. 1960. *The Edge of Objectivity. An Essay in the History of Scientific Ideas*. New Jersey: Princeton University Press.
- Gitelman, L. 2013. *Raw Data Is an Oxymoron*. Cambridge: The MIT Press.
- Goodwin, C. 1995. Seeing in depth. *Social Studies of Science* 25:237–274.
- Hacking, I. 1975. *The Emergence of Probability. A Philosophical Study of Early Ideas about Probability, Induction, and Statistical Inference*. Cambridge: Cambridge University Press.
- Hacking, I. 1983. *Representing and Intervening*. Cambridge: Cambridge University Press.
- Hacking, I. 1996. The looping effects of human kinds. In *Causal Cognition: A Multidisciplinary Debate*, eds. D. Sperber, D. Premack, and A. J. Premack. New York: Oxford University Press.
- Hacking, I. 1999. *The Social Construction of What?* Cambridge: Harvard University Press.
- Hahn, H., O. Neurath, and R. Carnap. 1973[1929]. The scientific conception of the world. In *Empiricism and Sociology*, eds. M. Neurath and R. Cohen, 299–318. Dordrecht: Reidel P. C.
- Hamblin, J.D. 2014. Seeing the oceans in the shadow of Bergen values. *Isis* 105(2):352–363.
- Hanson, N.R. 1958. *Patterns of Discovery*. Cambridge: Cambridge University Press.
- Hanson, N.R. 1962. The irrelevance of history of science to philosophy of science. *Journal of Philosophy* 59:574–586.
- Harkness, D.E. 2007. *The Jewel House: Elizabethian London and the Scientific Revolution*. New Haven: Yale University Press.
- Harman, G. 2009. *Prince of Networks. Bruno Latour and Metaphysics*. Melbourne: Re-Press.
- Hatfield, G. 1996. Review: The importance of the history of science for philosophy in general. *Synthese* 106(1):113–138.
- Hecht, G. 2018. Interscalar vehicles for an African anthropocene: On waste, temporality, and violence. *Cultural Anthropology* 33(1):109–141.
- Helmholtz, H. 1995[1847]. On the conservation of force. In *Science and Culture: Popular and Philosophical Essays*, ed. David Cahan, 96–126. Chicago: Chicago University Press.
- Hempel, C.G. 1952. Fundamentals of concept formation in empirical science. In *Foundations of the Unity of Science*, eds. O. Neurath, R. Carnap, C. Morris, vol. 2, 651–746. Chicago: University of Chicago Press.
- Helmreich, S. 2019. Reading a wave buoy. *Science, Technology & Human Values* 44(5):737–761.
- Hessen, B. 1931. The social and economic roots of Newton's Principia. In *Science at the Crossroads*, ed. N.I. Bukharin. London.

- Huerga, P. 1999. *La Ciencia en la Encrucijada*. Oviedo: Pentalfa.
- Husserl, E. 1962[1936]. *L'Origine de la Géométrie*. Trans. J. Derrida. Paris: Presses Universitaires de France.
- Ihde, D. 1990. *Technology and the Lifeworld. From Garden to Earth*. Bloomington: Indiana University Press.
- Ingold, T. 2011. *Redrawing Anthropology: Materials, Movements, Lines*. Aldershot: Ashgate.
- Kline, R. 1995. Construing "Technology" as "Applied Science": Public rhetoric of scientists and engineers in the United States, 1880–1945. *Isis* 86:194–221.
- Koyré, A. 1939. *Études Galiléennes. 3 vols.* Paris: Hermann.
- Kuhn, T.S. 1962. *The Structure of Scientific Revolutions*. Chicago: University of Chicago Press.
- Kuhn, T.S. 1977. Energy conservation as an example of simultaneous discovery. In *The Essential Tension: Selected Studies in Scientific Tradition and Change*, ed. T.S. Kuhn, 66–104. Chicago: Chicago University Press.
- Latour, B. 1999. *Pandora's Hope. Essays on the Reality of Science Studies*, 145–173. Cambridge, MA: Harvard University Press.
- Latour, B. 2000. On the partial existence of existing and nonexisting objects. In *Biographies of Scientific Objects*, ed. L. Daston. Chicago: The University of Chicago Press.
- Latour, B. 2007. Can we get our materialism back, please? *Isis* 98(1):138–142.
- Latour, B. 2019. *Down to Earth. Politics in the New Climatic Regime*. Cambridge, MA: Polity.
- Laudan, L. 1989. Thoughts on HPS: 20 years later. *Studies in History and Philosophy of Science* 20:9–13.
- Long, P.O. 2011. *Artisan/Practitioners and the Rise of the New Sciences, 1400–1600*. Corvallis: Oregon State University Press.
- Mach, E. 1919[1883]. *The Science of Mechanics. A Critical and Historical Account of Its Development*. Chicago: The Open Court Publishing.
- Manders, K. 2008. Diagram-based geometric practice. In *Visualization, Explanation and Reasoning Styles in Mathematics*, eds. P. Mancosu et al., 65–79. The Netherlands: Springer.
- Malafouris, L. 2013. *How Things Shape the Mind*. Cambridge: The MIT Press.
- McMullin, E. 1976. History and philosophy of science – a marriage of convenience? In *PSA 1974, Boston Studies in the Philosophy of Science*, eds. R.S. Cohen et al., vol. 32, 585–601. Dordrecht: Reidel.
- Meli, D.B. 2006. *Thinking with Objects. The Transformation of Mechanics in the Seventeenth Century*. Baltimore: John Hopkins University Press.
- Netz, R. 1999. *The Shaping of Deduction in Greek Mathematics. A Study in Cognitive History*. Cambridge: Cambridge University Press.
- Newman, W. 2006. *Atoms and Alchemy. Chymistry and the Experimental Origins of the Scientific Revolution*. Chicago: The University of Chicago Press.
- Ongay, I. 2016. La filosofía de Ernst Mach desde el materialismo filosófico. *El Basilisco* 46:39–49.
- Osler, M.J. 2010. *Reconfiguring the World: Nature, God, and Human Understanding from the Middle Ages to Early Modern Europe*. Baltimore: John Hopkins University Press.
- O'Connell, J. 1993. The creation of universality by the circulation of particulars. *Social Studies of Science* 23(1):129–173.
- Parrilla, G. et al. 1994. Rising temperatures in the subtropical North Atlantic Ocean over the past 35 years. *Nature* 369(5 May):48–51.
- Pickering, A. 1995. *The Mangle of Practice. Time, Agency, and Science*. Chicago: The University of Chicago Press.
- Popper, K. 1959[1935]. *The Logic of Scientific Discovery*. London: Hutchinson.
- Porter, T. 1986. *The Rise of Statistical Thinking, 1820–1900*. New Jersey: Princeton University Press.
- Quine, W.V.O. 1951. Two dogmas of empiricism. *The Philosophical Review* 60(1):20–43.
- Rheinberger, H.J. 2005. Gaston Bachelard and the notion of "Phenomenotechnique". *Perspectives on Science* 13(3):313–328.
- Rheinberger, H.J. 2010a. *On Historicizing Epistemology: An Essay*. Stanford: Stanford University Press.

- Rheinberger, H.J. 2010b. On the historicity of scientific knowledge: Ludwik Fleck, Gaston Bachelard, Edmund Husserl. In *Science and the Life-World. Essays on Husserl's 'Crisis of European Sciences'*, eds. D. Hyder and H. J. Rheinberger, 164–176. Stanford: Stanford University Press.
- Rheinberger, H.J. 2010c. *An Epistemology of the Concrete. Twentieth-Century Histories of Life*. Durham: Duke University Press.
- Roberts, L. 2018. *Compound Histories: Materials, Governance and Production, 1760–1840*. Brill.
- Roberts, L., P. Dear, and S. Schaffer. 2007. *The Mindful Hand: Inquiry and Invention from the Late Renaissance to Early Industrialisation*. Chicago: The University of Chicago Press.
- Roemmich et al. 2019. Deep SOLO: A full-depth profiling float for the argo program. *American Meteorological Society* 36:1967–1981.
- Romero, G.E. 2020. *La Naturaleza del Tiempo*. Navarra: Txalaparta.
- Rowlands, M. 2005. A materialist approach to materiality. In *Materiality*, ed. D. Miller, 72–87. London: Duke University Press.
- Schaffer, S. 1989. Glass Works: Newton's prisms and the uses of experiment. In *The Uses of Experiment*, ed. D. Gooding, T.J. Pinch, and S. Schaffer. Cambridge: Cambridge University Press.
- Seth, S. 2010. *Crafting the Quantum. Arnold Sommerfeld and the Practice of Theory, 1890–1926*. Cambridge: The MIT Press.
- Shapere, D. 1977. What can the theory of knowledge learn from the history of knowledge? *The Monist* 60:488–508.
- Shapin, S. 1994. *A Social History of Truth. Civility and Science in Seventeenth-Century England*. Chicago: The University of Chicago Press.
- Shapin, S., and S. Schaffer. 1985. *Leviathan and the Air-Pump, Hobbes, Boyle, and the Experimental Life*. New Jersey: Princeton University Press.
- Smith, C. 1998. *The Science of Energy: A Cultural History of Energy Physics in Victorian Britain*. Chicago: University of Chicago Press.
- Smith, C., and N. Wise. 1989. *Energy and Empire: A Biographical Study of Lord Kelvin*. Cambridge: Cambridge University Press.
- Smith, P.H. 2004. *The Body of the Artisan: Art and Experience in the Scientific Revolution*. Chicago: The University of Chicago Press.
- Smith, P.H., and P. Findlen. (eds.) 2002. *Merchants and Marvels. Commerce, Science, and Art in Early Modern Europe*. New York: Routledge.
- Sturm, T. 2014. Michael Friedman and the “Marriage” of history and philosophy of science. *Metascience* 23(2):225–232.
- Suárez, M. 2019. *Filosofía de la Ciencia*. Madrid: Tecnos.
- Tilley, C. 2004. *The Materiality of Stone*. Oxford: Berg.
- Werrett, S. 2019. *Thrifty Science: Making the Most of Materials in the History of Experiment*. Chicago: The University of Chicago Press.
- Wise, M.N. 1989–1990. Work and waste: Political economy and natural philosophy in nineteenth century Britain. *History of Science* 27:263–301 and 28:221–261.
- Wise, M.N. 1992. Mediations: Enlightenment balancing acts, or the technologies of rationalism. In *World Changes: Thomas Kuhn and the Nature of Science*, ed. P. Horwich, 207–256. Cambridge: Cambridge University Press.
- Wise, M.N. 2011. Science as (historical) narrative. *Erkenntnis* 75:349–376.
- Wunsch, C. 1992. Decade-to-century changes in the ocean circulation. *Oceanography* 5(2):99–106.

Chapter 9

Materialism, Logic, and Mathematics



Carlos M. Madrid Casado

The very life of mathematical thinking consists in making experiments upon diagrams and the like and in observing the results.

Charles S. Peirce, New Elements of Geometry (1894).

You could say arithmetic is a kind of geometry; i.e. what in geometry are constructions on paper, in arithmetic are calculations (on paper). You could say, it is a more general kind of geometry.

L. Wittgenstein, Philosophical Remarks §109 (1929–1930).

Abstract In the last half century, several philosophies of mathematics situate themselves in the orbit of materialism. However, their divergences are as important as their commonalities. Some examples include Mario Bunge’s systemic emergentism, Philip Kitcher’s naturalized empiricism, Eric Livingston’s ethnomethodology, the physicalist account of mathematics, the philosophy of mathematical practice, and the cognitive-anthropological approaches of Reviel Netz and Ian Hacking. These philosophies share common arguments, such as the denial of ontological Platonism and the partial or total refutation of the traditional aprioristic epistemology of mathematics. However, only a handful of these materialist approaches emphasize the constitutive role played by the corporeity of mathematicians and the materiality of logical and mathematical “ideograms” (to use the semiotic concept coined independently by Javier de Lorenzo and Brian Rotman). Following Gustavo Bueno’s formalist materialism, this chapter explores how a reconsideration of the role of mathematical *glyphs*—in Greek geometry, topology, and modern algebra, among other—blurs the boundary between the formal sciences and the natural or empirical sciences. There are no *formal* sciences, no sciences engaging in the study of pure and immaterial forms (be they logical or mathematical). The so-called formal

C. M. Madrid Casado (✉)
Fundación Gustavo Bueno, Asturias, Spain
e-mail: cmadrid@fgbueno.es

© Springer Nature Switzerland AG 2022
G. E. Romero et al. (eds.), *Contemporary Materialism: Its Ontology and Epistemology*, Synthese Library 447,
https://doi.org/10.1007/978-3-030-89488-7_9

269

sciences are, in fact, *material* sciences, because their construction requires scientists to perform operations with physical objects, such as signs and corporeal lines and circles. Logic thus emerges as a particular kind of mathematics dealing with glyphs that operate in a *self-forming* way. To end, the chapter offers an alternative (materialist) explanation of the “miracle” of the effectiveness of mathematics in the world.

9.1 Brief History of the Philosophy of Mathematics

The persistence of the philosophy of mathematics is due to two singular facts that require explanation: the adamant nature of mathematical proofs and the inexhaustible richness of the applications of mathematics in the natural world (Hacking 2014). The first fact raises a raft of questions: What is the foundation of mathematics? What are numbers, geometric shapes, or sets? What is mathematical truth? The second inexorably raises the question of the unreasonable effectiveness of mathematics.

Like logic, mathematics seems to differ greatly from the rest of the natural and social sciences. The objects of the formal sciences are not located in space–time, the related research methods are deductive rather than inductive, and the status of logical and mathematical knowledge is solid, immovable, and infallible, unlike the knowledge provided by the empirical sciences.

The problem with all these epistemological and ontological questions is that they have not had and do not have a single answer, but many. Those given by, *inter alia*, Plato, Descartes, and Kant join with those put forth by the four classical schools on the foundations of mathematics (Platonism, logicism, formalism, and intuitionism) in the first third of the twentieth century, whose origin must be pinpointed in the tensions between different ways of doing mathematics throughout the nineteenth century.

After World War II, the division between mathematicians and philosophers in relation to mathematics grew ever more acute. While mathematicians had been the protagonists until then, philosophers by trade soon began to gain greater stature. The classical positions held by Frege, Russell, Hilbert, and Brouwer continued to be the subject of debate, with the emergence of Frege-influenced neologicists (Crispin Wright and George Boolos), formalists who conceived of mathematics as the science of formal systems (Haskell B. Curry), and constructivists of varying slants (from intuitionists such as Dirk van Dalen to numerical constructivists such as Errett Bishop and predicativists such as Solomon Feferman). Platonism even continued in the discussions on the indispensability arguments presented by Quine and Putnam.

Most of the works in this period were technical papers on logic and set theory. Works taking a more philosophical approach, *i.e.* dealing more concerned with the epistemology and ontology of mathematics than with a reduction thereof to logic or set theory, did not come about until two papers by Paul Benacerraf.

Benacerraf (1965) showed that there are multiple set-theoretic ways of defining natural numbers. Using Zermelo ordinals, the number 2 can be identified with $\{\{\emptyset\}\}$ but also, using Von Neumann ordinals, with $\{\emptyset, \{\emptyset\}\}$. This set-theoretic polymorphism paved the way for structuralism, where the number 2 is not an object endowed with internal properties but rather an element inserted in a structure—natural numbers—that can be instantiated in different isomorphic ways (Parsons 1990; Shapiro 1997; Resnik 1997).

Benacerraf (1973) posed a famous dilemma: if mathematical propositions are true and truth demands reference, one must invoke the existence of the abstract entities to which they refer and which—given the necessity with which mathematical theorems are deduced—cannot belong to the empirical world, which is always contingent. However, if the mathematical entities transcend the world around us, we cannot know them, because we cannot causally interact with them. What seems necessary for mathematical truth itself precludes the knowledge of such truth, and what would make mathematical knowledge possible precludes the truth thereof.

Analytic philosophers split into those who held onto the ontological rein of Benacerraf's dilemma and those who preferred the epistemological rein. The former rejected the existence of abstract entities disconnected causally and embraced a mathematical nominalism that conceives of mathematical objects as fictions, such that numbers, points, and sets have the same status as Sherlock Holmes and Don Quixote (hence the fictionalism of Harry Field 1980, 1989). Accepting the existence of abstract entities, the latter broke with the causal theory of knowledge inspiring the formulation of the dilemma and proposed that mathematical objects were known through processes of intuition different from the processes of knowledge linked to the senses (hence the renewed Platonism of Penelope Maddy 1990).

The problem with the analytic philosophy of mathematics is that, in general, it set the genetic and historical aspects of mathematics to the side. For example, in *Philosophy of Mathematics in the Twentieth Century* Charles Parsons (2014) holds that he engages in a philosophy proper to the English-speaking world and dispatches the French tradition—in which history is more prominent than logic—by saying that this tradition is little known.¹ In addition, the analytic philosophy of mathematics tends to excessively formalize, often taking the form for the content in relation to the mathematical *factum*.

While the reflections on the crisis of foundations that occurred around 1900 were led by mathematicians and the distance between the problems dealt with and the practice of mathematics was nearly nonexistent, as from the middle of the twentieth century this distance has grown, despite the contributions of Pólya (1945), Lakatos (1976), Davis and Hersh (2012[1981]), and historians such as Michael Crowe, Joseph Dauben, and Ivor Grattan-Guinness, who have added sophisticated nuance to the historiography of mathematics by connecting internal

¹ Parsons (2014, 8 f. 10).

and external factors (Crowe 1988). Until practically the end of the twentieth century, the philosophy of mathematics was identified with the foundations of mathematics, i.e. with a specialty related to logic and set theory. The dominant Anglo–American tradition has been systematic albeit ahistorical, with a few exceptions; the minority continental tradition has been closer to history but also more dispersed.²

The only way to avoid this impasse is to engage in a philosophy actually focused on the practice of mathematics through an approach that takes history and, in general, the anthropology of mathematics into account. Philip Kitcher (1983), Corfield (2003), and especially the contributions by Hersh (2006), Ferreirós and Gray (2006), and Mancosu (2008) stand out in this shift, along with the possibility of returning to reflections first made by certain mathematicians by trade (such as Poincaré, Hadamard, Gian-Carlo Rota, and René Thom) and then by certain philosophers from outside the Anglo–Saxon world who have for years been thinking about mathematics as an activity (such as Javier de Lorenzo and Gustavo Bueno). It is at this juncture where, in my view, a materialist philosophy of mathematics can gain strength, one which definitively overcomes the assertion made by Bunge (1985, 17): “None of the well-known philosophies of mathematics is a component of a philosophical system consonant with contemporary mathematics and factual science.”

9.2 Materialist Philosophies of Mathematics

Whether looking back at the philosophies concerned with the foundations of mathematics (the foundational approaches) or at the philosophies more attentive to the practice of mathematics that have emerged in recent times (the historical or naturalist approaches), there is a plurality of philosophies of mathematics that gravitate within materialism’s orbit, although they do not all understand materialism in the same manner.³ In general, most materialist philosophies of mathematics move between two extremes, simplified as follows: (i) those that locate the essence of mathematics in being a system of graphical inscriptions (\approx mathematical physicalism) and (ii) those that locate this essence in being a system of conceptual artifacts (\approx mathematical fictionalism). While the first group of theories present

² As is evident, this overview of the philosophy of mathematics is not exhaustive. There are more currents that are not mentioned, such as the phenomenological approach initiated with Edmund Husserl and developed further by several followers (Hartimo 2010).

³ For certain authors, the real and the material are defined by changeability and having energy (Bunge 2006, Romero 2018). For others, matter is defined as being a plurality of parts linked in some manner but also discontinuous, such that not all parts are connected with the all the others (Bueno 1972 and 2016). While the first definition is more attached to science and, in particular, to physics, the second seems closer to the philosophical tradition, since matter is opposed to spirit, which is defined by simplicity and harmony.

themselves as materialist for obvious reasons, the theories of the second group do so fundamentally as a result of their opposition to Platonism. In further detail:

1. At the first extreme is the inscriptionist formalism defended by the mathematicians Heinrich Eduard Heine and Johannes Thomae at the University of Halle at the end of the nineteenth century. For Heine (1872, 173), “what I call numbers are certain tangible signs,” with Thomae (1898, 3) holding that “arithmetic is a game with signs.” Both mathematicians are remembered today as being the focus of Frege’s critique, who accused them of ignorantly confusing numerals with numbers. Were numbers not concepts but rather signs, an infinitely large blackboard would be necessary to produce an infinite series.

The idea that mathematics is, in essence, a system of inscriptions, of marks included on the margins of paper or a blackboard, is not foreign to Hilbertian formalism, but reaches its maximum expression with physicalism (Irvine 1990). For Szabó (2003), there are only marks on paper, without further meaning, that we manipulate following certain rules, nothing more. Another variant of physicalism is the finite constructivism put forward by the mathematician N.J. Wildberger (2005), for whom only physically constructible numbers exist, which leads him deny the existence of irrational numbers and infinite sets.

The problem with physicalism is that, apart from its mutilation of the richness of mathematics, it fails to do justice to mathematical practice as a human activity. Physicalism places great emphasis on logical and algebraic signs, but completely forgets geometric glyphs, mathematicians themselves, and their concepts, thereby reducing all branches of mathematics to a collection of formal systems.

2. At the second extreme are materialist philosophers who defend that mathematics is a system of concepts. A prototype of this position is Mario Bunge’s systemic materialism.

For Bunge (1985, 2006), formal sciences are distinguished from the other sciences because their universe of discourse only contains concepts (there are no facts or things). Logical and mathematical concepts, though, do not inhabit the realm of Platonic ideas; they are nonarbitrary constructs (because they follow certain formal rules) of the human brain. Reversing the Platonic metaphor, Bunge contends that mathematical ideas are the shadow of real things, and shadows do not exist autonomously. However, Bunge insists that mathematical concepts are impersonal, universal, and necessary.

Bunge’s mathematical philosophy rests on the distinction between the formal and the factual as inherited from logical empiricism (Marquis 2012). In this line, he defends the a priori and purely conceptual character of mathematics, even while admitting that mathematical activity can involve something more than deduction, such as induction, abstraction, generalization, trial and error, analogy, etc. However, he holds that mathematics has been separated from its empirical origins for millennia.

On this basis, Bunge counters Platonism to say that mathematical objects are conceptual fictions lacking any empirical content.⁴ At heart, numbers and geometric figures have the same pedigree as literary creations, but Bunge (2006, 198) makes it clear that the presence of certain formal laws prevents mathematics from becoming a mere game of conventions: “Mathematics is a gigantic (though not arbitrary) fiction.” It is the position that Bunge calls *fictionism* (perhaps to distinguish it from Hartry Field’s less moderate *fictionalism*).⁵

From the fictionist point of view, the notion of truth plays a peripheral role in mathematics, one limited to logical derivation within a formal system. For Bunge, a mathematical construct exists if there is a set, class, or category that contains it and if it can be specified by means of a consistent formal theory. Mathematical logic is the substratum and language of all mathematics. However, as Marquis (2012) critiques, in this Bunge again assumes the foundational approach, i.e. that all mathematics can be reduced to set theory or category theory (which is, more than a reality, a *desideratum*).⁶

To my mind, Bunge neglects the historical dimension of mathematical constructs and falls into the anachronism of projecting the view of doing mathematics inherent to the second half of the twentieth century to the entire discipline. Mathematically, it is not only the formalized that exists. Were this so, the concept of an integral would only exist mathematically as from the nineteenth-century treatises of analysis, which in Cauchy’s wake used limits to redefine the notion inherited from Newton and Leibniz. As pointed out by Davis and Hersh (2012, 392), this is the mistake “of identifying mathematics itself (what real mathematicians really do in real life) with its mode of representation in methamathematics, or, if you prefer, first-order logic.”

This vision of mathematics as a pure conceptual system is difficult to reconcile with mathematical praxis. Bunge notes that drawn triangles do not belong to mathematical geometry.⁷ Yet, it is a fact that mathematical knowledge is continuously reified by writing signs or drawing figures on paper or the blackboard. For Bunge, although geometry starts with diagrams, it is a fallacy to confuse those diagrams with the concepts they represent, for if geometry were an empirical

⁴ To avoid the literary overtones of the word “fiction,” Romero (2018) speaks of conceptual artifacts. Otávio Bueno (2009) speaks of abstract artifacts.

⁵ In what follows I will use the generic label *fictionalism* to encompass all modalities of mathematical fictionalism and will only use the label *fictionism* to refer to Bunge’s fictionalism. It should be clarified that, apart from the materialist fictionalism of Mario Bunge and Gustavo Romero, there are modalities of nonmaterialist fictionalism in mathematics, such as the fictionalism advocated by Otávio Bueno (2009), who does not declare himself an *atheist* but an *agnostic* in relation to the existence of abstract mathematical objects.

⁶ For Romero (2018), who also advocates for materialist fictionalism, logic is a pure, formal syntax, while mathematics is interpreted and has a semantics that makes reference to its conceptual artifacts. Accordingly, he holds that the foundational approach lacks a sound footing.

⁷ Bunge (1985, 12).

science, it would have to be proven empirically.⁸ As I will argue throughout the chapter, though, it is in a way like this, because mathematical proofs are always written and no mathematician could accept a mental, nonwritten proof.

For him as a fictionalist philosopher of mathematics, mathematical signs and diagrams are something secondary, a mere pedagogical support, which does not do justice to the importance of notation in mathematics: two, II, and 2 mean the same thing, but the Indo–Arabic number presents a computational power lacking in the word or Roman numeral. As Marquis (2012, 1573) puts it, “one has to be careful not to throw away the baby with the bath water: I, for one, believe that no matter what we say about mathematical knowledge, its symbolic aspects have to be invoked and explained.”

Between the physicalist and fictionalist extremes are more philosophies of mathematics close to materialism, such as naturalized empiricism in Kitcher (1983), ethnomethodology in Livingston (1986), and other positions to be discussed below.⁹ Following this panoramic overview, it can be seen that materialism takes shape in mathematics in myriad ways. On one hand, there is the vulgar materialism of physicalism. On the other hand, there is a fictionalism bordering on idealism, because—as Bunge (1997, 67) himself acknowledges—“as far as mathematical fictionalism is concerned, one may hold the world either to be material, or to be spiritual.”

It is therefore debatable that there are common lines that allow us to speak of a shared materialist vision of the formal sciences. For instance, what does the fictionalist view of mathematics in Mario Bunge’s emergent materialism have to do with De Freitas and Sinclair (2014) “inclusive materialist philosophy of mathematics,” which points to the materiality of mathematical objects and the fact that they are constructed as a result of a reasoning where concepts, gestures, sounds, and diagrams interpenetrate one another? The answer is that they share very little except for the critique of mathematical Platonism, of the original philosophy of mathematics, which continues to be the religion exercised in private by most mathematicians, since they tend to abstract mathematics from space and time, from the physical and the mental. Perhaps the only argument common to all materialist philosophies of mathematics is precisely the critique of the ontological fundamentalism that bases doing mathematics on the prior existence of ideal objects the knowledge of which the mathematician would gain through Platonic intuition. All materialist philosophies of mathematics are characterized by denying the existence of abstract entities with properties and relations that would exist even if the human species had never existed.

⁸ Bunge (1985, 118).

⁹ Among them is the historical-cognitive approach taken by Netz (1999), who does not define himself as materialist, but whose materialism Latour (2008, 444) is sure of.

Although not shared by all materialist philosophies, another widespread argument is the total or partial refutation of the traditional apriorist epistemology of mathematics, accepting the presence of quasi-empirical methods in mathematical praxis, as well as the historicity of mathematical knowledge. If mathematics is a human creation, then it is fallible. There are errors of calculation (i.e. an incorrect use of certain rules), false conjectures (such as the one that led Ampère in 1806 to prove that a continuous function at all points is derivable), and perfectible conceptions (such as the notion of manifold or, nowadays, the notion of fractal set). Concepts, methods, and notations are not precisely delimited as from their construction. Moreover, the standards of rigor are fickle, such that what was accepted yesterday as an act of faith must be proved today (as shown by the avatars of the fundamental theorems of nineteenth-century analysis). From this emerges a tentative, fallible, and evolutionary vision of mathematical knowledge and a conception of mathematical praxis as something living, something ongoing.

However, only a few materialist approaches stress the constitutive role of the corporeality of mathematicians and the materiality of mathematical glyphs. The gnoseological question “what is mathematics?” can be understood as a question of how mathematicians made of flesh and blood can organize signs, graphs, paper, blackboards, rulers, compasses, Platonic or Archimedean solid models, calculators, computers, articles, books, propositions, theorems, and corollaries as mathematical *materials* such that geometry, algebra, and analysis are determined to have a scientific body of their own that differentiates them from other sciences.

It is not a question of reducing mathematics to a system of inscriptions or of reducing it to a separate system of concepts. It is a matter of coordinating the two planes while preserving the primacy of the material plane: the mathematician always operates with corporeal signs, lines, and circles, although a straight line or circumference, as structures, are not reduced to either lines or circles or to mental contents.

Amid the materialist philosophies of mathematics are several currents attentive to the corporeal manipulation of logical and mathematical glyphs. In what follows, I will follow Gustavo Bueno’s formalist materialism (1979a, 1979b), which can at multiple points be coordinated with the positions held by Javier De Lorenzo (1994), Brian Rotman (1997), James Robert Brown (1999), Ken Manders (1995), Reviel Netz (1999), Bruno Latour (2008), and Ian Hacking (2009). From these tenets, I will explore how reconsidering mathematical glyphs, from Greek geometry to topology and modern algebra, produces a new materialist conception of mathematics and blurs the border between formal sciences and natural or empirical sciences. In my view, the potency of this approach lies in the fact that it does not abandon philosophy to fully immerse itself in history or in the cognitive sciences, since it does not disdain ontological commitments. While certain epistemological issues have been properly addressed by Anglo-Saxon philosophers and historians that cannot be labelled as materialists, certain ontological issues relating to glyphs and mathematical practice have been systematically neglected by analytic philosophy. The challenge is to offer a materialist, nonidealist analysis of such issues.

9.3 What Is Formalist Materialism?

Apropos in this regard is a rereading of the crisis in the foundations of mathematics that took place between the nineteenth and twentieth centuries. At the time, mathematics was in the midst of an veritable golden age with splendid developments (topology, measurement theory, functional analysis, etc.), such that there was no threat of collapse and the misnomer “foundational crisis” rather concealed a crisis of methods, where the classical definitions and constructive proofs were being cornered by the new axiomatic definitions (implicit definitions) and existential proofs (through the *reductio ad absurdum*) (Bueno 1979a; De Lorenzo 1998). Large-scale attempts to lay the foundation of mathematics—logicism, formalism, intuitionism—arose when mathematicians moved from studying figures, functions, and particular equations to studying sets or classes of these constructs, which was a source of logical paradoxes and set-theoretic antinomies.

The debate on the foundations ended with the Pyrrhic victory of formalism. Despite the lethal blow that Gödel’s theorems inflicted on Hilbert’s program, the formalist idea that for a mathematical object to exist it is enough that it does not generate contradiction ended up being imposed in the face of the restrictions posed by Brouwer’s intuitionist constructivism (Madrid Casado 2014, 2018a). However, the formalist position does not fit in with the mathematician’s daily work.

For the strict formalist, every mathematical theory is summarized in a combination of signs, themselves organized within an axiomatic system. Yet if we look at any mathematician in action, we’ll be amazed at the amount of nonformal reasoning he performs on paper or on the blackboard: “Informal mathematics *is* mathematic” (Davis and Hersh 2012, 387). Mathematical proofs are often semiformal, contain arguments that combine natural language with calculations and diagrams, and do not usually take the shape of a syntactic derivation from the axioms of a formal system. In fact, the axioms of real numbers, such as those of set theory or logic, have been obtained from the analysis of informal proofs. As Poincaré noted, the genetic method precedes the axiomatic method.¹⁰ Putting the operative reality of mathematics before the axiomatic ideal shows that rigor is a final product.

Opposing formalism’s theory of semantic disconnection whereby formulas are empty formulas and meaningful only by virtue of their internal interplay within the axiomatic system, “formalist materialism recognizes signs as material content, namely, the very entity of their *signifiers* and the entire geometric structure (arrangements, permutations to the right and left, etc.) which must be implied in its own reality of signifiers” (Bueno 1979a, 29). In other words, “formalism’s semantic disconnection should not be understood as an emptying of all interpretation, but as the emptying of all interpretation not contained in the very *exercise* of the signifiers” (Bueno 1979a, 29). Logical and mathematical signs are self-referential signs so

¹⁰ In Poincaré’s harsh critique (1902a) of Hilbert’s 1899 *Foundations of Geometry*, the French geometrician insisted that the German mathematician had Euclid’s geometry in mind, even if he denied it, and limited himself to reorganizing its elements in a concealed manner.

to speak, in the sense that any reference that cannot be formulated on the plane of a sheet of paper or a blackboard is irrelevant when proving a theorem. Other disciplines also operate with signs (such as chemistry when formulating), but only logic and mathematics do so immanently, with ends that do not extend beyond the plane of their operative manipulation. Chemical symbols are not self-referential signs, because, for example, the symbol *Fe* refers to the chemical element *iron*, which can be found in rock samples, meteorites, etc. In the same way, the physical symbol *v* refers to the *velocity* of an object, i.e. to something that extends beyond the plane of the paper or blackboard on which it is inscribed. On the contrary, the sign *p* in formal logic or the sign *x* in mathematics refers to the successive mentions of its signifier in the context of a logical deduction or equation solution. The reference is immanent only in logical and mathematical signs.

From the point of view of semiotics, logical and mathematical signs consist of three components, within the semiotic triangle: signifier, signified, and referent. The signifier is the typographical mark. The signified is the concept associated with that signifier. However, it is not easy to identify the third vertex of the semiotic triangle, the referent. Idealist philosophers of mathematics locate it in the Platonic idea. Materialist philosophers of mathematics who embrace fictionalism locate it in the concept. Thus, Romero (2018, 96) holds, “Mathematics consists of a collection of formal systems which have as reference class pure conceptual objects” (although other fictionalists note that the reference class of mathematical signs is empty, since there are no abstract objects). Following the tenets of formalist materialism, I point to the signifiers themselves as the referent of logical and mathematical signs (they are thus self-referential signs).

However, this does not move back into inscriptionism, for formalist materialism does not dispense—as strict formalists did and inscriptionists do—with the signified, i.e. with the concept attached to each sign, which is one of the three necessary semiotic components. It is a question of coordinating the typographical and conceptual planes (not of only attending to the signs), while preserving the primacy of the plane of typographical materiality, which is—as I will argue in detail in Sect. 9.5 when introducing the notion of *ideogram*—the starting point of mathematics.

To my understanding, materializing the reference of the logical and mathematical signs enables us to explain the importance of symbolic aspects in mathematical knowledge. The signified of mathematical signs arises in a pragmatic context linked to the referent-signifier, to its manipulation, and to the relations that this signifier sets up with others through a mathematician’s operations. Accordingly, as I will argue in Sect. 9.4, the signified of mathematical signs (i.e. mathematical concepts) is grasped solely by doing mathematics, by manipulating signifiers. The concept-signified is formed in the context of a mathematician’s operations. As such, one cannot teach

mathematics without doing mathematics, because the concept-signified comprises an operative moment of the referent-signifier.¹¹

From the perspective of formalist materialism, the question of the connection between mathematical signifiers and mathematical concepts is a poorly formulated question; it seems to presuppose that there are, on the one hand, signifiers with no signified (a formless matter) and, on the other hand, pure concepts (an immaterial form) that are separate and must be linked later. In my view, there are no mathematical concepts separated from mathematical signifiers (i.e. lacking a symbolic counterpart) or vice versa, since the signified of any mathematical sign arises through the circuit of signifiers. As regards conceptual and typographical dimensions, mathematical signs behave like the monomial xy : if any one of its factors is annulled, then so too is the product. Thus, under this perspective, natural numbers cannot be identified with a prior conceptual structure that would later have been instantiated as I, II, III, etc. (in Roman notation) or as 1, 2, 3, etc. (in Indo–Arabic notation). The conceptual structure of natural numbers was constructed as multiple notations, as diverse collections of glyphs accompanied by their rules of manipulation were identified among themselves (even if each of these collections of signifiers had a certain conceptual structure, however obscure and confusing).

Similarly, behind the straight line and the circumference in Greek geometry lie the ruler and the compass, two instruments fashioned by craftsmen (surveyors, builders, sculptors, etc.). From the treatment with those drawn circle figures, the concept of circle was constructed (when one considers the class of all circles based on their various centers and radii). Yet, with the concept of circle we are only able to operate by means of signifiers, i.e. only by means of a corporeal circle (in the framework of Greek geometry) or its corresponding algebraic formula (in the framework of metric geometry) can we operate with circles. Lacking the sensible incarnation provided by the signifier, the concept-signified is empty. Reciprocally, without the concept-signified, the agency of the signifier is blind. The difficulty lies in the fact that the dialectic that endows the signifier with the signified and the concept with the signifier can only be elucidated historically by analyzing the operations carried out by mathematicians in specific cases.¹²

¹¹ This interweave of signifieds and signifiers in mathematics was recognized by Charles S. Peirce (2010, 83), for whom both geometric diagrams and algebraic equations were icons exhibiting the relation that the mathematician seeks to study. For example, the arrangement of an algebraic equation exhibits the relation between the quantities involved.

¹² This operative conception brings mathematics closer to other practices, such as artistic practices, because the presence of manual operations is a generic characteristic. The specificity of mathematical operations lies in the materials that are handled and in how they are handled: the mathematician manipulates signs following certain techniques (unlike the painter, he does not manipulate brushes or pigments). The operated matter is different. In addition to Sect. 9.5 of this chapter, further examples of how mathematical concepts are formed in the manipulation of mathematical glyphs can be found in the discussion at the end of the book. A simple example is provided by the definition of $0!$, an initially meaningless expression to which algebraic manipulation lends meaning. For any natural number, $n! = n \cdot (n - 1)!$, from which it follows that $(n - 1)! = n! / n$. Substituting n for

However, counter to formalist materialism, it could be argued that there are mathematical concepts so abstract that they cannot be represented by typographical signs or concepts whose meaning cannot be extracted from the arrangement of the ink or chalk marks that (in principle) constitute mathematical terms. And yet, even pure mathematics, whose concepts are the most abstract (Hilbert spaces, Lie algebra, Borsuk's theory of shape, etc.), is done by writing it and, in fact, it is often the most rigorously written and formalized mathematics. This does not imply a departure from signs or a metamorphosis of mathematics into some purely conceptual mental science that disregards signifiers. All mathematical theorems ultimately depend on signs, and no mathematician would validate a proof based on intuitive, unwritten inspection.

However, it could be counterargued that a four-dimensional object or a space of infinite dimension is not reducible to typographical signs. The appeal to abstract concepts or Platonic ideas to explain the genesis of these mathematical entities seeks to explain the obscure by resorting to even greater obscurity. Typographical signs remain the bricks with which these mathematical objects are constructed. The Klein bottle does not refer to a concept or an idea in our brain or in a Platonic heaven, one whose characteristics a mathematician would seek to describe in the way that the explorer describes the new lands she is discovering. This is impossible, because the four-dimensional Klein surface is unimaginable. No one can visualize it in their head, and artistic depictions often made of it are misleading (by self-intersecting it). The Klein bottle refers to a certain sequence of typographical signs that precisely define it: $\{(x, y) \in [0, 1]^2 : (x, 0) \sim (1 - x, 1), (0, y) \sim (1, y)\}$. Alternatively, instead of this algebraic formula, mathematicians use a square with arrows on its edges that indicate how to glue together the quotient space that we call the Klein bottle or surface (in Sect. 9.4 I put forward this geometric definition through the fundamental polygon for the Möbius strip).

The same goes for, say, the Hilbert cube. This mathematical object of infinite dimension does not have its origin in a concept or an idea excogitated at a remove from typographical signs; again, the Hilbert cube is unimaginable. It is called a cube by some analogy to the formal definition of a three-dimensional cube: if the standard cube is the topological product $[0, 1] \times [0, 1] \times [0, 1]$ then the Hilbert cube is $[0, 1] \times [0, 1/2] \times [0, 1/3] \times \dots$ etc. Its meaning is only grasped through the sequence of typographical signs that rigorously define it: $\{(a_n) : \forall n \in \mathbb{N}, 0 \leq a_n \leq 1/n\}$. In addition, this object can be seen as a subspace of the Hilbert space of successions l_2 , one of the first constructed abstract spaces of infinite dimension, whose origin must be located in something as prosaic as Hilbert's own study of certain integral equations, transforming their solution into the solution of a system of infinite linear equations with infinite unknowns (Madrid Casado 2014).

In short, typographical signs written with ink on paper or with chalk on the blackboard (or typed on the computer screen) are the *physicalist* terms of logic

1 yields $0! = 1! / 1 = 1 / 1 = 1$. Obviously, analyzing these examples does not cover the entire problem, which is an open question that requires further investigation.

and mathematics. Mathematics and logic are, based on the references of their field, sciences of typographical materialities. There are no *formal* sciences, i.e. sciences engaged in the study of pure and immaterial (logical or mathematical) forms as if they were ideal sciences that only deal mentally with concepts. The misnamed formal sciences are, in reality, *material* sciences, because their construction demands that the scientist carry out operations with something, with physicalist references such as logical and mathematical glyphs. Every science is constructed by operating on a field of physicalist objects, such that it is impossible for a science to be built by operating exclusively with concepts or ideas. In the case of logic and mathematics, these tangible objects are typographical signs.

Just as the physicist operates with electrons and positrons using certain devices such as particle accelerators and the musician operates with acoustic waves using instruments such as the violin and the piano, the mathematician operates with numbers, straight lines, and circumferences using corporeal numbers, lines, and circles. The role played by the physicist's devices, the musician's instruments, and the mathematician's glyphs cannot be overlooked, because without them we lack access to subatomic particles, music, or mathematical objects.

However, although I have undermined the sharp distinction between formal and empirical sciences, the difference lies in the fact that the terms that form part of the field of logic and mathematics are manmade, whereas this is not generally the case in physics or geology, which start with planets and rocks (on this artifice lies, as I will explain, the ontological privilege of logic and mathematics). When it is asserted that logic and mathematics are a priori and independent of experience, what is actually being said is—as Peirce (2010, 3–4) pointed out—that “the mathematician observes nothing but the diagrams he himself constructs.”

For formalist materialism, as advocated by the intuitionists (and before them, Peirce 2010, 24), formal logic lacks any ascendancy over mathematics, for it is a type of mathematics, i.e. a mathematics with glyphs that operate in a special way (“self-forming”). Bueno (1979b) demarcates formal logic and mathematics by pointing out that logic relates more to *self-forming operations*, with operations that include the reproduction or reiteration of one or more of the operated terms: $\neg(\neg p) = p$; $p \vee p = p$; $p \wedge p = p$; $x \times x = x$; etc. In contrast, mathematics shows a greater presence of *hetero-forming operations* (i.e. not self-forming or idempotent, following George Boole): $a + a = 2a$; $a - a = 0$; $x \times x = x^2$; etc. In short, formal logic is a marginal product of doing mathematics: a mathematics with self-forming glyphs.

Most mathematicians and philosophers are blind to the fact that they held the *suppositio materialis* but failed to realize it. This is illustrated by the mathematician Ernst Schröder, who in his *Lehrbuch der Arithmetik und Algebra* introduced the “One and Only Axiom”, the “axiom of the inherence of the signs”: “It gives the certainty that in all our arguments and inferences the signs inhere in our memory and even more on the paper” (Schröder 1873, 16). However, they often failed to realize it, because they set aside the corporeality of the mathematician and withdrew mathematics into language or thought, without realizing that mathematics disappears if its signs disappear. In this connection, Hilbert (1922, 163) strongly

insisted that “in the beginning is the sign” and that new ideas necessarily correspond to new signs (as happened with the imaginary unit i), thus recalling that a mathematician cannot do without the figure drawn in synthetic geometry or the marks written in arithmetic, algebra, or analytic geometry.

9.4 Knowing Mathematics Is Doing Mathematics

Formalist materialism categorically affirms that mathematics is based on its typographical materiality; however, it simultaneously refuses to completely reduce it to such a level (which would bring us back to inscriptionism), hypostasizing the physicalist *terms*, for in mathematics there are also operations exercised by a mathematician with such terms and *relations* represented by them (to put it semiotically, mathematical signs are not signifiers lacking a signified, although their concept-signified is formed in the manipulation of the signifier-referent). For instance, the Pythagorean theorem is a *relation* with a reality different from the empirical or the mental (although, curiously, more resistant and objective), but its construction invariably requires the *operations* of a mathematician coordinating *terms* such as algebraic signs and/or geometric drawings. This invariant relationship encountered by the mathematician in analyzing the operations exercised on its terms is usually expressed in natural language (“in right triangles the square whose side is the hypotenuse is equal to the sum of the two squares on the other two sides”), even if it subsequently flows into logical and mathematical signs ($a^2 = b^2 + c^2$).¹³ At the end of the chapter I will return to the ontology of mathematics, but for now I should stress that the Pythagorean ratio does not dwell within a realm of Platonic ideas, since it cannot be detached from the world in which we live and act: mathematical relations are dissociable but cannot be separated from a mathematician’s operations or mathematical terms.¹⁴

To set things in order, recall the *Portrait of Luca Pacioli*, a painting attributed to Jacopo de’ Barbari (1495) and depicting how the operative construction of a series of objectual figures determines the mathematical relations (see Fig. 9.1). It perfectly portrays and details the three components (terms, operations, and relations) I have identified in the field of mathematics. Firstly, terms: the circle, the lines, and the triangles drawn on the blackboard (on the left). Secondly, operations: the mathematician’s conduct in manipulating various devices such as the chalk, the blackboard, the compass, and the dodecahedron model (in the center). And, thirdly, relations: Euclid’s *Elements*, Book XIII, Proposition 12 (on the right).

¹³ For Peirce (2010), a , b , and c function here more as indexes than as icons, because in this geometric context they are naming the sides of the right triangle whose drawing would appear contiguous to the proposition formulated by the Pythagorean theorem.

¹⁴ Bueno (1992, 1427).



Fig. 9.1 Portrait of Luca Pacioli by Jacopo de' Barbari (1495)

A further conclusion can be drawn from an analysis of the painting: *knowing* mathematics is *doing* mathematics (Bueno 2000). Mathematics is *know-how*, for Pacioli cannot teach his pupil geometry without geometrizing or arithmetic without calculating, i.e. without solving problems or making proofs and, therefore, without manually operating with the glyphs enclosed on the plane of the blackboard that we call numbers, unknowns, points, straight lines, and curves. As Netz (1999, 53) says, “the action of the proof is literal, and the object of the proof must be the diagram itself [...] the circle of the proof is drawn, not imagined to be drawn.” The philosophy of mathematics subscribed by a more mature Wittgenstein insisted on this point (as seen in one of the quotes heading the chapter; Wittgenstein 1975). In his conversations with the mathematician Friedrich Waismann, Wittgenstein stated, “We *make* mathematics. Just as one speaks of ‘writing history’ and ‘making history’, mathematics can in a certain sense only be made.” (Waismann 1979, 34; a similar assertion can be found in *Philosophical Remarks* §157).¹⁵

Mathematicians do not wear white coats like chemists, but they too are operating subjects: their substances are signs and diagrams; their laboratory is paper,

¹⁵ Moreover, for Wittgenstein, “what we find in books of mathematics is not a *description of something* but the thing itself” (Waismann 1979, 34). “Numbers are not represented by proxies; numbers *are there*” (Waismann 1979, 35 f. 1).

blackboard, and computer screen; and their instrumental apparatus is their hands.¹⁶ As ethnomethodologist Eric Livingston (1986) has remarked in his description of the craft of the “tribe of theorem provers,” manual notebook and blackboard work constitutes the course of mathematical reasoning, although this zigzagging course with erasures and corrections is relegated when presenting the solution.

However, one could object to this materialist view of mathematics: Isn't a more mental than corporeal mathematics possible, a mathematics that is thought or spoken (without hands, papers, or blackboards)? My answer is an emphatical no. Indeed, there have been great blind mathematicians, such as Euler, who was blind for the last 17 years of his life. Euler had a prodigious memory, though, and it could be argued that he reasoned by using his memory as a chalkboard, by *simulating* the surgical operations, just as the expert chess player depicts the board and the position of a game in their head. Ian Hacking (2013) holds that the same goes for Stephen Hawking: his illness prevented him from drawing diagrams, but he had internalized them also. Thus spoke Einstein, who did not use words but images to think mathematically:

“The words or the language, as they are written or spoken, do not seem to play any role in my mechanism of thought. . . The physical entities which seem to serve as elements of thought are certain signs and more or less clear images which can be ‘voluntarily’ reproduced and combined. . . The above mentioned elements are, in my case, of visual and some of muscular type.” (Hadamard 1945, 142–143)

The trained mathematician can, in effect, dispense with ostensibly drawing a straight line; however, as Kant (B 155) argued, he cannot conceive of it without at least drawing it in thought. Nonetheless, it should be noted that even this imaginary drawing remains on the scale of material bodies, because we cannot imagine a straight line with no thickness or a point with no extension, since they would be invisible.

9.5 The Varieties of Mathematical Ideograms

Returning to the blackboard used by Fra Luca Pacioli. For Bueno (1982), only through those drawings on paper, the blackboard, or sand can mathematicians manipulate mathematical concepts by means of appreciable incarnations and determine the relations that lead to theorems. The glyphs that populate mathematics, be they figures or numerals, constitute what Javier De Lorenzo (1994) and, shortly thereafter, Brian Rotman (1997) have called *ideograms*, although their definitions are not entirely equivalent. For De Lorenzo an ideogram is a visual collection of characters or lines, whereas for Rotman it is only a collection of characters, and a diagram is the name reserved for collections of lines, i.e. for the figures. In this

¹⁶ The comparison between mathematicians and chemists can be traced back to Peirce (2010, 40 and 80). Latour (2008, 444) also speaks of the “flat laboratory” of mathematics.

chapter I will employ De Lorenzo's broader definition, specifying in each case whether I am referring to geometric or algebraic ideograms.¹⁷

Countering both those who believe that ideograms are redundant in mathematics and those who believe that natural language is superfluous (because mathematics can become a well-made artificial language), De Lorenzo (1994) highlights how in practice the mathematician continues to manipulate a combination of natural language and ideograms. Yet, doing mathematics does not commence with spoken discourse for subsequent graphical transcription (phonemes cannot replace the glyphs); rather, its original and constitutive point is the ideogram and, from there the essential and by no means auxiliary concurrence of paper and the blackboard.¹⁸ According to De Lorenzo (1994), the ideogram is the nucleus of mathematics, even though natural language complements it, because it conveys the inscriptions when linking certain constructions with others (for example, the steps in a proof or in the resolution of a problem), such that ideogram and text end up forming a unit. Mathematical praxis continuously engages discursive text and geometric or algebraic ideograms.¹⁹

Notable among the pioneers in drawing attention to mathematical ideograms is Brown (1999). In his opinion, apart from substantial heuristic (visualizing and experimenting) power, geometric ideograms possess critical demonstrative power, as they sometimes provide rigorous evidence. While the traditional view inherited from the arithmetization of analysis in the nineteenth century has led us to believe that diagrams are always deceptive (particular cases of a general theorem), Brown points out that purely verbal and symbolic reasoning removed from the visual also errs and, in fact, led to the dead end of logical and set-theoretic paradoxes.²⁰

In respect of the ideograms that populate mathematics, there is room for three positions:

1. Ideograms play a superfluous role in mathematics. In particular, geometric ideograms are useful and serve to illustrate proofs, but they do not prove anything. This iconoclastic position is held by mathematicians such as Lagrange (who presented his 1788 *Mécanique Analytique* boasting that no figure would be found in the book) and Dieudonné (who insisted in the preface to the 1969 *Foundations of Modern Analysis* that he had deliberately refrained from

¹⁷ De Lorenzo's notion of ideogram is indebted to Peirce's notion of diagram (2010, 19, 40 and 46–47), because a diagram was both a figure and a system of equations for the American mathematician and philosopher.

¹⁸ For Rotman (1997, 28) it is also a mistake to believe that mathematical praxis is a part of thought, as if ideograms represented previous objects. Relying on semiotics, Rotman (1988, 2000) posits that numerals determined numbers, because mathematical writing is not subsequent to a nonexistent Platonic intuition that would illuminate the mental concept that would later have to be transcribed.

¹⁹ In the case of Greek mathematics, Netz (1999, 181) has insisted heavily on their mutual dependence: "The text alone is too difficult to follow; the diagram alone is wild and unpredictable. The unit composed of the two is the subject of Greek mathematics."

²⁰ Brown (1999, 133).

including any diagram). In reality, these mathematicians have replaced the geometric ideograms that can lead to error or confusion with algebraic ideograms, traditionally considered less ambiguous and more rigorous.²¹

2. In practice it is impossible to do without the use of geometric and algebraic ideograms, but this is due to our cognitive limitations. An ideal mathematician with unlimited imagination and memory could do without them. This position corresponds to Brouwer, who assigned a wholly accessory character to the ideogram, because in his opinion mathematics was a pure mental construction. However, he recognized the pragmatic need for language and signs to communicate findings. As paradoxical as it may seem, in his work as a topologist Brouwer always reasoned by filling papers with abstract drawings that resemble paintings by Kandinsky.²²
3. Ideograms play a substantive, irreplaceable role in mathematics. This last position corresponds to the position I have been taking: the use of ideograms is not a pragmatic question but rather one constitutive of mathematics. Like the other sciences, mathematics comes from the development of certain techniques, graphical in this case, related to writing glyphs (figures, numerals, and letters). The combination of ideograms and natural language is what characterizes mathematics, beyond the conception that reduces them to a formal language and aspires to a figureless geometry or to an algebra lacking formulas materialized on a two-dimensional sheet or chalkboard (see Fig. 9.2). As I will show below, we find ideograms throughout the history of mathematics, from Euclidean geometry to modern topology, including algebra and analysis.

Our ancestors acquired protomathematical knowledge as a result of everyday actions such as counting, ordering, measuring, collecting, correlating, etc. (Poincaré 1902b; Kitcher 1983; MacLane 1986). Today, children at school learn the primitive concepts of mathematics following the same actions as our ancestors. The concept of number is acquired by counting, ordering, or measuring using a yardstick; the concept of set, by collecting things; and geometric shapes, through movement or construction.²³ In the wake of Piaget, Lakoff and Núñez (2000) speak of an “embodied mind” and underline how the body interacts with the world to form the primary mathematical concepts. For instance, the experience that lies at the base of primitive arithmetic is the manipulation of solid bodies, not of fluids, because one pebble and another pebble make two pebbles, but one drop of water and another drop of water do not make two drops of water, but only one. This observation links with the privileged status that materialism and other philosophical systems grant to

²¹ Mancosu (2006, 14–15), Giaquinto (2008, 22–23).

²² Madrid Casado (2018a, chap. 3).

²³ For example, prism in Greek means something sawn and cylinder something that has been rolled up. As Netz (1999, 124) points out: “One should make an effort to realize how mundane Greek mathematical words are. We translate *tome* by ‘section’, *tmeme* by ‘segment’, *tomeus* by ‘sector’. Try to imagine them, as, say, ‘cutting’, ‘cut’ and ‘cutter’.”

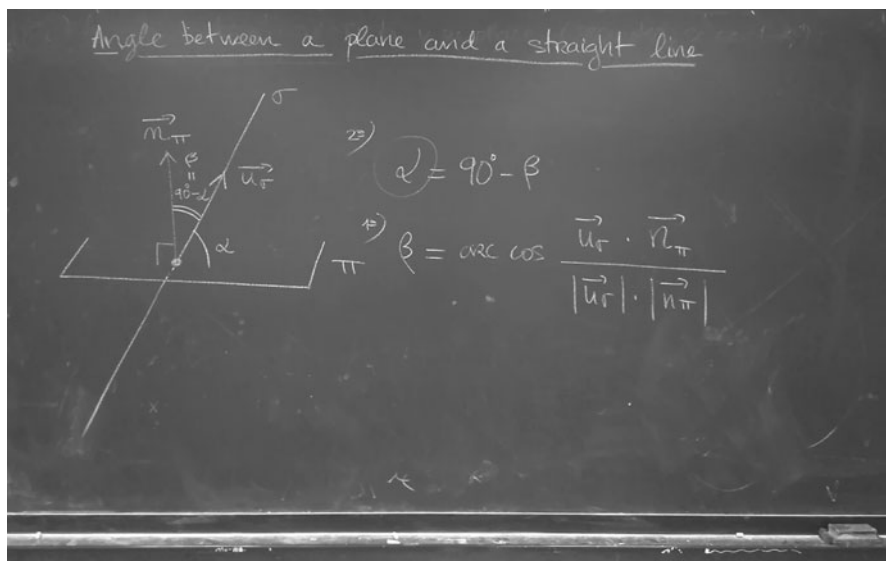

Fig. 9.2 As this chalkboard shows, mathematics combines natural language (above) with geometric (left) and algebraic (right) ideograms

bodies, to the solid state (Bergson 1907; Bueno 2006). Mathematics in a fluid world or on another scale without agile and moveable objects would be different.²⁴

My argument is that mathematics arises from the conjunction of this series of manipulative experiences with the technique of writing, for the mathematician is a sort of scribe. As Hacking (2009) has indicated, the importance of the hands and not just the mind should be stressed. Armed with various instruments such as styluses and or wedges, hands make lists and diagrams and draw mathematical glyphs on papyrus, clay tablets, and sand. Among these glyphs, two different types begin to emerge. On the one hand are the arithmetic glyphs (numerals and literals) relating to the counting process (natural numbers). On the other hand are the geometric glyphs (segments and figures) relating more to the operation of measuring (the real continuum). Thus arises the aporia between the arithmetic discrete and the geometric continuous, which permeates the history of mathematics.²⁵ The incommensurability between arithmetic and Pythagorean geometry can be explained by the difference between two techniques with very different glyphs: certain are discrete (arithmetic figures) and others are continuous (geometric lines).

²⁴ Poincaré (1902b, chap. 4).

²⁵ Stilwell (2010, 3).

In the first science of Greek geometry, the role of the ideogram is patent. Every proof in Euclid's *Elements* involves a natural-language text and a figure (see Fig. 9.3). The geometric ideogram cannot be removed from the proof, for it is more than a mere visual aid. Firstly, because graphical prose cannot be deduced from discursive prose, since we can describe a triangle with words but cannot draw it. And, secondly, because the proof itself demands the graphical construction that the text—with its linear character—cannot carry out, and geometric rationality is not given at a remove from matter (as if there were original mental contents), but rather depends on the collection of points, lines, and arcs of circumference carried out by the geometrician with the help of the ruler and the compass (Netz 1999; Manders 2008; Bueno 2009a). In fact, the original meaning of Euclid's propositions that, according to Proclus's classical distinction, have to do with problems rather than theorems, is that a certain construction can be carried out (and therefore end with the clause "which had to be done" [*hóper édei poiésai*], instead of with the "which had to be demonstrated" [*hóper édei deíxai*] reserved for theorems, where some property or relation of already constructed objects is sought to be proved).

The same considerations I have made about Euclidean ideograms could be made about other geometric ideograms such as Euler circles or Venn diagrams. The role of ideograms is no less important in arithmetic or algebra. Arithmetic and algebraic ideograms are not visual collections of dots, lines, and curves, but collections of numerals, literals, and signs (although some algebraic ideograms, such as the "lattice" associated with Ruffini's rule or homological diagrams, involve geometric lines, see Fig. 9.4).

Among arithmetic ideograms, the most important is the system of numbers. With regard to algebraic ideograms, the algebraic notation introduced by Descartes must be mentioned. However, note must also be made of its geometrical background, because x and y were used to manipulate straight-line segments. For Newton, as for the Greeks, the product xy still referred to a rectangle with sides x and y .²⁶ Over time, algebra ceased to rely on geometry, and x and y began to take on independent meaning (until Grassmann's arithmetic manual of 1861, xy continued to symbolize an area).

What algebraic ideograms offer as novelty compared to geometric ideograms is that they impose a "linearization" of mathematics (De Lorenzo 1994). While geometric glyphs are continuous and require two-dimensional treatment (the mathematician can return to what is higher or to the left in the drawing, drawing new lines), algebraic glyphs are discrete and require one-dimensional, sequential, or serialized manipulation, such as natural language (from top down, from left to right).

²⁶Historically, analytic geometry was built on synthetic geometry, and this phylogenetic connection explains the interderivability phenomena (i.e. that we can deduce equivalent theorems in both). In fact, the demonstration that $(a - b)^2 = a^2 + b^2 - 2ab$ (and therefore, implicitly, that the product of $-b$ by itself is taken to be plus b^2 , i.e. that minus times minus is plus) originally depended on the geometrical ideogram of Proposition 7 in Book II of Euclid's *Elements*, which presents a square of side a from which another square of side b is subtracted (it was thus presented, for example, by Edme Mariotte in the 1678 *Essai de Logique*).

LIBRO PRIMERO DE

¶ En los triangulos rectangulos el quadrado que es hecho de el lado que esta opuesto al angulo recto es ygual a los dos quadrados que son hechos de los lados que contienen el angulo recto,

Sea el triangulo rectángulo. ABC . que tenga recto el angulo BAC . digo que el quadrado que es hecho del lado BC . es ygual a los quadrados que le hazen de BA . y de AC . Describafse, por la. 46. dela. BC . el quadrado $BDEC$. y por la misma, de la BA . y dela, AC . los quadrados $ABZL$. $ACKT$. y por el punto A . tirese. AL . paralela con la BD . CE , por la proposición. 11. y por la. 1. petición tirese AD . CZ . y por que los angulos BAC . BAL son rectos. Luego tiradas dos lineas rectas. AG . AI . desde una linea recta. AB . y desde un punto en ella. A . no hacia unas mismas partes hace de una y otra parte angulos yguales a dos rectos, por la. 14. proposición)

luego es derecho esta la. AC . AI . y por esto tambien BA esta es derecho de. AT y por que el angulo. DBC . es ygual al angulo. ZBA . por que cada uno de los es recto: pongase comun el angulo ABC . Luego todo DBA es ygual a todo el angulo ZBC . y por que las dos. AB . BD . son yguales a las dos BZ . BC . la una a la otra, y el angulo. DBA es ygual al angulo. ZBC . luego la base. AD . por la. 4. proposición, es ygual a la base. ZC . y el triangulo. ABD . al triangulo. ZBC . es tambien ygual. y el paralelogramo. BL . por la. 4. 1. es doble del triangulo. ABD

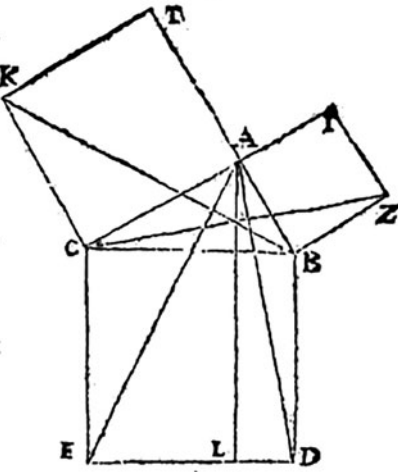

Fig. 9.3 Page with an ideogram of synthetic geometry: the Pythagorean windmill in Euclid's Elements translated into Spanish by Rodrigo Zamorano (Sevilla 1576)

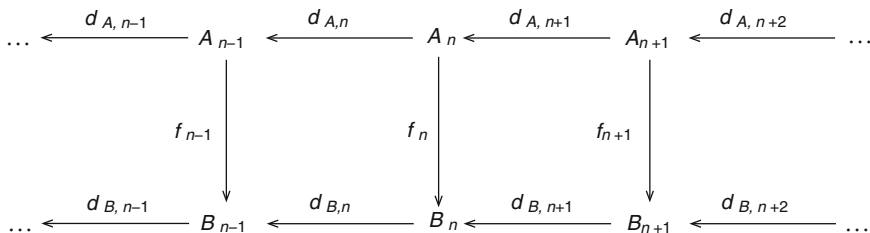

Fig. 9.4 An algebraic ideogram: a homological diagram

$$\lim_{x \rightarrow \infty} \frac{x}{x^3 + 5} = \lim_{x \rightarrow \infty} \frac{1/x^2}{1 + 5/x^3} = \frac{\lim_{x \rightarrow \infty} 1/x^2}{\lim_{x \rightarrow \infty} 1 + 5/x^3} = \frac{0}{1} = 0.$$

Fig. 9.5 An analytical ideogram: a chain of limits

With algebraic ideograms, we remain within the framework of the paper or the blackboard, but mathematical praxis has been restructured on the plane of the sheet or the blackboard, such that we use equations to manipulate the curves as if they were numbers.

As the eighteenth and nineteenth centuries progressed, new ideograms from infinitesimal calculus, analysis (see Fig. 9.5), set theory, and logic (such as Frege’s two-dimensional conceptography and Peano’s more manageable one-dimensional pasigraphy) were interspersed into mathematical discourse. It is important to insist on the fact that even the fundamental theorems of nineteenth-century analysis were accompanied by geometric ideograms that made clear the manipulation of the functions of which the statements speak. As Brown (1999) remarks, it is often said that the rigorous proof of Bolzano’s theorem is the analytical proof given by Bolzano himself and culminates in the arithmetization of analysis throughout the nineteenth century. Bolzano’s theorem was known to be true as a result of these geometric ideograms of great explanatory and visualizing power (see Fig. 9.6); what Bolzano did was offer another proof, in line with another methodology, which confirmed the theorem. (However, as Giaquinto (2008) points out, the appearance of teratological functions, i.e. continuous functions that cannot be visualized such as the Weierstrass function, ended up making analytical proving essential.) Certain books on analysis may lack figures, but “sophisticated mathematics books which have no diagrams in them are read by people who earlier read many books which did contain pictures” (Brown 1999, 132).

With these examples I am trying to show the plurality of the mathematical ideograms and that geometric ideograms are the first analogue of mathematical ideograms, since the algebraic ideograms are frequently based on prior geometric ideograms, in spite of the fact that it is commonplace to consider the figures and diagrams as lacking in rigor. Paradoxically, geometric ideograms have gained a new appreciation with the crystallization of topology in the first third of the twentieth century (Madrid Casado 2018a; see Fig. 9.7).

Fig. 9.6 Geometric ideogram corresponding to Bolzano’s theorem: a continuous function that takes values from opposite signs at the extremities of an interval is annulled inside the interval

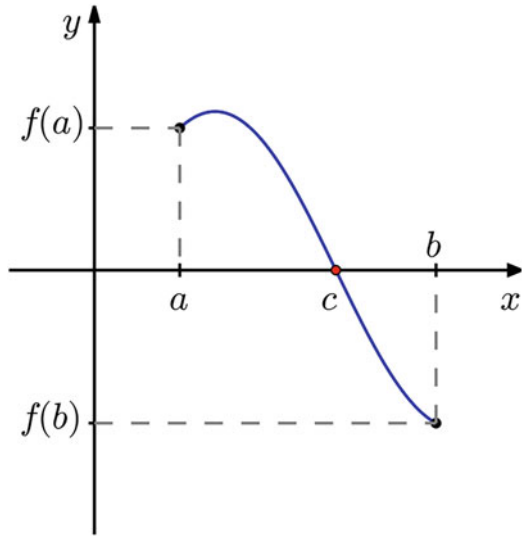
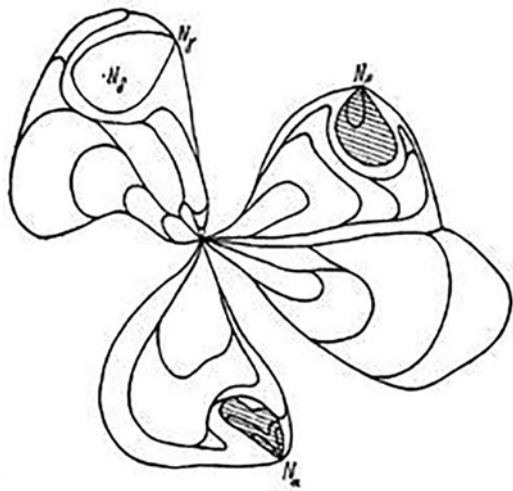

Fig. 9.7 A topological ideogram



In fact, for the topologist the Möbius strip is not reduced to a quotient set (to the algebraic ideogram $\{(x, y) \in [0, 1]^2 : (x, 0) \sim (1 - x, 1)\}$); in fact, they frequently manipulate it by means of a convenient two-dimensional geometric ideogram (see Fig. 9.8). While the algebraic ideogram “linearizes” the strip, the geometric ideogram immerses the three-dimensional corporeal strip on the plane of the paper by exploiting the two-dimensionality of the page. A similar thing happens in knot theory and graph theory (Brown 1999), where the graphical notation makes it possible to represent the knots and graphs on the paper’s two dimensions (Fig. 9.9).

Moreover, new branches of mathematics, such as fractal geometry and chaos theory, assiduously employ geometric ideograms, albeit no longer drawn by hand on

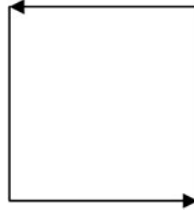

Fig. 9.8 Ideogram of the Möbius strip

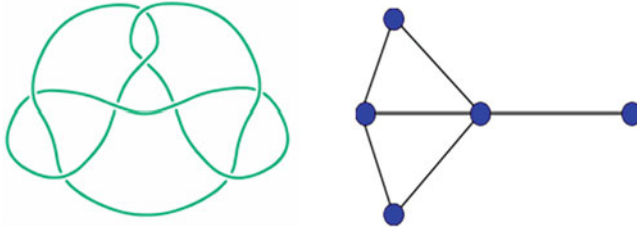

Fig. 9.9 Ideograms corresponding to a knot and a graph

paper or on the blackboard but by a computer on a screen (Mancosu 2006; Madrid Casado 2016). This emphasizes the role of the computer as a device—like a ruler or a compass at one time—serving mathematicians, not only to carry out computational tests (such as the four color theorem or the classification of finite groups) or obtain empirical evidence (on the Riemann hypothesis or the estimate of the Feigenbaum constant), but also to produce geometric ideograms impossible to draw by hand, such as the Mandelbrot set or the Lorenz attractor.²⁷

Looking at the main ideograms of mathematics, it can be seen that mathematical concepts are continuously reified, compulsively materialized. We think mathematics when we write mathematics. This explains why the two key places of mathematical research are, precisely, the paper and the blackboard. While paper is reserved for particular research and its final product (the article), the blackboard dominates collective research and teaching-learning.

²⁷ It should be stressed that even in this digital age, where many calculations are solved by computer, surgical operations are still present. On the one hand, behind the computer program, since the algorithm reproduces human operations on another scale. And, on the other hand, on the computer screen, which shows the mathematical expressions that are typed manually. From the point of view of formalist materialism, a computer that performs mathematical calculations is not a sort of mysterious brain, but rather a machine that manipulates signifiers and that is therefore capable of doing mathematics.

9.6 Universality and Necessity for Ideogrammatic Reasoning

As Peirce (1976, IV 47–48) realized, all mathematical reasoning is ideogrammatic:

All mathematical reasoning is diagrammatic [...] By diagrammatic reasoning, I mean reasoning which constructs a diagram according to a precept expressed in general terms, performs experiments upon this diagram, notes their results, assures itself that similar experiments performed upon any diagram constructed according to the same precept would have the same results, and expresses this in general terms. This was a discovery of no little importance, showing, as it does, that all knowledge without exception comes from observation.

Mathematical reasoning needs to establish some ideogram: in geometry, some figure whose parts are named with letters, and in algebra, some arrangement of letters and numbers. The ideogram is constructed so that it conforms to the hypothesis of the theorem, but the mathematician strives to construct it in a generic manner, without it containing special characteristics that may influence reasoning. According to Peirce (2010, 28) in “The Essence of Mathematics”, “How it can be that, although the reasoning is based upon the study of an individual schema, it is nevertheless necessary, that is, applicable to all possible cases?” To paraphrase Poincaré, it is about solving the paradox that “les mathématiques sont l’art de raisonner juste sur une figure fausse.”

Defending the necessity for mathematical theorems involves explaining why the concrete particularities of the ideogram are irrelevant to the culmination of the proof.²⁸ Theorem 47 in Euclid’s Book I is proved for a singular right triangle, not for all triangles, in the same way that Bernoulli and Euler solved the Riccati equation before their eyes and not another equation. Idealist philosophy may appeal to Platonic ideal forms or Kantian mental schemes to ensure that the imperfections of the ideograms are unimportant; the materialist philosopher, though, must flee from this metaphysics, since it leaves the matter unexplained, as it again underestimates the importance of the ideograms by neglecting that “theorematic reasoning invariably depends upon experimentation with individual schemata” (Peirce 2010, 28).

Peirce himself (2010, 28) foreshadowed part of the answer:

Thinking in general terms is not enough [in mathematics]. It is necessary that something should be DONE. In geometry, subsidiary lines are drawn. In algebra permissible transformations are made. Thereupon, the faculty of observation is called into play. Some relation between the parts of the schema is remarked. But would this relation subsist in every possible case? [...] Generally speaking, it may be necessary to draw distinct schemata to represent alternative possibilities.

In other words, it is not enough to look at the ideogram, you have to manipulate it and even modify it. For example, when proving the law of cosines, the mathe-

²⁸ I understand the necessity for a mathematical theorem in the sense that the thesis applies to all possible cases according to the hypotheses and within the framework of the theory in which it is formulated. I introduce this specification because $2 + 2 = 4$ necessarily in N , but $2 + 2 = 1$ necessarily in Z_3 .

matician distinguishes several cases, depending on whether the triangle is acutangle or obtusangle, since drawing the height of the triangle in the ideogram determines a different proof (were the triangle a right triangle, the Pythagorean theorem would be recovered).²⁹ Yet, within each case, why does the acutangle or obtusangle triangle drawn represent all possible acutangle or obtusangle triangles? The answer is because the geometric ideogram is accompanied by a text in natural language, with which it is connected as a result of the fact that the parts of the ideogram are named with letters and which implicitly stipulates under what conditions each figure can vary without the proof falling apart.³⁰ In the example of the law of cosines, in the obtusangle case, it makes no difference whether the obtuse angle of the triangle drawn is 100° or 120° , because its exact measurement does not intervene in the proof and it is enough to suppose that $\alpha > 90^\circ$.

Following the six steps that Proclus distinguished in the proofs in *Commentary on the First Book of Euclid*, the second stage (*ekthesis*) presented a concrete ideogram of application of the statement through the clause “let...” and the use of letters designating its parts. The Greek saying “let AB be a line” is equivalent to the current expression “let any line” or “take any two points” and neutralizes the particular components of the geometric ideograms so that the triangle drawn can represent all the triangles, in the manner that the algebraic ideogram x can visibly and tangibly represent all numbers without distinction (when it is preceded by a quantifier: $\forall x \in R$). In addition, the third or delimitation stage (*diorism*) set, if necessary, the conditions of the proof. Thus, for example, Proposition 22 of Book I states that it is only possible to construct a triangle with three segments if the sum of two of them is greater than the third. In short, if certain specifications are respected, mathematical ideograms make inferences possible. Geometrical and/or algebraic ideograms present certain relations (those presupposed in the hypothesis of the theorem) and, if they are manipulated in a regulated and controlled way,³¹ enable new relations to be discovered (those enunciated in the thesis of the theorem).

While the problem of the necessity for mathematical reasoning is an internal question, the problem of its universality is, in principle, an external question. It is a question of accepting, denying or qualifying the assertion by Paul Du Bois-

²⁹ In the Greek approximation of the law of cosines as a difference of areas, this distinction corresponds to Propositions 12 and 13, Book I in Euclid.

³⁰ Manders (1995, 92–93; 2008, 69) here introduces the difference between coexact or topological properties (two straight lines intersecting) and exact or metric properties (two segments being congruent) in the appearance of the geometric ideogram. Unlike exact properties, coexact properties are stable under disturbances of the drawn figure. Manders observes that the inference of coexact or topological properties in Euclidean geometry depends solely on the geometric ideogram, while the inference of exact properties requires something extra: an argument in the text accompanying the figure. This distinction can be coordinated with the one that Netz (1999, 19 and 35) makes between immediate assertions from the ideogram and assertions mediated by the ideogram.

³¹ Manders (1995, 96–104; 2008, 70) speaks here of “diagram quality control theory.”

Reymond (1887, 221): “Si les habitants de Mars possèdent une Analyse, elle doit être identique à la nôtre, dans toutes ses parties essentielles.”

A Platonic philosopher of mathematics would share Du Bois–Reymond’s assertion, based on that mathematics is universal-formal. It is universal because its objects are *universal*, in a Scholastic sense. It is formal because mathematical knowledge brings us closer to the ways in which the demiurge or God would have ordered the world. From a materialist perspective, the universality of mathematical theorems can be defended without falling back on hypostatizing metaphysics, thus attributing to mathematics a universality that is not *formal* but *material* (Bueno 1982). It is an operational universality based on the recurring operations of a *corporeal subject* (endowed with a brain, hands, larynx, and striated muscles) and not the operations of a *metaphysical subject* (endowed with a soul, mind, or intuition).

Logic and mathematics are of course canons of human rationality, not because they are the *a priori* features of the universe, but because their terms are artifacts made by men on paper or slate that we always have *at hand*. They are marks made with the hands, transcendental in a positive sense, because wherever there is a man they will be able to be drawn. It is the body and not just the mind that accompanies all our rational representations. For instance, the system of numbers operates as a kind of portable measuring rod, which we inevitably carry with us, because wherever there is a man the numerical glyphs can be drawn or, in general, ideograms can be put together. Mathematical theorems are not deposited in the heavens or in thought, but in their typographical manifestations. Accordingly, the ontological privilege of logic and mathematics does not rest on any Platonic or Pythagorean postulate, but on the fact that graphical techniques only need hands and paper (not laboratories or large experimental devices, such as chemistry or physics).³²

Present-day cosmologists interested in the anthropic principle—such as Max Tegmark (2008)—explain the universality of mathematics in similar fashion. A universe where mathematics did not work would be a universe where signs would melt and segments would expand chaotically, as in a painting by Salvador Dalí, such that it would be impossible to make any calculation or geometric construction. However, in this kind of world, there would be no observers who could verify the impossibility of mathematics. Consequently, looking now at our universe, the conditions for the existence of corporeal beings like us lie behind the extension of mathematical practices. As can be seen, the anthropic character of this argument, linked to the scale of the operating subject, is hardly foreign to formalist materialism (Madrid Casado 2018b).

However, it is worth insisting that the universality of the Pythagorean theorem is based less on the repeatability of the original ideogram and more on the recurrence of the ideogram’s internal processes of construction (Bueno 2009b). It is not a question of basing the universality of mathematical theorems on the identification of certain diagrams with others, on a photocopy or clone of the Euclidean ideogram (a

³² Peirce (2010, 69).

kind of empirical induction like Stuart Mill). The Pythagorean theorem is universal not only because the ideogram is repeatable, because the artificial figure of the *windmill* can be drawn again and again, but also because, as I explained, the processes of repetition are incorporated in the original operative construction: “be any right triangle”, “let $AB\Gamma$ be a right triangle”, etc. (the phases of *ekthesis* and *diorism*) (Netz 1999). The ideogram is repeatable because the operations leading to the drawing of the ideogram are repeatable. As Bueno (2009a, 2) says, “If the relations obtained on singular graphical terms can assume a universal character, it is due to the capacity to reproduce themselves indefinitely by the *work of the operating subject* in the indefinite space of the plane.”³³ Once closed, the process of proof contains the principles of its universal recurrence: the possibility, as Peirce (2010, 80) maintains, of replicating the iconic experiment ad libitum.

But there’s more. This materialist conception of mathematics makes it possible to offer an alternative explanation to the “miracle” of the effectiveness of mathematics in the natural sciences (Wigner 1960). Over the ages, physicists and mathematicians have never ceased to express their astonishment at the fit between physical matter and mathematical forms, coming to imagine that God is mathematical or that the cosmos is a mathematical structure in itself (Galileo, Einstein, Penrose, Tegmark). Having removed mathematical objects from the Earth and from physical objects, Platonism turns the usefulness of mathematics in the real world into mystery, as Kitcher (1983) points out. It obfuscates our understanding as to why some objects are good at dealing with others.

My argument is that the Book of Nature is not written in mathematical characters, as Galileo sought, but that scientists write the Book of Nature using mathematical characters. For Bueno (2000), instead of saying that Apollonius’s conics are applied to planetary trajectories, it must be said that planetary trajectories are projected on a surface (the sand of a beach, the paper, the blackboard, or the computer screen) to thus be integrated into a system of certain curves (in fact, it is on the plane of the paper or the blackboard where the planetary orbits are visualized). It is not that mathematics is applied to the real world, but rather that certain parts of the real world are integrated into the field of mathematics by means of certain operations (such as projection, in the case of planetary conics). During the Scientific Revolution that took place between the sixteenth and eighteenth centuries, the terrestrial globe, a large portion of the supralunary world, and a good part of the sublunar world were accommodated in the heart of mathematics as a result of the operations performed by cosmographers, astronomers, physicists, engineers, etc. For example, when an astronomer armed with an astrolabe or quadrant observed the position of a star, the

³³ Netz (1999, 246 and 266) puts forth a similar explanation of the universality of mathematics: “Generalisability [of result] is then a derivative of repeatability [of proof] [. . .] The simplification of the universe, both in terms of the qualitative diagram and in terms of the small and well-regulated language, makes inspection of the entire universe possible”. As Latour (2008, 454 f. 16) states, “the world does respond to that practice [about lettered diagrams] with fecundity because of the artificiality of the flat laboratory.”

device contained the goniometric circumference, which linked the observation taken with spherical geometry.

The power of mathematics to explain regions of reality does not spring from the world, but from the fact that the world takes its terms from the action of human operations.³⁴ At times, the mathematical model is purposely designed for this purpose (as Newton did with the calculation of fluxions, to describe accelerated motion). Other times, a previous mathematical theory is used (as Kepler did with Apollonius's conics, which were not introduced by the Greeks to study planetary movements). However, there are parts of the world that are not integrated in the field of mathematics: either because this manner of taking its terms fails partially (thus, determinist chaos models alert us to the limits of predictability of certain physical systems) or completely (historical facts or psychological experiences, which lack mathematical expression). Reciprocally, there are many mathematical terms without factual correlation (such as inaccessible cardinals).

Interestingly, one of the most successful applications of mathematics is that of algebra to geometry between the sixteenth and seventeenth centuries. This application was not predetermined beforehand for, in the same manner as the world is not written in mathematical characters, synthetic geometry did not contain in its core the rudiments of analytic geometry. It was Descartes's operations that thoroughly transformed the geometric materials to successfully bring them into algebraic symbolism. Only after the introduction of the axes and coordinates could the French mathematician associate an equation to each curve and, therefore, move from geometry to algebra and, after solving the problem, from algebra to geometry.

Mathematical models are, in short, like geographical maps. We only remember those that succeeded in guiding travelers, forgetting those that failed and even the fact that well-designed ones impose certain simplifications on reality.

9.7 Conclusion

Objects in the field of mathematics do not *exist prior* to the process of their construction. Complex, real, rational, and integer numbers are the work of man. Even natural numbers do not exist prior to counting or ordering operations. Think

³⁴ To explain the versatility of mathematics—one single formula can serve to represent a movement or the intensity of the electric current—Bunge (1985, 34) and Romero (2018, 98) argue that the status of mathematical objects as fictions or conceptual artifacts endows them with a certain ontological neutrality that is precisely what allows them to travel, so to speak, through different levels of the world or reality. However, certain mathematical structures may still carry a certain ontological load. Thus, in the context of the creation of quantum mechanics, for Schrödinger, if there was an equation of waves, there had to be waves. In contrast, for Heisenberg, matrix mechanics pointed to a corpuscular view of the atomic scale. The difference in mathematical approach (analytical vs. algebraic) resulted in a very different conception of the microcosm (continuous vs. discontinuous), which was only partially solved by Dirac, Weyl, and Von Neumann (Madrid Casado 2011).

that the zero was unknown to Greeks and Romans. But these man-determined numerical sets end up alienating him and gaining autonomy. Mathematical relations are not genetically independent of the subject that establishes them, of the ideogram drawn, although the structure of relations, once given, makes it possible to segregate the subject, for these relations between terms turn out to be invariant under the operations of any subject (Bueno 2000). (Mathematical structures are hence independent of any particular subject, but not of the class of all subjects.) In the same way that the musician uses the organ to produce new sounds that do not exist previously in nature, the mathematician constructs new entities, such as numerical sets and geometric spaces, that must be considered an extension of reality, i.e. *hyperrealities* (Bueno 1992, 2013).

For a Platonic, the parabola, as was determined as a conical section by the Greeks, has always been of degree 2. In my view, this curve only begins to have degree when it is associated, as a result of the introduction of Cartesian coordinates, with a second-degree polynomial. The degree is an original property of the polynomials, not of the conical section. Only after the elaboration of analytic geometry can we identify the geometric ideogram and the algebraic ideogram, because it is the algebraic notation that creates it and determines the degree, thus illustrating that mathematical objects are not discovered as if they were perfect, finished realities waiting to be known. There is no reason to think that Pythagorean triples or topological vector spaces were already present in the mind of Paleolithic men. With their associated ideograms and concepts, mathematicians of flesh and blood make and expand the ontology of mathematics (Carter 2004; Latour 2008).

As a result, a *historical ontology* emerges, one in which it makes sense to talk about the history of mathematical objects (Hacking 2002). The paradox is that these objects, which form a sort of extended reality or hyperreality, are the output of a historical and social process, but they cannot be considered as contents of either culture or nature (Bueno 2000). Indeed, if mathematical structures were cultural, to what culture do they belong? Didn't the Pythagorean theorem break away from Greek culture and prove valid for all cultures? But, reciprocally, were mathematical structures natural, where would they be? Are right triangles or Euclidean space found in nature?

Rather, it is the nature-culture dilemma that must be discarded as superficial and Manichean (Bueno 2002). Mathematical contents form part of a third class beyond nature and culture. This idea that mathematical objects make up a third class of objects structurally beyond though genetically related to natural and cultural objects is hardly foreign to mathematicians like Davis and Hersh (2012). As Hersh (1997) also insists, we are not in the midst of a Platonic kingdom or a Popperian third world, because mathematical structures cannot be completely detached from the glyphs or from the operations of the mathematical scribe.

The image of mathematics and logic that this chapter seeks to transmit is one of pluralism (Bueno 2000). In purity, there is no one single mathematics but rather multiple mathematics (geometry, arithmetic, algebra, analysis, probability theory, etc.), just as there is no one logic but many logics (classical logic, intuitionist, many-valued, fuzzy, etc.). Mathematical sciences are by no means a unitary system

(reducible to set theory or to a collection of formal systems), but rather a sort of phylogenetic tree as from its technical antecedents. A cross section of this tree from which the different branches of mathematics hang reveals that different styles of doing mathematics can coexist in the same historical period (De Lorenzo 1971). A longitudinal look reveals how each domain of mathematics evolves, how over time certain styles stagnate (for instance, the study of algebraic invariants, which were highly popular in the nineteenth century), others hybridize (algebra and geometry in the crystallization of analytic geometry), and some even integrate others, redefining their basic notions and reconstructing their theorems (as integral calculus did with indivisible calculus or Riemannian geometry with the old Euclidean geometry and new non-Euclidean geometries) (Kitcher 1983).

In conclusion, from the tenets of Gustavo Bueno's formalist materialism, the reconsideration of the role of mathematical ideograms blurs the boundary between mathematics and empirical sciences. Despite the artificial nature of its terms, mathematics behaves like any other science, like chemistry or biology; the appearance of Greek geometry was the scientific revolution par excellence, at the same level as the revolution that took place in the seventeenth century. No scientific truth is superior in age to the theorems of Thales, Pythagoras, or Euclid.

References

- Benacerraf, P. 1965. What Numbers Could Not Be. In *Philosophy of Mathematics: Selected Readings* [1983], ed. P. Benacerraf and H. Putnam, 272–294. Cambridge: Cambridge U.P.
- Benacerraf, P. 1973. Mathematical Truth. In *Philosophy of Mathematics: Selected Readings* [1983], ed. P. Benacerraf and H. Putnam, 403–420. Cambridge: Cambridge U.P.
- Bergson, H. 1907. *L'Évolution créatrice*. Paris: Félix Alcan.
- Brown, J.R. 1999. *Philosophy of Mathematics. An Introduction to the World of Proofs and Pictures*. London: Routledge.
- Bueno, G. 1972. *Ensayos Materialistas*. Madrid: Taurus.
- Bueno, G. 1979a. Operaciones autoformantes y heteroformantes I. *El Basilisco* 7:16–39.
- Bueno, G. 1979b. Operaciones autoformantes y heteroformantes II. *El Basilisco* 8:4–25.
- Bueno, G. 1982. El cierre categorial aplicado a las ciencias físico-químicas. In *Actas del I Congreso de Teoría y Metodología de las Ciencias*, 101–175. Oviedo: Pentalfa.
- Bueno, G. 1992. *Teoría del cierre categorial*, 5 vols. Oviedo: Pentalfa.
- Bueno, G. 2000. Las matemáticas como disciplina científica. *Ábaco* 25/26:48–71.
- Bueno, G. 2002. *Der Mythos der Kultur. Essay einer materialistischen Kulturphilosophie*. Bern: Peter Lang (Übersetzung und Einleitung von Nicole Holzenthal).
- Bueno, G. 2006. Filosofía de las piedras. *El Catoblepas* 58:2.
- Bueno, G. 2009a. Poemas y teoremas. *El Catoblepas* 88:2.
- Bueno, G. 2009b. Poesía y verdad. *El Catoblepas* 89:2.
- Bueno, G. 2013. *Sciences as Categorical Closures*. Oviedo: Pentalfa (translated by Brendan Burke).
- Bueno, G. 2016. *El Ego trascendental*. Oviedo: Pentalfa.
- Bueno, O. 2009. Mathematical Fictionalism. In *New Waves in Philosophy of Mathematics*, ed. O. Bueno and Ø. Linnebo, 59–79. Hampshire: Palgrave Macmillan.
- Bunge, M. 1985. *Treatise on Basic Philosophy. Vol. 7. Epistemology and Methodology III: Philosophy of Science and Technology. Part I: Formal and Physical Sciences*. Holland: Kluwer.

- Bunge, M. 1997. Moderate mathematical fictionism. In *Philosophy of Mathematics Today*, ed. E. Agazzi and G. Darvas, 51–71. Dordrecht: Kluwer.
- Bunge, M. 2006. *Chasing Reality: Strife over Realism*. Canada: University of Toronto Press.
- Carter, J. 2004. Ontology and mathematical practice. *Philosophia Mathematica* 12(3):244–267.
- Corfield, D. 2003. *Towards a Philosophy of Real Mathematics*. Cambridge: Cambridge U.P.
- Crowe, M. 1988. Ten misconceptions about mathematics and its history. In *History and Philosophy of Modern Mathematics*, ed. W. Aspray and Ph. Kitcher, 260–277. Minneapolis: University of Minnesota Press.
- Davis, Ph.J., and R. Hersh. 2012[1981]. *The Mathematical Experience*. Boston: Birkhäuser.
- De Freitas, E., and N. Sinclair. 2014. *Mathematics and the Body: Material Entanglements in the Classroom*. New York: Cambridge U.P.
- De Lorenzo, J. 1971. *Introducción al estilo matemático*. Madrid: Tecnos.
- De Lorenzo, J. 1994. El discurso matemático: ideograma y lenguaje natural. *Mathesis* 10:235–254.
- De Lorenzo, J. 1998. *La matemática: de sus fundamentos y crisis*. Madrid: Tecnos.
- Du Bois-Reymond, P. 1887. *Théorie générale des fonctions*. Paris: A. Hermann.
- Ferreirós, J., and J.J. Gray. (eds.) 2006. *The Architecture of Modern Mathematics: Essays in History and Philosophy*. Oxford: Oxford U.P.
- Field, H. 1980. *Science Without Numbers: A Defense of Nominalism*. Oxford: Blackwell.
- Field, H. 1989. *Realism, Mathematics & Modality*. Oxford: Blackwell.
- Giaquinto, M. 2008. Visualizing in Mathematics. In *Mancosu* (2008, 22–42).
- Hacking, I. 2002. *Historical Ontology*. Harvard: Harvard U.P.
- Hacking, I. 2009. *Scientific Reason*. Taipei: NTU Press.
- Hacking, I. 2013. Review of Hawking incorporated: Stephen Hawking and the anthropology of the knowing subject. *Common Knowledge* 19(3):553–554.
- Hacking, I. 2014. *Why Is There Philosophy of Mathematics?* Cambridge: Cambridge U.P.
- Hadamard, J. 1945. *The Psychology of Invention in the Mathematical Field*. Princeton: Princeton U.P.
- Hartimo, M. (ed.) 2010. *Phenomenology and Mathematics*. Dordrecht: Springer.
- Heine, H.E. 1872. Die Elemente der Funktionslehre. *Crelle's Journal für Mathematik* 74:172–178.
- Hersh, R. 1997. *What Is Mathematics, Really?* Oxford: Oxford U.P.
- Hersh, R. (ed.) 2006. *18 Unconventional Essays on the Nature of Mathematics*. New York: Springer.
- Hilbert, D. 1922. Neubegründung der Mathematik. Erste Mitteilung. *Abhandlungen aus dem mathematischen Seminar der Hamburgischen Universität* 1:157–177.
- Irvine, A.D. (ed.) 1990. *Physicalism in Mathematics*. New York: Springer.
- Kitcher, Ph. 1983. *The Nature of Mathematical Knowledge*. New York: Oxford U.P.
- Lakatos, I. 1976. *Proofs and Refutations: The Logic of Mathematical Discovery*. New York: Cambridge U.P.
- Lakoff, G., and R.E. Núñez. 2000. *Where Mathematics Comes From: How the Embodied Mind Brings Mathematics into Being*. New York: Basic Books.
- Latour, B. 2008. The Netz–Works of Greek deductions. *Social Studies of Science* 38(3):441–459.
- Livingston, E. 1986. *The Ethnomethodological Foundations of Mathematics*. London: Routledge.
- MacLane, S. 1986. *Mathematics, Form and Function*. New York: Springer-Verlag.
- Maddy, P. 1990. *Realism in Mathematics*. Oxford: Clarendon Press.
- Madrid Casado, C.M. 2011. Mathematical history of wave and matrix quantum mechanics. In *Fundamentals of Physics. Encyclopedia of Life Support Systems* (developed under the auspices of the UNESCO). United Kingdom: Eolss Publishers.
- Madrid Casado, C.M. 2014. *Hilbert et les bases des mathématiques*. Paris: RBA France.
- Madrid Casado, C.M. 2016. *The Butterfly and the Tornado. Chaos Theory and Climate Change*. London: National Geographic.
- Madrid Casado, C.M. 2018a. Brouwer. *Un geometra tra topología e filosofia*. Milano: RBA Italia.
- Madrid Casado, C.M. 2018b. *Filosofía de la Cosmología. Hombres, teoremas y leyes naturales*. Oviedo: Pentalfa.

- Mancosu, P. 2006. Visualization in logic and mathematics. In *Visualization, Explanation and Reasoning Styles in Mathematics*, ed. P. Mancosu et al., 13–30. The Netherlands: Springer.
- Mancosu, P. (ed.) 2008. *The Philosophy of Mathematical Practice*. Oxford: Oxford U.P.
- Manders, K. 1995. The euclidean diagram. In *Mancosu* (2008, 80–133).
- Manders, K. 2008. Diagram-based geometric practice. In *Mancosu* (2008, 65–79).
- Marquis, J.P. 2012. Mario Bunge’s philosophy of mathematics: An appraisal. *Science & Education* 21(10):1567–1594.
- Netz, R. 1999. *The Shaping of Deduction in Greek Mathematics. A Study in Cognitive History*. Cambridge: Cambridge U.P.
- Parsons, C. 1990. The structuralist view of mathematical objects. *Synthese* 84:303–346.
- Parsons, C. 2014. *Philosophy of Mathematics in the Twentieth Century*. Cambridge: Harvard U.P.
- Peirce, Ch.S. 1976. *The New Elements of Mathematics*, 4 vols. La Haya: Mouton.
- Peirce, Ch.S. 2010. *Philosophy of Mathematics. Selected Writings*. Indiana: Indiana U.P.
- Poincaré, H. 1902a. Review of Hilbert’s foundations of geometry [1899]. *Bulletin des Science Mathématiques* 26:249–272.
- Poincaré, H. 1902b. *La Science et l’Hypothèse*. Paris: Flammarion.
- Pólya, G. 1945. *How to Solve It: A New Aspect of Mathematical Method*. Princeton: Princeton U.P.
- Resnik, M. 1997. *Mathematics as a Science of Patterns*. Oxford: Clarendon Press.
- Romero, G.E. 2018. *Scientific Philosophy*. Switzerland: Springer.
- Rotman, B. 1988. Toward a semiotics of mathematics. *Semiotica* 72(1/2):1–35.
- Rotman, B. 1997. Thinking dia-grams: Mathematics, writing, and virtual reality. In *Mathematics, Science, and Postclassical Theory*, ed. B.H. Smith and A. Plotnitsky, 17–39. Durham: Duke U.P.
- Rotman, B. 2000. *Mathematics as Sign. Writing, Imagining, Counting*. Stanford: Stanford U.P.
- Schröder, E. 1873. *Lehrbuch der Arithmetik und Algebra*, vol. 1. Leipzig: B. G. Teubner [no further volumes published].
- Shapiro, S. 1997. *Philosophy of Mathematics: Structure and Ontology*. Oxford: Oxford U.P.
- Stillwell, J. 2010. *Mathematics and Its History*. New York: Springer.
- Szabó, L.E. 2003. Formal systems as physical objects: A physicalist account of mathematical truth. *International Studies in the Philosophy of Science* 17:117–125.
- Tegmark, M. 2008. The mathematical universe. *Foundations of Physics* 38:101–150.
- Thomae, J. 1898[1880]. *Elementare Theorie der analytischen Funktionen einer komplexen Veränderlichen*, 2nd edn. Halle: Nebert.
- Waismann, F. 1979. *Ludwig Wittgenstein and the Vienna Circle: Conversations*. Oxford: Basil Blackwell.
- Wigner, E.P. 1960. The unreasonable effectiveness of mathematics in the natural sciences. *Communications on Pure and Applied Mathematics* XIII:1–14.
- Wildberger, N.J. 2005. *Divine Proportions: Rational Trigonometry to Universal Geometry*. Sidney: Wild Egg Books.
- Wittgenstein, L. 1975. *Philosophical Remarks*. Oxford: Basil Blackwell.

Chapter 10

The Material Nature of Software



Miguel A. Quintanilla Fisac

*He doesn't help you think but he helps you because you have to think for him. A totally spiritual machine.
Umberto Eco, Foucault's Pendulum.*

Abstract Algorithms are sets of instructions (a type of declarative and operational statements in a language) to process sets of bits (minimal units of information) through the manipulation of sets of binary states of electronic devices. The secret of algorithms is that they are a mix of linguistic and electronic entities. Indeed, algorithm is another name for program or software in informatics technology. So, to answer the question “What are the algorithms made of?” we need to have a view of the very nature of computational content of a software statement. We will see that computational instructions in informatics technology are really instructions for manipulating physical signals loaded with information content. And we will see that this is just the same case we find in the philosophy of mathematics in general: the nature of algorithms is the same as the nature of mathematical entities.

10.1 Introduction

A computer algorithm is a set of instructions for processing accurate and comprehensively formulated information in a programming language. In current computer technology the term “algorithm” can be understood as an abstraction of the term “computer program”: the same algorithm can be implemented in different languages and give rise to different programs, executable on a computer, that meet the same objectives and perform equivalent calculation operations. Talking about “algorithms” allows us to deal with computer programming at a high level of

M. A. Quintanilla Fisac (✉)

University of Salamanca, Science and Technology Studies Institute, Salamanca, Spain
<https://maquinta.wordpress.com/>

© Springer Nature Switzerland AG 2022
G. E. Romero et al. (eds.), *Contemporary Materialism: Its Ontology and Epistemology*, Synthese Library 447,
https://doi.org/10.1007/978-3-030-89488-7_10

303

abstraction, and this has undeniable advantages. But it also has its drawbacks. The most important is that the widespread use of this term is often associated with ideological and inadequate representations of software, an essential component of all computer technology.

Indeed, the development of information technologies has created an ideal breeding ground for the proliferation of new versions of philosophical idealism, in their different variants. The world, again, is populated by two kinds of entities, hardware and software, matter and information, or simply matter and spirit. And the interpretation of this new technological reality is not always compatible with the thesis of a materialistic ontology. Popper's "third world" theory, for example, is not compatible with materialism (Quintanilla 1973). And it is doubtful that either Javier Echeverría's notion of third environment (Echeverría 1999), or structuralist realism of Floridi's information philosophy (Floridi 2011) are both materialism compatible.

Our reflections are in the conceptual framework of philosophical materialism and are intended as a contribution to the materialist, rationalist and critical ontology of information technologies. We believe that a correct formulation of the assumptions and ontological implications in this area can help in other, more practical tasks. For example, it can help to dismiss new spiritualist mythologies that pervert the perception of technologies by citizens and prevent them from assuming their own responsibility for supporting a model of technological development more in line with the interests of society as a whole (Quintanilla 2017).

We will deploy our argument in three parts. First we put forward a basic model of the ontology of technical systems that allows us to locate and understand the importance of information technologies for technological development in general. In the next section we explain the mathematical, physical and symbolic nature of the instructions that are part of algorithms and software of different levels. Finally, in the third section, we set out two examples which can help to understand the "creative capacity" of computer machines, from a point of view compatible with materialistic ontology. Our entire argument wants to be a tribute to the systemic materialism of M. Bunge which at an early date (1956) already proposed a materialistic vision of new electronic computing technology, and to the illustrated irony of Umberto Eco that taught us to see computers as "a totally spiritual machine".

10.2 A Systemic Approach to the Ontology of Technique

Most of the philosophers who deal with the ontology of technique take as the main reference of their reflections and analysis the notion of artefact (Franssen et al. 2018). An artefact is a material entity characterized by having a functional structure intentionally designed and produced. The problem is that, from this functionalist point of view, it is difficult to distinguish between artificial entities and some unintentional natural entities, especially of a biological nature, but also of a physical nature. A goat trail carved into the mountain as a result of the repeated passage of some animals along the same path is an artifact in the functionalist sense (the

creation of the path is explained because the repeated passage through the same site reduces the effort of new users and increases the likelihood that their number will grow). Even in the physical, non-biological world, there may be cases of functional structures that meet requirements similar to those of artifacts, although they are phenomena completely alien to any planning or design (the unintentional sedimentation of drag materials at the mouth of a river serves to create a delta with specific conditions more suitable for certain crops). Moreover, the functional description of an artifact is hopelessly ambiguous when it comes to distinguishing between its original own functions and overcome functions (Lawler 2007; Lawler and Vega 2009).

For these reasons we prefer to use as a reference for the ontology of technique the notion of technical system understood as a system of actions intentionally oriented to the transformation of concrete objects to efficiently achieve a result that is considered valuable (Quintanilla 2005). This definition results in some useful consequences, if an adequate ontology is available to characterize systems of actions. We use Bunge's systemic materialistic ontology (Bunge 1977), from which we can define the following notions (Quintanilla 1981, 1998, 2005):

1. A technical system $T = [C, S, E]$, is an action system, characterized by its composition C , its structure S and its environment E .
2. Components $C = [M, I]$ of a technical system may be intentional I or unintentional M . Unintentional components include raw materials, energy and technical equipment, or material parts, previously available, incorporated into the system. The intentional components include system operators or users.
3. The technical system structure $S = [W, K]$ is characterized by the W set of actions and transformation processes (work operations), and the K set of management or control actions of those processes, which consists of the normal operation of the system.
4. The environment $E = [O, R]$ of the technical system is the set of specific entities with which the technical system interacts, between which we distinguish two subsets: the subset O of entities whose transformation, manipulation, or control constitutes the intentional purpose of the system, and the subset R of entities whose transformation actually occurs as a result of the operation of the system.

An automatic washing machine can serve as an example of a technical system. Among the components of the system are the various parts of the machine (drum, motor, door, etc) including the clothes to be washed, the water and energy it consumes, the user who uses it, properly or not, and the automatic programming system etc. Among all these components we can distinguish the material components (clothing, water, energy, parts and mechanisms) and intentional (user, automatic washing program). In the structure we can distinguish two types of actions to be performed: "work" or execution actions necessary for the material transformation of system elements (load the washing machine, add detergent, dissolve stains from clothing, drain water spinning the load, etc), and control actions or management of the system status (to program the washing machine, to execute the program set of instructions, start operation, stop it, etc).

In general, two subsystems can be distinguished in any technical system: the execution (or working) subsystem of transformation actions and the subsystem of control or management actions. The first subsystem is based on the causality or determination relationships that exist between the system components and it includes all the material elements and agents that perform the work (changes of state) of the technical system. The second subsystem is based on design, planning, management and control relationships, and consists of entities, operations and information manipulation processes relevant to the operation of the system. The distinction between the two subsystems does not imply their complete separation. The actions taken to execute a task can be inseparable from those that are carried out to control that the task is accomplished: any manual tool requires not only the application of a force, but also the control of that application at the same time as it is executed (you cannot properly use a hammer without having enough force to move it and the ability to control the trajectory of your movement). Moreover, both the execution and control subsystems can have intentional and unintentional components: Savery or Newcomen's primitive steam engine required a manual operator to physically perform control operations by closing and opening taps that allowed the cylinder steam to cool or refill to start a new cycle. Years later, important innovations were introduced, such as the incorporation of a separate condenser from the main cylinder and a set of keys that were opened and closed automatically, including the centrifugal pressure regulator of the steam boiler invented by Watt in 1787. After these innovations, the steam engine's control subsystem was enlarged with new material elements, intentionally included in the machine design to increase its efficiency (Fig. 10.1).

The historical development of industrial technology seems to be governed by a kind of principle of innovation (new materials, new objectives, new technical systems, etc.) and of technical efficiency, definable and measurable in terms of the adjustment relationship between objectives intended O and results achieved R (Quintanilla 1993, 1998, 2005; Quintanilla and Lawler 2000).

These considerations are relevant for assessing the specific nature of computer technology. This is an automatic computing technology not just an information processing one. As historical precedents of computing technologies, we should see the abacus and the first mechanical calculation machine. Indeed, an abacus, as well as a mechanical calculator, is a tool to make and accumulate changes in the spatial position of various collections of beads, wheels or gears, which are operations of counting discrete amounts of things and representing them with numbers. And this is the essence of today's computer technology: manipulating physical states of several computer's digital electronic components, which represent arithmetic and logical values and operations.¹

¹ This vision of the physical and conceptual duality of computer programs appears in the pioneering article (Bunge 1956), sent by the author to the *BJPhS* in 1954, the same year Turing died, having launched his provocative thesis on the thinking of machines, four years before (Turing 1950).

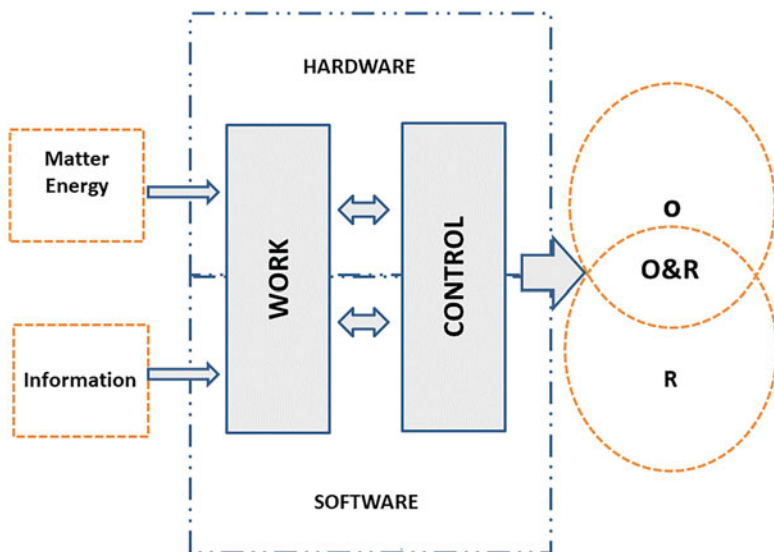

Fig. 10.1 Structure of technical systems. The distinction between hardware and software does not match that of execution subsystem (work) and control subsystem.. In both subsystems it may there be intentional and unintentional actions, and both types of actions may be replaced by computer devices with hardware and software components

The importance of computer technology lies neither in the nature of its components nor in the novelty of its operations, but in what Freeman (Freeman and Soete 1997) called the “pervasive” character of a technology: its ability to affect other technologies, improving its performance. In the case at hand, new information technologies represent a historic change: they are capable of affecting the intentional subsystem (tracking and control actions) of any other type of technical system. We do not need, for example, to design a new electromechanical device to incorporate it as a programmer into our automatic washing machines, it is sufficient that in the control system of the machine we incorporate a small microprocessor (or a complete computer, such as the Raspberry Pi), with a program designed explicitly for that task. The enormous penetration capacity of electronic computing technologies is due to that: it is not because algorithms have life of their own, but because we are filling every corner of our world with machines controlled by programming instructions. There is no computer revolution without microprocessor programming, just as there would have been no progress in calculus without tools like the abacus, the writing systems and the various number coding systems. The enormous penetration capacity of computer technologies in our society is not due to the ubiquitous, immaterial nature of software, but to the extraordinary capacity of today’s electronic technology to design and integrate information processing systems at ever smaller scales. One of the most notable features of actual electronically computing technology is represented by the so called “Moore’s law”, which predicts

the exponential growth of the density of electronic information processing elements (transistors) on the surface of integrated circuits.²

10.3 Algorithms, Programs and Electronic Circuits

Computers were initially perceived as an alternative to manual and mechanical instruments used to solve tedious numerical calculation tasks, necessary for military projectile interception operations or message coding and decoding. These early computer machines resulted in a new computer model, with some notable features:

1. They are machines to calculate (not for writing or transmitting information, although they also did these).
2. The new electromechanical machines incorporate into their structure a memory system in which all the information necessary for the calculation can be stored.
3. Both the data to be processed and the instructions (the program) to process them are stored in the memory of the machine.
4. The machine can read and execute the instructions of the stored program.
5. The program (the instructions recorded in the memory of the machine) can be changed without changing the rest of the machine structure, allowing for multiple technical systems with varied objectives and results.

These characteristics define the computer model with a stored program and its initial formulation is due to von Neumann (von Neumann 1945; Goldstine 1980), although the theoretical basis of the computer model is already present in the universal Turing machine (Turing 1937). The next decisive step in the evolution of information technology was the replacement of electromechanical and analogue electronic mechanisms with digital electronic mechanisms, thanks to advances in semiconductor physics, the invention of the transistor and the development of new techniques for the design and mass manufacture of integrated circuits.

Most signals that occur naturally or that incorporate relevant information of some kind are analogous. This means that the physical properties we use to produce or detect a signal vary continuously, within the limits of a range of values. Against this, a digital signal has only a finite set of possible discrete values, up to a minimum of two values, which is the widespread case in the treatment of electromagnetic signals in information technologies. The digital character of semiconductor electronics is responsible in addition to the imposition of a universal standard (bit: binary digit) in the representation and processing of information.

² The level of integration is reaching physical limits in the context of classical physics (nano-metric scale). But the next revolution will come from quantum computing, anticipated by R. Feynman (1982) which involves a new leap in the capacity and speed of calculation of new electronic components.

At this point we can list additional features of the digital technological revolution:

6. Digital computer systems are systems dedicated to automatic calculation with natural numbers.
7. Any natural number can be expressed on a binary basis.
8. Any numerical operation with natural numbers can be formulated in terms of Boolean logic and elementary arithmetic.
9. Any binary base numerical expression can be represented by the binary (On/Off) states of the components of a digital electronic circuit.
10. Any Boolean or binary-based arithmetic operation can be implemented by manipulating the state of the corresponding electronic circuits.
11. Any computable function of real numbers can be calculated with an arbitrary level of approximation if recursive algorithms can be executed and sufficient memory capacity is available.

After digitalization of computers, the paradigm of the computing technical system should be a personal computer. In its memory a set of algorithms that define the operations we expect it to perform has been installed, and it has also been equipped with peripherals that allow it to interact with the environment, as the source and destination of the information it processes.

When we talk about algorithms we refer to mathematical entities such as numbers, or digits, binary codes, etc. and abstract operations with these entities such as adding two numbers, comparing them, etc. An algorithm is a set of instructions to perform information processing operations. Instructions for correctly performing a sum, multiplication, or calculation of a square root are examples of simple algorithms for elementary arithmetic operations. A computer program is a set of expressions in a formal language, which represent an algorithm executable by a computer.

A computer program is a concrete embodiment of an algorithm, formulated in a formal language and executable by a digital computer machine. So in order to answer the question “What are the algorithms made of?” we will have to explain how computer programs work. And to do this we have to place them in the structure of electronic computing systems or current information technologies.

What we call a computer hardware consists of the physical components of the computer and the actions that are performed with them to modify their state so that the final state corresponds to the objectives for which we have run the system.

In the case of digital computers, the main components of the hardware are the CPU electronic circuits (Central Processing Unit) that are included in the microprocessor chip and are at least of these types:

1. **Registers:** electronic circuits (usually consisting of bi-stable circuits or *flip-flop*) that constitute the processor internal memory on which program instructions, data to be processed, and the results or changes into that data are recorded.
2. **Arithmetic-Logical Unit (ALU):** electronic circuits that perform arithmetic and logical operations with the information located at the registers.

Fig. 10.2 Transistors 'AND' gate

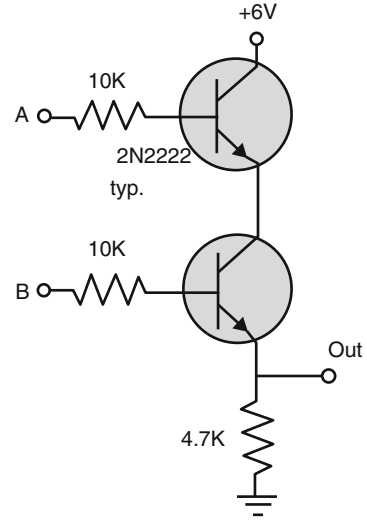

3. **Control unit**, including the clock used to synchronize the entire system, which executes instructions and manipulates data.
4. **Inbound and outbound electronic channels** to update memory registers and to communicate operations results.

All of these components are material components, electronic devices that are limited to change active state, open or closed, just as it could be done with an electric current switch panel. The type of operations that these machines can perform are limited to read and write the contents of the memory records and can only transform those values by elementary arithmetic and logical operations.

Suppose A and B are two positions of the computer's internal memory (can be CPU registers) that can be enabled ($A = 1, B = 1$) or disabled ($A = 0, B = 0$). A simple logical calculation operation would be the conjunction of A AND B and it would deliver the result of the operation to a third element of the internal memory, which we will call C . The operation is simple, and it has to answer to the table of conjunction in Boolean algebra (operation AND): $C = 1$ if and only if both $A = 1$ AND $B = 1$. Otherwise $C = 0$. There are many ways to implement an electric circuit that works according to instruction of the Boolean operation AND. For example the circuit in Fig. 10.2.³

If we also allow the CPU to perform hauling and bit recoding operations to form words (bytes) of different length, or use other encoding systems (decimal, hexadec-

³ I invite the reader to design an inverter circuit (such that when there is a high value at the input (1), there is one low in the output (0) and the other way around. And now remember that the Boolean NAND operator is just the inverse of AND, and that with NAND you can define any other Boolean operation.

imal, ASCII, etc.) we will have the full repertoire of binary value transformation operations that the machine is capable of performing.

Apart from these binary arithmetic operations the CPU performs many other operations, but they are all of the same nature: read the state in which a memory register is, manipulate the contents of the register according to the program instructions, store the result of the operation, read the following address, etc.⁴

The important thing about new computer technologies, understood as specific information processing technologies, is that they allow us to create fictional entities, with much greater capacity than the old technologies at the service of our literary or scientific writing abilities. In reality, the entire history of human culture could be rewritten as the story of our tools and machines for counting and calculating. The difference between the current computer revolution and previous stages of this technology is only quantitative: today's computer machines have an unmatched storage and information processing capacity compared to any previous technology. But the consequences of this huge growth of our computing capacity are extraordinary: it allows us to build numerical models of complex real processes and generate simulations of reality that we can use to evaluate our theoretical representations. To perform such operations computers only need to have sufficient storage capacity, processing speed and an appropriate program to calculate the values of the variables that define the model. And the procedure is always the same and very simple. On the one hand, any datum to be processed is transformed into a number. On the other hand, any number is treated in binary system as a representation of physical states of the microprocessor registers and computer memory. And finally, any algorithm to process the available information is a set of instructions in a formal language, created specifically to facilitate the manipulations of the binary states of the electronic components of the machine (Fig. 10.3). So ultimately *computer software is but a set of instructions in a formal language that the machine can receive and transform into physical processes of state-change that correspond to read/write/compute data on the microprocessor and machine memory*. The ability of computer technology to create a, so to speak, "virtual reality" is the result of the confluence of these factors:

- Any representation of any actual entity or process can be converted to information encoded in a numerical system.
- Any numerical encoding can be transformed into binary code.
- The state of the registers and memory of a digital electronic microprocessor can be represented by numeric symbol strings of binary code.
- Using the appropriate formal language, computer machine states (microprocessor and memory, input and output data interfaces) can be defined so that they change to the appropriate state according to the instructions received.

⁴ In the origins of personal computing, it was not so difficult to access personal computer manuals with detailed information on the microprocessor structure and programming instructions at the machine language level. A notable example is the ZX81 (Logan 1981).

	Information content	Information processing
Physical support (electromagnetic charges)	□◇□◇□□◇□	□□◇□◇□□◇
Binary code	01010010	00101001
Decimal code	82	41
ASCII code	R)

Fig. 10.3 Physical support and representation of information. The information to be processed is contained in the arrangement of electromagnetic charges present in electronic data storage devices. This information is represented by numbers in binary code, which can in turn be encoded in other codes, such as decimal or ASCII code that allows to transform numeric into alphabetical information. The right column represents what happens when the information is processed. In this case it is a minimal operation of moving the electromagnetic loads one position to the right, filling with zeros to the left. This means dividing the numeric value of the manipulated signal by two (from 82 to 41) or changing the alphabetic sign “R” to the parentheses “)”

- A computer algorithm or computer program is nothing more than a sequence of expressions and instructions, written in a high-level formal language (which facilitates the understanding of the meaning of expressions), which allows digitally encoded information to be transmitted to the computer’s processor (CPU).

We can set a hierarchy of programming levels, based on the semantic dependency between different levels of the language. What does this mean? A language L' depends semantically on another L language if the meaning of L' expressions can only be fully determined using L expressions. According to this, at least the following levels of programming languages could be distinguished.

1. **Level 0a: Machine language.** It consists of the binary encoding of instructions and data processed by the program. Each “program line” is a string of signals of 1 and 0 on a binary basis. And each binary string defines operations to be performed by the corresponding microprocessor. The meaning of machine language expressions is given by the structure, properties, and states of the machine. The semantics of the programming language are contained in the language itself, are machine-dependent, and include the physical description of the machine.
2. **Level 0b: machine language encoded** in decimal, hexadecimal, ASCII, etc. This is a transformation from language level 0 to a version of the machine language more easily manageable by the human brain, to perform or represent certain operations. This makes it easier to assign meaning to program instructions, but does not alter the semantic content of machine language expressions. The statement “MOVE to the AX register the contents of the XX memory

address” does not change its meaning because we express XX in binary or hexadecimal code.

3. **Nivel 1: Assembly language.** A small set of intelligible expressions that indicate the operations that the CPU should perform (such as, “read the contents of a register”, “sum the contents of two registers”, “move the contents of a memory address to a CPU register”, “fill a register with the result of an arithmetic operation”, etc.). The program has to be able to translate the algorithm (arithmetical operations) that you want to execute in terms of manipulation operations and data control by the CPU.
4. **Level 2a: High-level language compiled.** The language allows to program complex operations, such as instruction loops, subroutines, any kind of algorithms, in understandable terms for the programmer. But in order for a program to be executed by the hardware, it must first be fully compiled, that is, it must be translated into machine code (level 0 language).
5. **Level 2b: High-level language interpreted.** The language allows to formulate instructions that are directly understandable by the human programmer. An interpreter program encodes each instruction in machine code and executes them one by one, individually.
6. **Level 3: Object-oriented programming language.** In this case it is more of a programming style than a language type. It is about encapsulating programs into sets or classes of objects based on the tasks that can be performed with them and using those objects as the basic elements (constructive blocks) of the program to be executed. To determine the meaning of these algorithms, it is necessary to turn to the lower abstraction-level language, in which the properties of the objects we are using can be unfolded.

From the programmer’s point of view, the algorithm is a sequence of mathematical instructions, and the intellectual operation of programming a computer is of the same nature as computing a system of equations. The difference is that when using programming languages we use calculation routines specifically designed to be executed by the computer and whose full meaning depends on the structure and state of the machine. This task would be impossible if we did not have an essential type of programming languages (assemblers, compilers, and interpreters) that process program instructions formulated in a high-level language, to construct with them sequences of instructions to manipulate the physical state of the various machine registers.

This multi-level structure of programming languages, together with the pervasive nature of the information technologies we discussed above, is largely responsible for extending a dematerialized view of software. In fact, suppose we have a program (let’s call it OBJECT 1) that calculates the square root of a number, another program that allows building a right triangle from measurement data of two perpendicular straight segments in a plane (OBJECT 2). It is clear that we will be able to define a new program that will calculate the square root (OBJECT 1) of the hypotenuse defined by OBJECT 2. At this point we don’t need to know how the sides of the triangle have been measured or what computing operations we have performed

so that the microprocessor of our computer has calculated the square root of a number. We can completely determine the meaning of the expression “length of the hypotenuse c of a triangle with sides a , b ” without leaving our very high-level language, i.e. the common language broadened with names and definitions for certain elementary arithmetic operations. Beneath our chatter there are plenty of binary physical state manipulation operations of hundreds of thousands of electronic devices. But all this is hidden by the thick veil of our high-level language of abstraction: we are only calculating square roots and measuring lengths and angles on flat surfaces.

10.4 Creative Machines

Since the appearance of Turing’s famous article in *Mind* magazine (Turing 1950) much has been discussed about the possibility of creating truly intelligent machines, that is, capable of completely replacing the human brain in its highest and most complex functions. Over time, many of the forecasts and alarms thrown by philosophers have lost all their value. Today we know experimentally that a computer wins a game of chess to a human world champion. Doubts about the ability of machines to do typical things of intelligent humans have gone from being a philosophical speculation to a daily consumer commodity. Our small pocket computer, included in our mobile phones, with access to the large computing resources of the global communications network, allow us to talk to machines in natural language, ask them to read us a book, or to write to the dictation, identifying a human face or Today we know that computing machines are not the same think as people’s brains, but we cannot imagine any intelligent activity that we can formulate clearly without being sure that it will be possible to define an algorithm capable of taking on that challenge in a limited time. Computer machines cannot replace human brains in their normal functioning social context, but they can help humans by providing computing results on a scale unimaginable before the computer revolution, which pose new challenges for thought and action.

I will set out two cases in which I have personally participated and which can serve as an example of the creative capacity of computer machines. This is the MARIPOSA program and the Spanish Corpus of Science Culture.

The first case has to do with the contribution of computers to the creation of fractal-like images with two striking properties (Fig. 10.4). 1) First, the generated images have a peculiar aesthetic value, linked to what we might call the machine’s own “style” (Peitgen and Richter 1986): we can imitate the art of fractals, copying their results with other tools of drawing and painting, but the original will always carry the imprint of being the product of a computer machine (hardware + software). 2) The second feature is that you cannot foresee in advance what the final result will be of our machine programmed to generate fractal figures. The explanation of these characteristics of computer art is simple: these are programs involving parameters with random values and recursive processing routines, that is to say, of such a

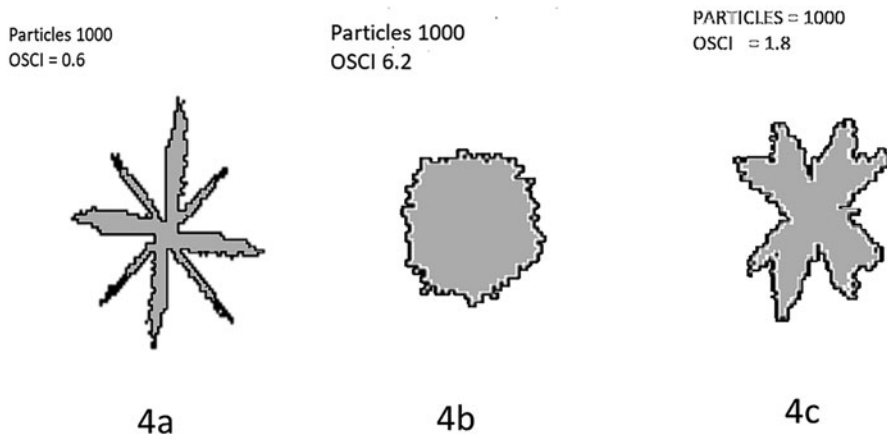

Fig. 10.4 Three images of particle diffusion, generated by the MARIPOSA program with different values of OSCI parameter, which defines, in radians, the angle of displacement for the particles trajectories

nature that the value of the function to be calculated at a given point can only be obtained after knowing the value of the same function in one previous step . In such circumstances it is even possible that a programming mistake may be responsible for the program giving an unforeseen but aesthetically valuable result.⁵ In that sense machines can be creative. And they are in fact. This is the case with the MARIPOSA program.

The initial idea emerged as a test to design processes of creation of fractal figures by particle concentration, following the reverse process to other programs that imitated the diffusion of particles (Sander 1987). These used a mechanism of random generation of particles from the edges of the figure, and diffusion to the center. My purpose was to see how the results varied if we reversed the direction of particles movement, generating them from the center of the figure and making their diffusion centrifuge, rather than centripetal. The box (Fig. 10.5) contains the MARIPOSA (BUTTERFLY in Spanish) program written in GWBASIC, with a black and white graphic interface. The logic of the program is very simple:

1. A new particle is generated (LINE 120) that begins to move from the center of the figure. When it reaches an empty position, the particle is “deposited” there (instruction PSET(X,Y) in LINE 210) and the process starts again from the central point with a new particle.
2. The particle begins to move in a randomly defined direction (ANGLE) modified by an OSCI parameter.

⁵ In the first version of this program, the function CINT (which rounds a fractional number to the nearest integer one) was used instead of INT (which takes the integer part of a fractional number).

```

10 '*****MARIPOSA/BUTTERFLY *****
20 '*****Miguel A. Quintanilla*****
30 SCREEN 2
40 CLS
50 DEFINT I,C,M,X,Y
70 INPUT "PARTICLES"; MAXNUMPAR
80 INPUT "DEVIATION (RADIANS)"; OSCI
90 COUNTER = 1
100 RANDOMIZE TIMER
110 WHILE COUNTER < MAXNUMPAR
120 X=100: Y=100
130 PSET(X,Y)
140 ANGLE=RND*6.28318
150 WHILE POINT(X,Y)>0
160 A$=INKEY$:IF LEN(A$)>0 THEN STOP
170 INCRE=INT(RND*OSCI)
180 X=COS(ANGLE+INCRE)+X
190 Y=SIN(ANGLE+INCRE)+Y
200 WEND
210 PSET(X,Y)
220 COUNTER=COUNTER+1
230 WEND
240 END

```

Fig. 10.5 MARIPOSA program in PCBASIC language, compatible with the version of GWBASIC originally used (1989). See Quintanilla (2003)

3. Depending on the value of the OSCI parameter, the aesthetic result varies radically. For OSCI values close to, or less than, 1 the result is an eight-pointed star-shaped figure. If OSCI has a value close to that of circumference (6.2 radians), the result simulates a fairly homogeneous oil stain. Finally for intermediate values, greater than 1.5, the configuration appears in the form of butterfly wings that give the program its name.

Such a simple program just shows part of the complexity of the images it generates that they are most vividly seen in polychrome versions.⁶ In fact it meets typical requirements of artificial intelligence products: it generates objects completely new, with objective specific properties, it does it in a completely “mechanical” way and it’s practically Impossible to achieve the same result without

⁶ In <https://maquinta.wordpress.com/aplicaciones/> you can see a polychrome version, more similar to the one originally published (Quintanilla 2003).

the use of the computation routines introduced by the program. As Umberto ECO points out: “computer doesn’t help you think but it helps you because you have to think for it”.

Another example of “creative” application of artificial intelligence techniques is found in the construction of the Spanish Corpus of Science Culture (SCSC).⁷ It is a corpus of more than fifty thousand articles published on the digital website of three Spanish newspapers during the years 2002 to 2011. To build it we had to process almost a million journalistic texts and apply various “creative” techniques of SVM (Support Vector Machine) algorithms (Joachims 2002; Vapnik 1995) capable of “discovering” structures and patterns in large data sets from a machine training sample consisting of 999 manually coded items.

Again, statistical analysis and massive data computing techniques allow us to discover trends, characteristic properties shared by subsets of data, etc. which constitute, in large part, the most valuable activity of human thought (Groves et al. 2015). But there is no mystery in the operation of these programs: the machine gives us in most cases the appropriate answer to the question we had asked. It only asks us for something in return: that we ask our questions in terms intelligible to it: that is, in terms of the description of states or changes of state in concrete things.

10.5 Conclusions About the Material Nature of Software

A vision of information technologies, in line with a materialistic and scientific philosophy, can be summarized in the following points:

1. Any technical system incorporates intentional elements that can be treated as information, i.e. conceptual objects whose configuration is relevant to determine the meaning of material operations that change and transform specific concrete objects.
2. Computer algorithms are sequences of data and instructions represented by the physical state and changes of state in the hardware.
3. Automatic calculation machines can help us create new ideas, images or concepts to represent complex aspects of reality or to invent new configurations of reality that can be valued with different criteria.
4. But information, such as ideas or words, does not inhabit a separate universe of intangible entities. Like other abstract entities, they may be objective and non-arbitrary conceptual fictions, but they do not exist as real material objects.

This materialistic interpretation of the nature of algorithms or computer programs, faces the same problems we traditionally encounter in the philosophy of knowledge and of mathematics about the nature of abstract entities. In particular, we think that our proposal is compatible with the fictional conceptualism

⁷ Free access to SCSC in <http://abejaruco.rec.usal.es/o> SCSC in <http://abejaruco.rec.usal.es/>.

proposed by Mario Bunge (2001: Ch. 6 and 13). Computer algorithms refer to states of things (ON/OFF) and to material entities (records, memory positions, etc.), but at the same time they represent entities and abstract properties that justify the transformations produced by computing operations. To do this, we do not need to assume that abstract entities have their own existence, apart from their concrete accomplishments. The expression “number 1” is nothing more than the name of the smallest set of all non-empty sets of numbers. So seen, number 1 is an abstraction, i.e. an entity invented by us and of which we pretend that it has its own existence. But in order to program a logical or arithmetic operation with the values of two memory positions of a computer (e.g. $1+1=2$) we do not need to assume that the result of that operation exists in a real world, we just need to verify that the operations defined by our program are compatible with the properties of the abstract entities to which the program instructions refer. For example: if we add two eight-bit records in which the binary coded value 00000001 is recorded, the result has to yield the value 00000010. If not, we will conclude that the interpretation of that operation as an arithmetic sum is erroneous and we will have to review our program to avoid the error. Abstract entities are fictitious not real, but they are objective, not arbitrary. Computer programs give material support to the manipulation and transformations of abstract entities, but they are not abstract, they are real material entities.

References

- Bunge, M. 1956. Do computers think? *The British Journal for the Philosophy of Science* 7(26):139–48.
- Bunge, M. 1977. *The Furniture of the World. Treatise on Basic Philosophy, Vol. 3*. Dordrecht: Kluwer.
- Bunge, M. 2001. *Scientific Realism. Selected Essays of Mario Bunge*, ed. M. Mahner. Prometheus Books.
- Echeverría, J. 1999. *Los Señores del Aire: Telépolis y el Tercer Entorno*. Barcelona: Destino.
- Feynman, R.P. 1982. Simulating physics with computers. *International Journal of Theoretical Physics* 21:467–488.
- Floridi, L. 2011. *The Philosophy of Information*. Oxford: Oxford University Press.
- Franssen, M., G.-J. Lokhorst, and I. van de Poel. 2018. Philosophy of technology. In *The Stanford Encyclopedia of Philosophy*, ed. Edward N. Zalta. Metaphysics Research Lab, Stanford University. Fall 2018. <https://plato.stanford.edu/archives/fall2018/entries/technology/>.
- Freeman, C., and L. Soete. 1997. *The Economics of Industrial Innovation*. London: Psychology Press.
- Goldstine, H.H. 1980. *The Computer from Pascal to von Neumann*. Cambridge: Princeton University Press.
- Groves, T., C.G. Figuerola, and M.A. Quintanilla. 2015. Ten years of science news: A longitudinal analysis of scientific culture in the Spanish digital press. *Public Understanding of Science* 25(6):691–705. <https://doi.org/10.1177/0963662515576864>.
- Joachims, T. 2002. *Learning to Classify Text Using Support Vector Machines – Methods, Theory and Algorithms*. Boston, MA: Kluwer Academic Publishers.
- Lawler, D. 2007. *Las Acciones Técnicas y sus Valores*. Salamanca: Ediciones Universidad de Salamanca.

- Lawler, D., and J. Vega. (eds). 2009. *La Respuesta a la Pregunta. Metafísica, Técnica y Valores*. Buenos Aires: Biblos.
- Logan, I. 1981. *Understanding your ZX81 ROM*. Melbourne: Melbourne Haus.
- Peitgen, H.O, and P.H. Richter. 1986. *The Beauty of Fractals*. Tokyo-Berlin-Heidelberg-New York: Springer Verlag.
- Quintanilla, M.A. 1973. Popper y Piaget: Dos Perspectivas para la Teoría de la Ciencia. *Teorema* 3(1):5–24.
- Quintanilla, M.A. 1981. A favor de la razón. Ensayos de filosofía moral. Madrid: Taurus.
- Quintanilla, M.A. 1993. The design and evaluation of technologies: Some conceptual issues. In *Philosophy of Technology in Spanish Speaking Countries*, 173–195. Dordrecht: Springer Netherlands.
- Quintanilla, M.A. 1998. Technical systems and technical progress: a conceptual framework. *Techné: Research in Philosophy and Technology* 4(1):72–79. <http://scholar.lib.vt.edu/ejournals/SPT/v4n1/QUINT.html>.
- Quintanilla, M.A. 2003. La Creatividad y las máquinas. In *Arte, cuerpo, tecnología*, ed. Hernández Sánchez, D., 119–36. Salamanca: Universidad de Salamanca.
- Quintanilla, M.A. 2005. *Tecnología: Un Enfoque Filosófico y Otros Ensayos de Filosofía de la Tecnología*. México: Fondo de Cultura Económica.
- Quintanilla, M.A. 2017. Engaging technologies: Criteria for an alternative model of technological development. In *Spanish Philosophy of Technology. Contemporary work from the Spanish Speaking Community*, ed. Laspra, B., and López Cerezo, J.A. *The Philosophy of Engineering and Technology Book Series*. New York-London: Springer.
- Quintanilla, M.A., and D. Lawler. 2000. El Concepto de Eficiencia Técnica. In *Tópicos Actuales en Filosofía de la Técnica. Homenaje a Mario Bunge en su 80 Aniversario*. Mar del Plata: Universidad Nacional Mar del Plata.
- Sander, L.M. 1987. Crecimiento Fractal. *Investigación y Ciencia* 126:66–78.
- Turing, A.M. 1937. On computable numbers, with an application to the entscheidungsproblem. *Proceedings of the London Mathematical Society* 2–42(1):230–65. <https://doi.org/10.1112/plms/s2--42.1.230>.
- Turing, A.M. 1950. Computing machinery and intelligence. *Mind* LIX(236):433–460. <https://doi.org/10.1093/mind/LIX.236.433>.
- Vapnik, V.N. 1995. *The Nature of Statistical Learning Theory*. New York: Springer Verlag.
- von Neumann, J. 1945. *First Draft of a Report on the EDVAC*. Moore School of Electrical Engineering, University of Pennsylvania. <https://sites.google.com/site/michaeldgodfrey/vonneumann/vnedvac.pdf?attredirects=0&d=1>.

Chapter 11

Mathematics Refer to Material Entities/Mathematics Do Not Refer to Material Entities



Gustavo E. Romero and Carlos M. Madrid Casado

Abstract This discussion is about whether mathematics refer to material entities or not. While both Carlos Madrid Casado and Gustavo E. Romero agree in their rejection of Platonism and radical conventionalism, Madrid argues that mathematics refer to the very material symbols they operate with while Romero states that they refer to abstract concepts fabricated by humans according to certain rules. The relationship between operational mathematical signs and diagrams and the mathematical concepts they outline deserves longer and more detailed case-by-case analyses, but the alternatives presented here encourage precise ways of formulating the question.

11.1 Mathematics Refer to Material Entities (by Carlos M. Madrid Casado)

Mathematics starts to organize itself into a scientific field in a way as empirical and real as that physics or chemistry: it does so around the physical or corporeal materials constituted by geometric, algebraic and logical signifiers. The difference between mathematics and other sciences is that mathematical signs are self-referential, that is, they refer to themselves, to their mentions as graphical entities. In contrast, natural sciences use signs whose reference is externally associated with them. We can only understand the chemical meaning of the reaction $H_2 + I_2 \rightarrow 2HI$

G. E. Romero (✉)

Instituto Argentino de Radioastronomía (IAR) (CONICET; CICPBA; UNLP), Villa Elisa, Buenos Aires, Argentina

Facultad de Ciencias Astronómicas y Geofísicas, Universidad Nacional de La Plata, La Plata, Provincia de Buenos Aires, Argentina

C. M. Madrid Casado

Fundación Gustavo Bueno, Asturias, Spain

e-mail: cmadrid@fgbueno.es

© Springer Nature Switzerland AG 2022

G. E. Romero et al. (eds.), *Contemporary Materialism:*

Its Ontology and Epistemology, Synthese Library 447,

https://doi.org/10.1007/978-3-030-89488-7_11

when we accept that H_2 , I_2 and HI refer to something outside the typographical plane (to hydrogen, iodine and hydrogen iodide). But we do not need to go beyond the plane of the literals to understand the mathematical meaning of the algebraic expression $(a+b)^2 = a^2 + b^2 + 2ab$: $2ab$ refers to the pair of mentions of the monomial ab resulting from the application of the distributive and commutative properties. Only mathematics (and logic) operates immanently with signs, leaving out any reference that is not transferable to the plane of the paper or the blackboard.

Traditional candidates for references of mathematical signs have been existing ideas in some Platonic world or, alternatively, abstract concepts that are a product of the human mind. From the point of view of *formalist materialism*, signifiers themselves are the reference of mathematical signs.

However, this does not mean that mathematics is reduced to a system of meaningless and empty inscriptions. Mathematical signs consist of signified. What happens is that the signified of the mathematical signs (i.e. the mathematical concepts) arises in the context of the operations of the mathematician with the referent-signifier. The concept-signified is formed through the manipulation of the signifiers. This is why you cannot teach mathematics without doing mathematics.

A musician needs sonorous materials, technical instruments and musical notes in order to compose music. Mathematicians need graphical signs, instruments (chalk, pencil, computer) and concepts in order to compose mathematics. The three components are necessary. Mathematicians do not compose mathematics with only one or two of these elements. But the conceptual plane must be articulated with the typographical plane, preserving the primacy of the typographical materiality plane, which is the starting point of mathematics. Mathematics is primarily a sort of written language that is subsequently spoken, rather than a spoken language that has been written down.

Only from those glyphs drawn on paper or blackboard, which we call *ideograms*, can mathematicians handle mathematical concepts and determine the relationships that lead to theorems. A demonstration or a proof is a concretely visible argument. It succeeds by showing or displaying a sequence of geometric or algebraic ideograms. As I discuss more at length in my chapter in this book, we find ideograms throughout the history of mathematics, from primitive arithmetic and Greek geometry to modern topology, through algebra and analysis. The ideograms give existence to mathematical objects as abstract as Hilbert cube or Klein bottle, which involve infinity and multiple dimensions. Another illustration is provided by the elusive complex numbers.

Complex numbers started taking shape when Rafael Bombelli (1526–1572) showed by skillful algebraic manipulations the usefulness of certain ideograms containing square roots of negative numbers in order to find the solution of geometric problems. He was trying to find the solutions of the cubic equation $x^3 = 3px + 2q$, where p and q are real parameters. Because the algebraic ideograms were still a function of previous geometric ideograms, this algebraic problem was seen as a geometric problem: finding the cut-off points of the cubic $y = x^3$ with the line $y = 3px + 2q$. In the *Ars magna* (1545), Gerolamo Cardano determined the

solutions as follows:

$$x = \sqrt[3]{q + \sqrt{q^2 - p^3}} + \sqrt[3]{q - \sqrt{q^2 - p^3}} \quad (11.1)$$

For example, in the case where $p = q = 1$, the equation to be solved is $x^3 = 3x + 2$ and the Cardano–Tartaglia–del Ferro formula provides us with the solution $x = \sqrt[3]{1} + \sqrt[3]{1} = 2$. But if $q^2 < p^3$, the square root of a negative number had to be found, which seemed conceptually impossible.

Despite this, Bombelli manipulated the ideogram (11.1), managing to obtain real solutions for the geometric problem and, incidentally, the first conceptualization of complex numbers. This first conceptualization arose precisely through its operations with signifiers—the square roots of negative numbers—which in principle did not refer to anything other than their own typographical mentions in the context of solving the problem. Indeed, for $p = 5$ and $q = 2$, $\sqrt{(q^2 - p^3)} = 11\sqrt{-1}$ (which was paradoxical) and the solution was:

$$x = \sqrt[3]{2 + 11\sqrt{-1}} + \sqrt[3]{2 - 11\sqrt{-1}} \quad (11.2)$$

Through an ingenious manipulation of the signifiers, Bombelli observed that $(2 \pm \sqrt{-1})^3 = 2 \pm 11\sqrt{-1}$, so substituting in (11.2):

$$x = 2 + \sqrt{-1} + 2 - \sqrt{-1} = 4 \quad (11.3)$$

Therefore, the real solution was $x = 4$, and to find it, it was essential to consider in the Cardano formula the complex numbers $2 \pm 11i$ (using the ideogram subsequently coined by Euler for the imaginary unit). One more example of how mathematical concepts emerge from *praxis* with ideograms has to do with the identification of a^0 with 1. The power a^0 is not a sign that refers to a concept whose description would be “a multiplied by itself zero times”, because this expression means nothing at all. The power a^0 is a self-referential sign, which refers to its mentions, and whose meaning appears in the handling of ideograms, when these two chains of signifiers are identified:

$$\frac{a^n}{a^n} = a^{n-n} = a^0 \quad \text{and} \quad \frac{a^n}{a^n} = 1$$

In fact, *algebraist* meant etymologically “he who manipulates bones” (thus appeared in *Don Quixote*), and this meaning gradually evolved until it became “he who manipulates algebraic expressions, such as the x of an equation.”

To summarize, typographical signs written in ink on paper or with chalk on the blackboard are the *physicalist* (corporeal) terms of mathematics. According to the references of its field, mathematics is a science of typographical materialities. There are no *formal* sciences, that is, sciences studying pure and immaterial forms (be they

logical or mathematical) as if they were ideal sciences that only deal mentally with concepts. The so-called formal sciences are, in fact, *material* sciences, because their construction requires mathematicians to perform operations with physical referents, such as logical or mathematical glyphs. All science is constructed by operating on a field of physical objects, so it is impossible for a science to be constructed by operating exclusively with concepts or ideas. In the case of mathematics, those tangible objects are *ideograms*. Let us conclude by quoting George Berkeley (1967[1708], 767): “Take away the signs from Arithmetic and Algebra, and pray what remains?”

11.2 Mathematics Do Not Refer to Material Entities (by Gustavo E. Romero)

The theories we use to represent the world can be exceedingly complex. They deal with such things as electrons, fields, neutron stars, dark matter, neural networks, economic markets, the atmosphere, and many other entities that we assume there exist in the universe. In formulating our theories we appeal to exact languages that allow us to minimize vagueness and express ourselves as precisely and quantitatively as possible. We resort to mathematics. And when our factual theories are formulated in mathematical language, they refer not only to objects that we think are material, such as particles or people, but also to more strange entities that belong to an abstract realm: sets, numbers, functions, algebraic spaces, manifolds, topologies, and other things of the kind. These objects are not material in the sense we say that an apple is material. They do not exist in spacetime, they do not interact, they do not change or evolve. Nevertheless, there they are, deeply embedded in our most cherished theories about the world. What is their ontological status?

A nominalist would say that these entities do not exist at all. That mathematical objects are dispensable and talk about them can be translated into a discourse whose ultimate referents are concrete, material entities. Attempts in this direction have been tried, in current philosophy, since Goodman and Quine (1947) until Field (1980) and beyond (see Burgess and Rosen 1997). According to this view, mathematics do not refer at all. At least, mathematics do not refer to anything beyond the material world. This program has not succeeded: elements as basic as sets seem to be indispensable to mathematics. Attempts at eliminating all reference to abstract entities in complex mathematical structures have encountered insurmountable difficulties (e.g. Quine 1960).

Platonists, on the other hand, take mathematics at face value: if mathematical theories refer to abstract entities, and these theories are true, then these entities should exist somehow. Certainly, these Platonic entities are not material in the sense that a chair is material, but nevertheless they should exist in some way, independently of the human mind. They must have an autonomous reality. The world is not purely material for the Platonist.

I think that in their current forms these views rest on a misunderstanding of the role of logical quantification. Current formal languages adopt an existence operator ‘ \exists ’ that acts as a particularizator for variables. Since Quine (1948) it has been popular to think that the existential quantifier exhausts the concept of existence in such a way that the only objects whose existence should be admitted in our ontology are those accepted in the domain of ‘ \exists ’.

Logical quantification, however, only establishes a correspondence between individuation and formal coherence:

$$\exists x f(x) \leftrightarrow \{x / f(x)\} \neq \emptyset,$$

where $\emptyset = \{x / x \neq x\}$ is the empty class. Formal existence, hence, signifies nothing more than freedom from contradiction. Empirical science and natural language, however, adopt other senses of ‘existence’. We can quantify variables that range over numbers, unicorns, electrons, planets, wave-functions, Don Quixote, and many other objects that require additional intensional specification if we want to speak meaningfully about them. We can attain this introducing a predicate indicating a *mode of existence*.

Pure formal existence points out just coherence within an organized and consistent system of statements; the expression of ontological existence, instead, requires both formal existence and a predicate expressing the intended mode of existence.

How many modes of existence there are is a matter of fact. I propose only three modes: material, formal, and fictional existence. Something exists materially if, and only if, it has energy (i.e. if it is capable of change). Something exists formally if, and only if, it is a part of a well-defined formal system. Last, something exists fictionally, if it is characterized in some context that is not formal, e.g. by isolated definitions or descriptions. In this way, we can say that a given electron exists materially, Hilbert spaces exist formally in functional analysis, and Don Quixote exists fictionally in Cervantes’ novel. Both formal and fictional existence are forms of *conceptual existence*, i.e. products of cognitive activities of concrete beings.

In particular, mathematical objects are *conceptual artifacts*: inventions of the human mind created according to explicit formation rules. In a broad sense, they are all *fictions* (see Romero 2018a and Bueno 2009).

Essentially, mathematical objects are ontologically on a par with artistic and mythological creations (see Romero 2018b); the difference is contextual: mathematical objects are introduced through theories that are both formal and consistent (in the sense that they do not include contradictions), whereas artistic and mythological fictions are presented in an informal way through novels, narratives, movies, stories, legends, and so on.

There are also differences in the intentional attitudes that correspond to the positing acts of mathematical objects and artistic or mythological fictions. Mathematical entities are posited as a part of a mathematical theory. Once we grasp their formation rules in the context of that theory, we can infer or even intuit some properties of the object. Many mathematical entities, however, are far too complex to have a mere intuition of them and we have to stick to the formation rules to get further insights

(think, for instance, of transfinite numbers, Hilbert spaces, and abstract algebras). In the case of fictional characters and other fictions, all insight depends upon the information given to us by the primary source. We cannot know whether Don Quixote is thin or not if Cervantes has not informed us about whether he attributed this feature to him or not. On the contrary, if we master the formation rules of some mathematical system we can infer various features of the objects to which the system refers. This shows that the form of cognitive access we have to both kind of objects is quite different. In one case we fully depend on the intentional attribution of the various features by a creative subject, in the other we should follow specific rules in order to find the attributes.

I define a mathematical object as follows:

An object x of a consistent formal system M is a conceptual artifact if, and only if, there is a set C such that $x \in C$ and C is specified in M .

The specification is implemented through some of the axioms of M . The semantic rules in M relate symbols in the system to conceptual artifacts. A statement in M about a certain conceptual artifact is true if, and only if, the statement is derivable in the system. Mathematical statements, then, are true in a system if, and only if, they can be proved in such system.

Despite of being human creations, mathematical objects are not arbitrary or purely subjective. Mathematical objects are bound by the axioms of the mathematical theories that introduce them. Anyone who masters these theories can attain knowledge of these conceptual objects. In complex theories, not all implications of the axioms can be initially discerned. Hence, research of mathematical systems is necessary to elucidate the relevant consequences of the fundamental postulates. The mathematician not only invents new formal systems, but mainly looks for the implications of already proposed theories. In doing so, the researcher appeals to both invention and discovery. Invention of original ways of establishing a proof and discovery of unforeseen implications of some axioms.

Ultimately, mathematical objects do not refer to material entities if they are not interpreted in factual theories. As all fictional objects, mathematical objects arise from stipulations and statements that involve them in mathematical theories that are made true by further stipulations. This is essentially Hilbert's view of mathematics. For Hilbert any consistent stipulation of a mathematical entity produces that entity.

Since truths about mathematical artifacts depend always on the corresponding formal contexts where the artifacts are defined, mathematical truths are analytical and independent of the world (although mathematical statements are not tautologies as once thought by Wittgenstein and followers). If we introduce a model operator T^M as a short of "it is true in the system M that" we can state, for instance:

$$\exists x T^M(\dots x \dots). \quad (11.4)$$

If M is the theory of integer numbers, an instance of this might be "it is true that there exists an integer number smaller than 4 and greater than 2". But this does not imply that there is a material object called "3". Statement (11.4) is true in M , not in the world.

If mathematical objects are conceptual fictions, why then they can be applied to describe real objects and processes in the material world? The answer is precisely because pure mathematics is ontologically neutral and then mathematical ideas are portable across research fields and can be used to exactify our ideas about the factual world. In some contexts, mathematical theories can be extremely useful. For instance, if we are interested in capturing certain structural properties of empirical phenomena—such as the representation of their dynamical state or radiative properties—the mathematical apparatus offers a rich, precise and versatile framework. In other contexts, however, mathematical theories are far from useful. For instance, suppose that we are interested in capturing the psychological states of some animals under stress; in this case, it's unclear whether, in general, the use of mathematical vocabulary is of much relevance. There is not an a priori way to determine whether a given mathematical theory will be useful or not to factual science, and this is because we do not know how the universe is. The richer our mathematical theories are, the stronger is our capability of representing reality. Basic research in mathematics, therefore, should be encouraged if we want to expand our expressive capacities to discuss and describe the world in its wide complexity. It is not that we apply mathematics to reality, but rather that we can make our ideas about reality more exact through their mathematization. An exact language based on mathematics has a greater expressive power to describe with precision the world than a mere natural language, which is infected with vagueness and imprecision. The world is not mathematical, but our ideas about it can be expressed, felicitously, through mathematics.

Summing Up Although some of our most primitive mathematical theories might have been inspired by observations of empirical phenomena, mathematics are a free creation of the human mind with no independent existence. Mathematical entities are conceptual artifacts formulated within the framework of consistent theories through stipulations. Mathematical truths are analytical and can be established only in the context of the theories that contain the constitutive stipulations of the formation of mathematical objects. Mathematics do not refer to material entities. Mathematics refer to well-defined fictions.

11.3 Response to Gustavo E. Romero (by Carlos M. Madrid Casado)

Gustavo E. Romero puts forward a cogent philosophy of mathematics, which follows Mario Bunge's (1985) footsteps. I would argue, however, that his proposal adopts a foundational rather than a historical approach. Indeed, Romero claims that mathematical objects are conceptual artifacts created by human beings in the context of formal languages. They are bound by the axioms of the theories that introduce them, and these theories are both formal and consistent. But does this view of mathematics cover sufficiently what we historically refer to as mathematics?

Formalized mathematics only emerged in relatively recent times, not before the twentieth century. Hence, a view of mathematics as a system of consistent formal theories would need to exclude the works of Gauss, Euler, Leibniz and Archimedes, because they were not doing mathematics on that view. This would tantamount to falling into the anachronism of projecting the view of doing mathematics inherent to the twentieth century to the entire discipline. Mathematically, it is not only the formalized that exists. Were this so, natural and real numbers would only exist mathematically as from Peano's and Hilbert's works respectively, who endeavoured to reconstruct those objects axiomatically.

Moreover, one should not underestimate the ways working mathematicians of the present time practice their science. For Field's medal winner William Thurston (1994), for instance, mathematics is not simply practiced according to the model of the definition–theorem–proof within formal languages. Rather, it involves natural and bodily language, diagrams, visualizations, computers, and other non-formal devices. Mathematical proofs themselves are often semiformal, and do not usually take the shape of a derivation from the axioms of a formal system. To describe mathematics as presupposing an axiomatic formal theory suggests more organization than what actually appears.

Other criticism that can be raised against Romero's foundational approach is that it may carry the implicit admission that it is possible to (i) redefine all mathematical objects as formal sets and (ii) reconstruct the diverse branches of mathematics as consistent formal theories. Thus, Romero defines a mathematical object as a conceptual artifact, i.e. as an object x of a consistent formal system M such that there is a set C such that C is specified in M and $x \in C$. For Romero, as for Bunge (1985), a mathematical construct exists if there is a set that contains it and if it can be specified by means of a consistent formal theory. However, as Marquis (2012, 2019) objects to Bunge, that all mathematics can be reduced to set theory is a *desideratum* rather than a descriptive proposition. Which formal set is, for example, the monster group or the Lorenz attractor? And what about mathematical objects that do not belong to any set, such as the class of all sets, the Russell class and other cofinal classes with the universe V of sets? Romero (2018a, 94) claims that the set of all sets is not a conceptual artifact, and therefore not a proper mathematical object. But this class is introduced into NBG theory.

Furthermore, for Romero (2018a, 95) “conceptual artifacts, and therefore mathematical objects, can be introduced *only* through their characterization in *consistent* formal theories.” But this postulate carries serious technical problems. A consistent formal theory is one that does not entail a contradiction. At the beginning of the last century Hilbert called for a formalization and axiomatization of mathematics, together with a proof of its consistency (Madrid Casado 2014). Hilbert's program was driven by the goal of providing a consistency proof that was to be carried using only finitary methods. Hilbert himself proved that the consistency of geometry is reduced to the consistency of analysis. Moreover, he provided an axiomatization of analysis as second-order arithmetic. He then realized the necessity of obtaining a direct consistency proof of arithmetic—i.e. one not based on reduction to another formal theory. As is well known, however, Gödel's second incompleteness theorem

showed that formal theories that can express a fragment of arithmetic sufficiently strong (such as Peano arithmetic and ZFC set theory) cannot prove their own consistency.

After that, Gentzen reduced the consistency of Peano arithmetic (first-order arithmetic) to that of a formal theory augmented with transfinite induction. But this notion of consistency is weaker than the one Hilbert was after, because Hilbert had asked for a finitary proof and Gentzen extended the finitary standpoint to prove the consistency relative to stronger formal theories. Nowadays there is only a relative consistency proof of analysis (second-order arithmetic) by reducing its consistency to the consistency of a formal system with bar recursion (a scheme for constructing objects by transfinite recursions).

In sum, Gödel's theorems showed that there can be no absolute consistency proof of mathematics as a whole. Of course, Romero (2018a, 93) is well aware that mathematicians cannot ultimately prove the consistency of most of their theories. But then, according to his postulate, should it be concluded that we simply cannot know whether, at the end of the day, mathematical objects exist?

From an epistemological point of view, the fictionalist account of mathematical objects as conceptual artifacts is difficult to reconcile with the notational aspects of mathematical knowledge. For this kind of fictionalism, mathematical ideograms are something secondary, a mere pedagogical support, which does not explain the importance of signs and diagrams in mathematics: five, V and 5 mean the same concept, but the Indo–Arabic number presents a computational power lacking in the word or Roman numeral. As Serfati (2010) pointed out, symbolic writing is a powerful tool for creating mathematical objects. For example, in early modern mathematics, the ideogram 3^7 could be described by “multiply the number three seven times by itself.” But which conceptual meaning could be associated to the ideogram $3^{\frac{1}{2}}$? Clearly not “multiply the number three half-time by itself.” Fractional exponents were nonsense. These ideograms without pre-given significance acquired their signified by means of algebraic substitutions. If $(a^m)^n = a^{mn}$, then $(a^{\frac{1}{2}})^2 = a^{\frac{1}{2} \cdot 2} = a^1 = a$. And therefore the only possible value for $a^{\frac{1}{2}}$ was \sqrt{a} , as Newton pointed out to Leibniz in a letter in June 1676. These physical manipulations provided signified to an ideogram which did not have any.

Another example is complex numbers. What ended up giving complex numbers existence was not a consistency proof but the connection of their algebraic ideograms with unanimously accepted geometric ideograms (when Argand and Gauss represented them on the plane, visualizing the imaginary unit i as a *lateral unit*).

The materials—the physicality of pencils, sheets, chalks, blackboards, and glyphs—matter in mathematics. As Barany and MacKenzie (2014) defend, no mathematical result can be accepted if there is no clear way to write it. The rigor at the heart of mathematical development is inseparable from the technology of writing, that is, from the “chalk in hand.” Mathematical thinking goes with mathematical writing, and conversely.

Lastly, another objection that can be made to the conceptualist or fictionalist view is the following: it is a fact that computers solve mathematical problems. Should we accept then that they handling conceptual artifacts or that they *think*? On my account, a computer is not some sort of mysterious brain, but rather an operator, a machine that manipulates signifiers and that is therefore capable of doing mathematics.

These points of divergence between Romero's vision of mathematics and my own should not hide that we both share a common thesis: the rejection of radical conventionalism and of Platonism. Both our views are materialist in that they claim that mathematical objects have no independent existence and that the world is not mathematical at all. If human species were to disappear and all ideograms were to disappear too, mathematics would cease to be.

11.4 Response to Carlos M. Madrid Casado (by Gustavo E. Romero)

In his note "Mathematics refer to material entities" Carlos Madrid defends a position he calls *formalist materialism*. This is the doctrine, to say it in simple terms, that mathematical symbols refer only to themselves. In his words: "mathematical signs are self-referential, that is, they refer to themselves, to their mentions as graphical entities".

I think that Carlos and I agree on several issues. First, we agree upon the nonexistence of a Platonic realm of pure ideas or immaterial objects. We both think that there is a sense in which the statement 'the only existents are material entities' is true. Second, we both agree with David Hilbert upon that mathematics is a formal language. And we finally agree on thinking that mathematics actually *refer*. We differ, I think, upon what the referents of mathematics are. For Carlos Madrid mathematical signs refer to *ideograms*, i.e. "glyphs drawn on paper or blackboard". I, instead, think that mathematical symbols *designate* mathematical objects that are well-defined (and sometimes quite complex) *conceptual artifacts*, i.e. carefully defined *fictions*.

I understand that there are strong reasons to reject Carlos's position. I mention the following ones.

- It is not true that "A demonstration or a proof is a concretely visible argument. It succeeds by showing or displaying a sequence of geometric or algebraic ideograms." Many proofs are purely conceptual because they involve either an infinite number of steps or a proof by contradiction where the referent is never explicitly shown, but its conceptual existence is established.
- Gödel's incompleteness theorems are valid for all sufficiently strong but consistent recursively axiomatizable theories. Together, they entail that an inscriptionalist program fails. It turns out that higher mathematics cannot be interpreted as a consistent string of ideograms. Higher mathematics can prove arithmetical

sentences, such as consistency statements, that are beyond the reach of Peano Arithmetic.

- Mathematics and logic are not different from the point of view of the formalist materialism advocated by Carlos Madrid. Nevertheless, mathematical symbols have a semantic dimension that goes well beyond than self-reference to inscriptions and other tokens. Whereas logic can be understood as pure formal syntax, mathematical constructs have an associated meaning consisting not only of reference, but also of *intension*. Different symbols, such as ‘ \emptyset ’ and ‘ $\{ \}$ ’, have identical meaning because they share *both* reference and intension. What matters is the concept we assign to the symbol and its relation to other concepts in the same system, not the inscription we use to draw the symbol that designates the concept. There is no rich semantics associated with self-reference alone (see Romero 2018a, chapters 2 and 7).
- Since Carlos Madrid rejects the idea that mathematics refer to concepts, Frege’s criticism of Heine’s formalism is in order: formalist materialism cannot account for infinite sequences. Mathematics, then, results severely mutilated.
- Let us consider the following two expressions: $\phi : \mathfrak{N}^4 \longrightarrow \mathfrak{R}$ and $\theta : R^4 \longrightarrow R$. Any reader trained in elementary math will realize that both expressions refer to the same object: A class of functions that apply a real 4-dimensional manifold to the set of real numbers (i.e. both inscriptions refer to the same concept). A formal materialist, instead, should declared that the different expressions refer to different material objects (their respective and different inscriptions). Small typographical differences become unsurmountable obstacles.
- Mathematical concepts have different properties than the physical inscriptions that we use to designate them. For instance, $\Gamma(z) = \int_0^\infty x^{z-1} e^{-x} dx$, $\mathfrak{R}(z) > 0$ is the so-called Gamma function, whose properties, arguably, are different from the physical properties of the corresponding material inscription that represents it.

I think that such an extreme position as inscriptionalism originates in excessive scruples adopted to avoid commitments with an immaterial ontology. I think that there is no reason to fear here. We can use mathematical concepts freely of any ontological commitments if we accept that such concepts are inventions of our own, given in an exact language. When we talk about Don Quixote we do not mean just an inscription that is self-referent but we name to a noble from La Mancha named Alonso Quijano, who reads so many chivalric romances that he loses his mind and decides to become a knight-errant through the lands of Castilla. Of course, if someone asks whether Alonso Quijano was a real person, we will answer that of course not: he is a fictional character in Cervantes’ famous novel. In a similar way, when we write, for instance, \aleph_0 we mean not ‘ \aleph_0 ’ but the cardinality of natural numbers, and we can mention many properties of \aleph_0 . We can do this because the symbol ‘ \aleph_0 ’ refers to a concept, and this concept has well-defined properties that are

not the properties of the physical inscription. Do we think \aleph_0 exists? Not really; we think that it just exists as a fiction in one of our conceptual mathematical theories.¹

Summing Up We do not need to relinquish mathematical concepts in order to stay full materialists. We can keep them in our languages without including them in our ontologies, just treating them as what they are: fictions, things of our imagination.

References

- Barany, M., and D. MacKenzie. 2014. Chalk: Materials and concepts in mathematics research. In *Representation in Scientific Practice Revisited*, ed. C. Coopmans, M. Lynch, J. Vertesi, and S. Woolgar, 107–129. Massachusetts: MIT Press.
- Berkeley, G. 1967[1708]. Philosophical commentaries. In *Works*, vol. I, ed. A.A. Luce and T.E. Jessop, London: Nelson.
- Bueno, O. 2009. Mathematical fictionalism. In *New Waves in Philosophy of Mathematics*, ed. O. Bueno and O. Linnebo, 59–79. Basingstoke: Palgrave Macmillan.
- Bunge, M. 1985. *Treatise on Basic Philosophy. Vol. 7. Epistemology and Methodology III: Philosophy of Science and Technology. Part I: Formal and Physical Sciences*. Holland: Kluwer.
- Burgess, J., and G. Rosen. 1997. *A Subject with No Object: Strategies for Nominalistic Interpretation of Mathematics*. Oxford: Clarendon Press.
- Field, H. 1980. *Science without Numbers: A Defense of Nominalism*. Princeton, NJ: Princeton University Press.
- Goodman, N., and W.V. Quine. 1947. Steps toward a constructive nominalism. *Journal of Symbolic Logic* 12:105–122.
- Madrid Casado, C.M. 2014. *Hilbert et les bases des mathématiques*. Paris: RBA France.
- Marquis, J.P. 2012. Mario Bunge's philosophy of mathematics: An appraisal. *Science & Education* 21(10):1567–1594.
- Marquis, J.P. 2019. Bunge's mathematical structuralism is not a fiction. In *Mario Bunge: A Centenary Festschrift*, ed. M.R. Matthews, 587–608. New York: Springer.
- Quine, W.V. 1948. On what there is. *From a Logical Point of View* (rev. 2nd ed. 1961), 1–19. New York: Harper Torchbooks.
- Quine, W.V. 1960. *Word and Object*. Cambridge, MA: MIT Press.
- Romero, G.E. 2018a. *Scientific Philosophy*. Cham, Switzerland: Springer.
- Romero, G.E. 2018b. Outline of a theory of scientific aesthetics. *Foundations of Science* 23:795–807.
- Serfati, M. 2010. Symbolic revolution, scientific revolution: mathematical and philosophical aspects. In *Philosophical Aspects of Symbolic Reasoning in Early Modern Mathematics*, ed. A. Heffer and M. van Dick, 103–122. London: King College.
- Thurston, W.P. 1994. On proof and progress in mathematics. *Bulletin of the American Mathematical Society* 30(2):161–177.

¹ I remind the reader here the distinction I introduced earlier in this chapter of different forms of existence. The analogy between Don Quixote and a mathematical object should not be taken too far. Don Quixote exists *fictionally*, i.e. it is intentionally posited in a fictional context so we can *pretend* he exists only in that context. A mathematical object, instead, is posited in a formal context so we say it exists *formally* if it satisfies the formation rules explicitly formulated in that specific context. Neither Don Quixote nor the mathematical objects exist *materially*, because they do not change.

Chapter 12

Emergent Materialism Implies Continuism/Emergent Materialism Does Not Imply Continuism



Íñigo Ongay and Javier Pérez-Jara

Abstract This discussion focuses on whether Mario Bunge's emergent materialism implies continuism or not. Íñigo Ongay defends that Bunge's emergent materialism implies continuism. In his response, Javier Pérez-Jara argues that Bunge's emergent materialism explicitly assumes structural ontological and epistemological discontinuities in the universe. The question is more than a Scholastic one, concerning only a particular system of philosophy, however relevant for current philosophical materialism. Rather, what is at stake is the ability of non-reductionist ontologies to explain (non-miraculous) novelty and plurality.

12.1 Emergent Materialism Implies Continuism (by Íñigo Ongay)

As it is the case with countless other philosophical thesis, emergentism is a monster of many faces. Depending on how it is formulated, the thesis of emergentism may pose a variety of different metaphysical and epistemological questions that we should do well to disentangle carefully. In conformity with the requirements of this section, I begin by characterizing emergentism as the rather vague contention that the general ontology of the universe presents a structure where strata of increasing complexity supervene on each other in virtue of the interactions between their respective parts. Within the context of such a layered view of the world, the properties of a system will be considered emergent with respect to those of the previous systems if and only if they are irreducible to the sum of the parts the

Í. Ongay de Felipe
University of Deusto, Bizkaia, Spain
e-mail: inigo.ongay@deusto.es

J. Pérez-Jara (✉)
Beijing Foreign Studies University, Beijing, China
Yale University, New Haven, CT, USA

later consists of. So described, this ontological understanding of nature is attuned to a corresponding epistemic thesis that recognizes a plenitude of special sciences (Fodor 1973), each of which will be seen as explanatorily autonomous with regard to all the others as well as to fundamental physics. It is noticeable that the association among the ontological and the epistemic claims is not accidental since both of them keep the same pluralistic and (rather vaguely) anti-reductionist *family resemblance*.

Although this description of what emergentism involves may seem plausible at first sight, it gives rise to a further metaphysical query about the substratum on which the whole process of emergence is predicated. Simply put, if what emerges are sets of properties arising when the complexity of a system reaches a critical point, what is the nature of the substance they emerge from? While there are various ways to answer this question, one of the founding fathers of the debate on emergentism has a pretty definite position with long reaching consequences both for the unity of the world and the harmony of science. Here's how C.D. Broad tackles the question at hand in his *The Mind and its Place in Nature*:

There is one uniform law of composition, connecting the behaviour of groups of these particles as wholes with the behaviour which each would show in isolation and with the structure of the group. All the apparently different kinds of stuff are just differently arranged groups of different numbers of the one kind of elementary particle; and all the apparently peculiar laws of behaviour are simply special cases which could be deduced in theory from the structure of the whole under consideration, the one elementary law of behaviour for isolated particles, and the one universal law of composition. On such a view the external world has the greatest amount of unity which is conceivable. There is really only one science, and the various "special sciences" are just particular cases of it. (Broad 1925, 76).

Notice that in the light of this version of emergentism, the diversity of ontological levels of the world gives no reason to deny the substantial unity of its underlying material and neither does the plurality of special sciences count against their hierarchical integration with one other. In view of the incommensurability that characterize the relationships between domains at their present state of development I don't find this view particularly appealing but that is not the point I want to make in here. In turn, I hope that the reader agrees that whether or not this particular type of pluralism is either ontologically or epistemologically correct, it does involve a strong form of continuism.

One of the advantages of such a claim about the continuity of the world lies in its alignment with the rather familiar idea that there are different special sciences devoted to the study of corresponding levels of nature. This may look as a sensible attitude to endorse if one wishes to adopt a materialist and anti-reductionist standpoint, but note further that the Fodorian suggestion that some sciences *are* special presupposes a strong commitment to the less plausible assumption that there is one fundamental discipline (i.e.: Physics) of which the former are special cases. I am skeptical about the soundness of this assumption but again that is not the point I want to argue in this context. Instead of that, I will just sustain that if this undoubtedly pluralistic image of how different scientific disciplines relate to one another were to be accepted then that would be a reason for believing that science constitutes a harmonic composite consisting of continuous parts.

In spite of the differences that separate C. D. Broad's doctrine from other articulations of emergentism such as those due to Samuel Alexander (1920) or Lloyd Morgan (1923), they all share the same differentiation between fundamental and subsidiary substrata. This doesn't mean that the properties of the more complex levels are reducible to the lower ones (in point of fact the emergentist thesis starts off by contending that there are ways in which they aren't so reducible) but certainly entails that they are all parts susceptible to be integrated into a coherent whole.

Let me consider now another interpretation of the idea of emergence that really diverges from continuism by renouncing the postulation of a general substratum from which an array of irreducible emerging properties arises. In Henri Bergson's account for example (Bergson 1911), emergence is considered as a force bringing about absolute novelty in a process of evolution that resembles in some respects the familiar theological concept of creation *ex nihilo*. It is worthwhile to observe that this understanding of the emergence process implies a strong ontological discontinuity between the different levels of the universe but it does so at the price of reintroducing a way of thinking about evolutionary novelty that runs afoul of the requirements of materialism. In his *Emergence and Convergence* Mario Bunge presents a critique to some of the implications of modern quantum cosmology:

Whatever emerges does so from some pre-existing thing: this is one of the ontological presuppositions of all science and technology. For example, the earliest organisms are said to have been the final products of a process of stepwise self-assembly starting from pre-biotic materials (yes, there must have been spontaneous generation, but it is likely to have taken a billion years or so). And yet there is one rather fashionable theory, namely quantum cosmology, which postulates that the universe originated *ex nihilo* through what quantum physics call a tunneling process. Clearly, this hypothesis contradicts Lucretius' famous principle *Ex nihilo nihil fit*, exemplified by the energy-conservation principle, and that has always been regarded as a cornerstone of every naturalistic cosmology, whether philosophical or scientific. (Bunge 2003, 32).

Here Bunge seems to assume that while nothing derives *ex nihilo* and thus there cannot be absolute novelty in the universe, there's a plenitude of cases in which the interactions between parts of a system gives rise to holistic dynamics of further complexity with properties and patterns of behavior those parts don't exhibit when taken in isolation. I don't see how it is not arbitrary to say that there is more complexity, say, in a eukaryotic cell than there is in the organelles it comes from via endosymbiosis. Nonetheless, with that qualification in mind I agree with Bunge that various scientific disciplines are awash with examples of structural wholes that cannot be screened off by the laws governing their integrative parts: from the atoms of helium and hydrogen with respect to a molecule of hydridohelium to the results of the stigmergic coordination of the pheromone-guided behavior of a colony of ants to the complex architecture of a giant termite nest or to the formation of social and political patterns of interaction in human culture out of the ethological and ecological laws of behavioral biology and primatology. When considering this sort of processes, Mario Bunge insists that we should always do well to resist the temptation of heedlessly identifying a single universal mechanism accounting for such a flamboyant variety of processes in a multitude of scientific areas of concern.

Again I think he is right about that. But this qualification to the emergentist thesis leaves us with a puzzle: what good does it do to appeal to the general notion of emergence if the real heuristics is to be left in the hands of the multitudinous and very different mechanisms provided by the different sciences?

I think it is impossible to avoid continuism if the version of emergentism one favors involves viewing the world as a unified system of systems all emerging from the same fundamental level with the different sciences exhibiting a similar order of hierarchical integration. A framework like that is at home with metaphors of undeniable continuist flavor as that of *scala naturae* (Bueno 1999), which in turn powerfully contrast with other ontological understandings of the world that emphasize discontinuity over universal continuity and connection. In that regard it is worth considering such notions as those of *patchwork* or *tapestry* employed by philosophers like Nancy Cartwright (1994) or Gustavo Bueno (2016).

Surely there might be other versions of the emergentist thesis that don't entail the systemic unity of our ontologies and epistemologies. If emergence is made to be used as a surrogate term for the irreducibility and the incommensurability that separate the diverse ontological and epistemological categories of the world then I don't think that this implies continuism. But if so, it would be dubious to the extreme whether such a deflated usage of the metaphor will still keep any resemblance to its original meaning.

12.2 Emergent Materialism Does Not Imply Continuism (by Javier Pérez-Jara)

Emergentism and materialism are key philosophical notions that have an undeniable significance in many scientific investigations, from quantum physics to sociology, economics or international relations. Sometimes, emergentism and materialism crisscross each other, whereas in other occasions they travel antagonistic paths. As such, the notion of emergence has occasionally been used in creationist and spiritualist contexts, while in other instances has been used by materialist ontologies. Within this last category, emergent materialism is a philosophical system¹ which has been mainly developed by Mario Bunge throughout many decades of investigations, classes, talks, and publications.

If by *continuism* we understand a worldview that either denies (or at least severely downplays) ontological and epistemological discontinuities in the universe and in our knowledge of it, I will advance my main thesis: emergent materialism

¹ This philosophical system is also known as “scientific materialism” or “systemic materialism”: see Bunge’s chapter in this volume.

does not imply continuism. In order to follow my argumentation, two important clarifications are needed:

1. With the only exception of what Gustavo Bueno called “positive emergence” (in which the whole is always prefigured by the parts, and therefore there is no real novelty: see Bueno 1993), the notion of emergence always dismisses the metaphysical continuism and neophobia implied by radical monism. Emergent materialism follows this anti-continuist and anti-neophobic tradition.² Nevertheless, despite some partial convergences, the notion of emergence in Bunge’s philosophy should not be confused with the one of creationist emergence (which implies a contradictory *creatio ex nihilo*), nor with the notion of supervenience, which Bunge also rejects and sees in it no utility at all for the scientific research (Bunge 2014[2003]; Bunge 2010, 162).
2. In Bunge’s emergent materialism, emergence works together with other ontological phenomena in taking ontological and epistemological discontinuities into account.

Now that these two important considerations are clear, I will divide my remaining text into two parts: in the first one, I will provide some key excerpts from Bunge himself that show how he explicitly and repeatedly defends that emergent materialism *does not* imply continuism. On the other hand, in the second part, I will very briefly summarize my main reasons to hold that identifying emergent materialism with a crypto-continuist metaphysics would also be a wrong statement.³

I. Brief Sample of Excerpts on the Importance of Discontinuities for Emergent Materialism

1. On emergent materialism’s “principle of discontinuity” in general:

[There are qualitative discontinuities] among classes of coexistents, and qualitative jumps occur at critical points in processes (this being why they are called ‘critical’). (. . .) If there are qualitative discontinuities, qualitative jumps in processes, there can be, strictly speaking, no continuity of forms, no *plenum formarum*. This is confirmed by the bare fact that classifications of material existents are possible; if there were no abrupt qualitative differences at least in *some* respects, most classification would be impossible, since classifications are based on qualitative differences. A “principle of discontinuity” is inherent in all of our classifications, whether of mathematical, physical, or biological objects.⁴

² Among the many philosophical sources of Bunge’s emergent materialism, it is important to cite here Roy Woods Sellars’ “emergent realism”, which combined systemic materialism with emergentism and scientism (Sellars 1969[1922], Sellars 1970).

³ For instance as Spinoza, despite defending the existence of “God”, is considered a crypto-atheist by many authors.

⁴ Bunge (2009[1959]), p. 143.

The hypothesis of continuity has, in short, a very wide but—like every other known law—limited domain of validity. In both nature and society there are processes involving definite quantitative and qualitative changes that violate the continuity required by causality; there is, besides, and as a result of such jumps, the discontinuity of existents.⁵

Continuity in some respects is consistent with discontinuity in others, just as change in some respects is consistent with permanence in others.⁶

Although there is no universal emergence mechanism, it can safely be conjectured that nothing emerges *de novo*: that every new thing develops or evolves from pre-existing things, so that there is continuity or conservation along with discontinuity or novelty.⁷

Discontinuous processes, though common and of great heuristic importance, are not universal. An even when they do take place it is worth while to try to analyze them further instead of taking the component events *en bloc* as was done above. This need not be done in the preliminary stages of a science—e.g. in learning theory at the present moment—but it is an ultimate desideratum. Finally because discontinuous processes do not exhaust the process genus, it makes no sense to ask about the number of events that have occurred during the history of the universe—not even during the last second of its existence.⁸

All long-term histories are gradual in some respects (properties) and discontinuous in others.⁹

2. Ontological discontinuity and causality:

Continuity and discontinuity are complementary categories; the problem is not to reduce one to the other, but to investigate whether continuous processes at one level are made up of jumps at another level and, vice versa, whether jumps are resolved into continuous processes at a different level. The consequence of all this for causality is obvious: the mere fact that the hypothesis of continuity is not universally valid entails a limitation upon the range of validity of the causal principle.¹⁰

The emergence of new levels, that is, of definite qualitative discontinuities, dispenses us from tracing back the entire past history in every single case.¹¹

⁵ Bunge (2009[1959]), p. 145.

⁶ Bunge (2009[1959]), p. 145.

⁷ Bunge (2010), p. 88.

⁸ Bunge (1977), p. 244.

⁹ Bunge (2003), p. 29.

¹⁰ Bunge (2009[1959]), p. 146.

¹¹ Bunge (2009[1959]), pp. 146, 147.

Continuity is essential to causality, but no more essential to the world than discontinuity, with which it is intimately connected.¹²

Instability is, in short, a source of causal discontinuity in classical physics.¹³

3. Ontological discontinuities in physical matter:

Let us return to the task of listing the most common features of nature. Another supposedly universal trait is continuity: *Natura non facit saltus*. All changes are incremental, none are discontinuous: there can be no quantum jumps. In particular, the energy of a body increases or decreases in a continuous manner. (. . .) However, classical physics did admit several discontinuities, such as the abrupt change in the velocity of a solid body upon impact on a solid surface; uncounted threshold effects; the occurrence of a denumerable set of modes of vibration of an elastic body; phase transitions, such as liquid → gas, and paramagnetism → ferromagnetism; and the quantization of electric charge, which Faraday discovered in electrolysis.¹⁴

An increase or decrease in the energy of an atom is a discontinuous transition or quantum jump—an expression that has enriched ordinary language. Such discontinuities motivated the introduction of the neologisms quantum theory, quantization, and quantum.¹⁵

The discontinuity in the photoelectric effect.¹⁶

The random spin directions of an iron bar, initially random, will tend to align themselves in a given direction on introducing the bar into a magnetic field. This kind of randomness is ontological, not epistemological, and therefore Bayesian (or subjectivist) probability theorists have nothing to say about it. Not even God could foresee exactly where each particle in an incident atomic beam will end up.¹⁷

4. Ontological discontinuities in biological matter:

It is now generally agreed that denial of *saltation* is just as incompatible with evolution as denial of continuity: that evolution at all levels is gradual in some respect and discontinuous in others.¹⁸

There are continuities as well as discontinuities in the evolution of any phylum.¹⁹

¹² Bunge (2009[1959]), p. 146.

¹³ Bunge (2009[1959]), p. 141.

¹⁴ Bunge (2010), p. 27.

¹⁵ Bunge (2010), pp. 27, 41.

¹⁶ Bunge (2009[1959]), p. 143.

¹⁷ Bunge (2016), p. 264.

¹⁸ Bunge (2010), p. 82.

¹⁹ Bunge (2010), p. 196.

All developmental and evolutionary processes are continuous in some respects because of the conservation of certain constituents or features. At the same time, those processes are discontinuous in other respects by virtue of the birth and disappearance of qualitative novelties.²⁰

Paradoxical as it may seem, real evolution is inconsistent with strict continuity in all respects, just as it is inconsistent with the discontinuous emergence of newness out of nothing.²¹

II. Emergent Materialism as an Anti-Continuist Metaphysics

So far, I have offered key examples that show, in Bunge's own words, the explicit importance of discontinuities for emergent materialism. Against the *continuism* implied by radical monist metaphysics, emergent materialism unquestionably emphasizes that a complex and rich interplay of ontological continuities and discontinuities structures reality. The existence of insurmountable ontological discontinuities can be observed in *both* the emergent levels that compose the universe and within each specific level. Thus, on the one hand, there are ontological discontinuities between the physical, chemical, biological, social, and technical levels: each one of these ontological dimension presents qualitative novelties irreducible to the previous and following ones. Such ontological irreducibility implies ontological discontinuities.

These ontological discontinuities have a crucial significance in the epistemology of sciences: from the point of view of chemistry, for instance, it is impossible to explain economic crisis, just as from the point of view of economics is impossible to understand chemical reactions. Similar considerations can be done for other sciences. Aside of very specific and limited reductions (see Bunge 2010), sciences are mostly irreducible to each other. In Bunge's words: "for better or for worse, reduction has failed more often than it has triumphed, largely because it has denied emergence." (Bunge (2014[2003], 177). It is for this reason that Bunge has strongly criticized multiple and well-known epistemological reductionisms, from physicalism, biologism, neuroimperialism, and psychologism, to linguistic imperialism, sociologism, economism, politicism, culturalism, and computationism (Bunge 2010, 103, 104–108, 117, 119; Bunge 2014[2003], 159–177).

Aside of the ontological discontinuities that we find between different levels of emergence, there are also ontological discontinuities *within* each level of emergence. In order to illustrate this thesis, I have offered some important examples of ontological discontinuities in physical and biological matter provided by Bunge himself. In Bunge's works, it is also very easy to find many other examples of ontological discontinuities in chemical, social, and technical matter.

Equally wrong would be identifying emergent materialism with a form of what Bueno (1972) called "monism of order", according to which everything is connected harmonically with everything else. At every emergent level, Bunge states that everything in the universe is connected to *some* other realities, but not to everything

²⁰ Bunge (2003), p. 29.

²¹ Bunge (2009[1959]), pp. 144, 145.

else (Bunge 2006: 21). Furthermore, emergent materialism emphasizes the key role of randomness and chaotic (or “nonlinear dynamics”) processes in the universe: see Bunge 2010, 30–31.

The ontological intra-level discontinuities also have an important epistemological significance in the plurality of sciences. It is for that reason that for emergent materialism, there are more sciences than levels of emergence (Bunge 2014[2003]; Bunge 2010). The dangers posed by the fragmentation between different irreducible scientific perspectives can be lessened by the epistemological strategies of integration and cross-disciplinarity (Bunge 2014[2003]). But these research strategies do not make the epistemological irreducibility among sciences to fade away or disappear; on the contrary, they are supported on the ontological discontinuities present in the universe itself,²² rather than on arbitrary human conventions, as radical constructivism and epistemological relativism claim. In other words: the integration of, for instance, biological, psychological, economic, political, and sociocultural perspectives into a broader and unitary theory of family does not cancel the structural irreducibility between these particular scientific perspectives. In Bunge’s epistemology, integration (or convergence) presupposes discontinuities, just as the ontological unity of the universe as a “system of systems” presupposes structural ontological discontinuities, against the “holist dogma” of the universe as an “unanalysable solid bloc” (Bunge 2014[2003], 188). Moral: Discontinuity and unity are not exclusive terms (a thesis that Bunge shares with Bueno’s ontology: see Bueno 2016).

To sum up: Bunge’s emergent materialism strongly criticizes continuism both horizontally and vertically. Vertically, this philosophy emphasizes discontinuities between each level of emergence, from physical matter to artificial matter. Horizontally, it stresses multiple discontinuities within each level of emergence without renouncing to lawfulness. I am far from agreeing with Bunge in several important philosophical topics (see my chapter in this volume). And yet, I hold that emergent materialism’s “principle of discontinuity”, along with its specific application to concrete fields of analysis, is among the most valuable things of this powerful system of thought.

12.3 Response (by Íñigo Ongay)

In his comments Javier Pérez Jara defends Mario Bunge’s philosophy from the charge of continuism. In particular he does that by adopting a twofold strategy: first, the author offers an ample array of excerpts offering textual evidence that

²² The complex interplay of ontological and epistemological continuities and discontinuities in emergent materialism is also reflected by the peculiar case of some ontological reductions (such as identifying the mental and the neural) compatible with epistemological irreducibility (psychology is not reducible to neuroscience): see Bunge 2014[2003], 151.

Bunge doesn't explicitly endorse continuism. Second, he goes on to advance the contention that it would be equally wrong to accuse Bunge of falling more implicitly into a crypto-continuist view of the world or of our scientific knowledge about it. Although focusing the discussion on Mario Bunge's case has obvious methodological and practical advantages given the nature of this volume, my first piece starts off by locating the debate on the consequences of emergent materialism within a broader context of less recent vintage. I argue that doing so is helpful in that its importance notwithstanding, Bunge's version of systemic emergentism is by no means the only ontological framework that presents both a materialist and an emergentism understanding in ontology and epistemology. By means of example, turning the attention to C. D. Broad's classical articulation of emergent materialism (Broad 1925) is worthwhile in that it shows that when it comes to some of its most conspicuous proponents of the first half of the twentieth century the idea of emergence exhibits a strong commitment with the thesis that in the universe there is "only one type of stuff" on which the diversity of the levels of emergence is then subsequently predicated. Also, such an account of the ontological unity of the world tends to be associated with an epistemic claim about the integration of science, which generally distinguishes general from especial scientific disciplines. It is easy to see that given the context of philosophical and scientific debate during much of the twentieth century, physics is usually understood as the privileged level at which emergence starts with other scientific disciplines, from biology to psychology or sociology, playing second fiddle as special sciences (Fodor 1973). In any case, both in ontology and in epistemology the point to be made is the same: *there is a fundamental level of unity underlying plurality*. I think there is no way to make this substantial case without presupposing a continuistic framework of reference.

Turing to Mario Bunge's philosophy, Javier Pérez Jara quotes with approval a wealth of passages where Bunge denies the reducibility among various scientific levels and emphasizes the very many qualitative differences between them. I agree that Bunge's ontology has such a commendable anti-reductionist flavor. Actually, my original paper refers to some of the sides of Mario Bunge's strategy when it comes to the critique of reductionism in philosophy of mind.

It is hardly surprising that this should be so since the mechanism of emergence is usually presented as an alternative to both reductionism and creationism thus attempting to avoid the false dilemma between neophobia and *creation ex nihilo*. Comparably, F. Engels (1954), a philosopher who did not make explicit reference to the notion of emergence, advocates an ontological doctrine where in spite of the multiplicity of transitions from quantity to quality, there is still a substantial unity in nature based upon the (very) general idea of matter. If we agree that the way Engels thought of such a material integration of the multiplicity of qualitative levels assumes the continuity between them (Bueno 1972), I don't see how Bunge can avoid a similar sort of continuism. The point of the matter here does not lie with the recognition of plurality or the debunking of reductionism but with the interpretation of such plurality as forming a hierarchy of "levels" of integration which, proceeding from a fundamental substratum, gives rise to systems of organization susceptible of constituting a system of systems (Bunge 1979). When this Matryoshka dolls-

like image of the nesting unity of the world is presented there is no need for any additional reductive statement to imply continuism: this nesting view of the “integration” of “levels of complexity” is precisely just about all that continuism involves.

It might be argued that different from the holistic view of the universe that Engels defends, Mario Bunge unequivocally denies that all the different levels of complexity are universally connected with one another and thus his account balances out both the moments of continuity in the different aspects of the universe and the discontinuity among its parts. I agree that Bunge’s philosophical doctrine is highly sophisticated and contains a variety of qualified nuances but I think there is trouble with the consistency of the relation at which some of these aspects stand some others. In particular if the type of emergence we think of presupposes (as it seems) a fundamental level from which the entire process derives then, no matter what Bunge may have wanted to say, such primordial level seemingly containing, however virtually, all the pluralities to come is just about all that is needed for continuism. If it doesn’t imply any such an appeal to a primordial substratum then there would be in effect some room left for the recognition of the discontinuities and incommensurability between the diverse parts of the world but at the price of making the usage of the notion of emergence quite disanalogous and blurry. As I said in my first piece the thesis of emergence entails different consequences depending on how it is fleshed out but it is important to notice that we can stretch the logic of the metaphor of emergence just so much before the analogy starts crumbling. Javier Pérez Jara says that we should avoid mistaking all sorts of emergentism with what Gustavo Bueno (1972) calls “positive emergence”. I see the point to that distinction but want to point out that if emergence is a variegated philosophical thesis, positive emergence is its *analogatum princeps*.

Does Materialist Emergentism Imply Continuism? Javier Pérez Jara gives a clearly negative answer to this question. As suggested in my first text, my own reply, on the other hand, wouldn’t be unqualifiedly positive as I believe that it is important to see the extent to which the use of the metaphor of emergence may have very different implications depending on how it is articulated in each case. What I fear however is that when emergence fails to have such implication, it just falls into an improperly vague use of the concept beyond what the analogy itself suggests.

12.4 Response (by Javier Pérez-Jara)

Íñigo Ongay offers compelling arguments to hold that emergent materialism implies continuism. Ongay and I agree in several important points, such as that there are many different varieties of materialism and emergentism. Within this plurality, this brief philosophical discussion was planned from the very beginning to focus on Mario Bunge’s emergent materialism, which Ongay describes in this debate and elsewhere (2019) as a continuist philosophy. In line with that thesis, in

the present discussion Ongay compares Bunge's philosophy with both Broad's metaphysics and its "emergences", and with Engels' dialectical materialism and its "qualitative jumps". I do also agree in that these comparisons are pertinent to a full understanding of Bunge's materialist ontology, but often by way of contrast. For instance, Broad famously held that mental phenomena, although emergent from neurophysiological processes, can be independent from them. This dualist thesis led him to the belief in supernatural phenomena such as the survival of the mind after the brain's death (Broad 1925, 1949, 1962). The conclusion seems obvious: despite their common rejection of physicalism, Bunge explicitly opposed Broad's spiritualism.²³

The affinities between Bunge's emergent materialism and Engels' dialectical materialism are more relevant, but in a different direction as the one proposed by Ongay. "If we agree", Ongay writes in his response, "that the way Engels thought of such a material integration of the multiplicity of qualitative levels assumes the continuity between them (Bueno 1972), I don't see how Bunge can avoid a similar sort of continuism." This critique, however, deserves two considerations:

1. Bunge explicitly rejects Engels' qualitative jumps. In his words: "[another] confusion of materialist dialectics is the so-called third law of dialectics, namely the 'transformation of quantity into quality and conversely'. Such transformation is just impossible."²⁴ According to Bunge, Engels' qualitative jumps are therefore a clumsy and obscure way of talking about real mechanisms of emergence that just cannot be explained through Hegelian dialectics.
2. Engels' qualitative jumps are directly taken from Hegel's *Science of Logic*. Interestingly, though, both Hegel and Engels posed these jumps as arguments against continuism. Hegel, explicitly criticizing the continuist principle "*Natura non facit saltum*", argued that "we have seen that the alterations of being in general are not only the passing over of a magnitude into another magnitude, but the transition from the qualitative into the quantitative and contrariwise, a becoming—other that interrupts gradualness and stands over against the preceding existence as something qualitatively other."²⁵ Following his critique on continuist gradualism, Hegel offered clear examples of ontological discontinuities in reality, from physics and chemistry to the ontological phenomenon of death. Inspired by this Hegelian thesis, Engels also contended the existence of important ontological discontinuities in the world. Lastly, Ongay quotes Gustavo Bueno to support his own identification between Engels' jumps and continuism. Nevertheless, in the cited work, Bueno writes: "Engels, despite his clear monistic features, protested against the identification between monism and mechanism (as in Haeckel), *underlining the discrete differences of the*

²³ Bunge (1980), p. 11.

²⁴ Bunge (2010), p. 125.

²⁵ Hegel (2010[1813–1832]), p. 322.

World's strata.”²⁶ (italics mine). Such discrete differences imply ontological discontinuities, despite Engels' simplistic analyses on other philosophical topics.

Let us then directly examine Bunge's emergent materialism. According to Ongay, in my first contribution to this discussion I offered “textual evidence that Bunge doesn't explicitly endorse continuism”. More accurate would have been to state that I set forth many crucial texts showing textual evidence that Bunge explicitly and repeatedly defends a Principle of Discontinuity that applies to all kind of domains in the universe, both within each level of emergence and between each level of emergence. Although Ongay recognizes that Bunge's philosophy is “highly sophisticated and contains a variety of qualified nuances”, he also holds that “it is impossible to avoid continuism if the version of emergentism one favors involves viewing the world as a unified system of systems all emerging from the same fundamental level (. . .) A framework like that is at home with metaphors of undeniable continuist flavor as that of *scala naturae* (Bueno 1999), which in turn powerfully contrast with other ontological understandings of the world that emphasize discontinuity over universal continuity and connection.” Against this, I would emphasize again that: (1) Bunge's idea of system in general, and specifically his idea of the universe as “a system of systems” necessarily imply ontological discontinuities (in a similar way as in Bueno's ontology the World's unity and uniqueness implies ontological discontinuities: see Bueno 1993); (2) when Bunge talks about the universe's ontological hierarchies, he emphasizes (for instance against perspectives such as Bruno Latour's “flat ontology”) that there are structural asymmetrical relationships in the universe: for instance that political systems imply biological, chemical, and physical realities, but gamma rays (unless we endorse radical constructivism) do not imply political or economic systems. Such asymmetrical material relationships necessarily imply ontological discontinuities, against upwards and downwards ontological reductionisms; (3) Bunge's ontology could not be farther from a metaphysics that defends “universal continuity and connection”.

On the other hand, both Ongay and I criticize Bunge's view of physical matter as a primordial substratum. Despite that, there are some divergences in our interpretation of Bunge's ideas on this point. Ongay contends that:

No matter what Bunge may have wanted to say, [Bunge's ontological] primordial level seemingly containing, however virtually, all the pluralities to come is just about all that is needed for continuism. If it doesn't imply any such an appeal to a primordial substratum then there would be in effect some room left for the recognition of the discontinuities and incommensurability between the diverse parts of the world but at the price of making the usage of the notion of emergence quite disanalogous and blurry.

And yet, one of the most salient philosophical enemies of Bunge's emergent materialism is neophobic metaphysics, according to which (in Bunge's words)

²⁶ Bueno (1972), p. 77. In the original: “Engels, pese a sus rasgos claramente monistas, protestaba de la identificación entre el monismo y el mecanicismo (en Haeckel) subrayando las diferencias, con carácter discreto, de los estratos del Mundo.”

“whatever appears to be new actually existed previously in a latent form: that all things and all facts are ‘pregnant’ with whatever may arise from them. An early example of such neophobia is the conception of causes as containing their effects, as expressed by the scholastic formula ‘There is nothing in the effect that had not been in the cause’.”²⁷ For that reason, I stressed that Bunge’s notion of emergence cannot be identified with what Bueno (1993) called “positive emergence”. For Bunge, physical matter *does not* contain virtually all the partially discontinuous plurality that comes later, from chemical matter to artificial matter. Furthermore, we also saw how for Bunge there are multiple and crucial ontological discontinuities in physical matter, from causal processes to quantum events: emergences, despite their key importance, only represent a part of the ontological discontinuities that we can find in the universe.

To sum up: Bunge’s Principle of Discontinuity and his notion of emergence are not only compatible; they require each other. Bunge’s conception of emergence does not blur or fade because it can be applied to all kind of ontological domains and there is not a universal emergence mechanism (Bunge 2003, 2010). Despite the variety of contexts in which emergent materialism talks about emergences (atoms, chemical elements, nervous systems, families, governments, technological devices), all have in common: (1) being systems with a composition, structure, mechanism, and environment; (2) every system has qualitative properties that their components lack (for instance: living beings equipped with nervous systems develop psychic activity, but not cells or isolated organs). Such coming into being of qualitative novelty is what Bunge understands by emergence, against the neophobia held by aggregationist metaphysics.

References

- Alexander, S. 1920. *Space, Time and Deity*. London: Macmillan.
- Bergson, H. 1911. *Creative Evolution*. London: George Allen and Unwin
- Broad, C.D. 1925. *The Mind and Its Place in Nature*. London: Routledge and Kegan Paul.
- Broad, C.D. 1949. The relevance of psychical research to philosophy. *Philosophy* 24(91):291–309.
- Broad, C.D. 1962. *Lectures on Psychical Research*. London: Routledge & Kegan Paul.
- Bueno, G. 1972. *Ensayos Materialistas*. Madrid: Taurus.
- Bueno, G. 1993. *Teoría del cierre categorial. Vol 5: El sistema de las doctrinas gnoseológicas. Adecuacionismo. Circularismo*. Oviedo: Pentalfa.
- Bueno, G. 1999. Los límites de la evolución en el ámbito de la scala naturae. In *Evolucionismo y Racionalismo*, E. Molina, A. Carreras, and J. Puertas, 49–87. Zaragoza: Institución Fernando el Católico & Universidad de Zaragoza.
- Bueno, G. 2016. *El ego trascendental*. Oviedo: Pentalfa.
- Bunge, M. 1977. *Treatise on Basic Philosophy. Vol. 3: The Furniture of the World*. Dordrecht: Reidel Publishing Company.
- Bunge, M. 1979. *Treatise of Basic Philosophy. Ontology II: A World of Systems*. Dordrecht: Reidel.

²⁷ Bunge (2010), p. 88.

- Bunge, M. 1980. *The Mind-Body Problem: A Psychobiological Approach*. Oxford: Pergamon Press.
- Bunge, M. 2003. *Emergence and Convergence: Qualitative Novelty and the Unity of Knowledge*. Toronto: University of Toronto Press.
- Bunge, M. 2006. *Chasing Reality: Strife over Realism*. Toronto: Toronto University Press.
- Bunge, M. 2009[1959]. *Causality and Modern Science: Fourth Revised Edition*. New Brunswick: Transaction Publishers.
- Bunge, M. 2010. *Matter and Mind: A Philosophical Inquiry*. New York: Springer.
- Bunge, M. 2014[2003]. *Emergence and Convergence: Qualitative Novelty and the Unity of Knowledge*. Toronto: University of Toronto Press.
- Bunge, M. 2016. *Between Two Worlds. Memoirs of a Philosopher-Scientist*. New York: Springer.
- Cartwright, N. 1994. Fundamentalism vs the patchwork of laws. *Proceedings of the Aristotelian Society* 94:279–292.
- Engels, F. 1954. *Dialectics of Nature*. Moscow: Foreign Languages Publishing House.
- Fodor, J. 1973. Special sciences. *Synthese* 28:97–115.
- Hegel, G.W.F. 2010[1813–1832]. *The Science of Logic*. Cambridge: Cambridge University Press.
- Morgan, C.L. 1923. *Emergent Evolution*. London: Williams and Norgate.
- Ongay, Í. 2019. Cuerpo, mente y emergencia. *El Catoblepas* 189:1. <http://www.nodulo.org/ec/2019/n189p01.htm>.
- Sellars, R.W. 1969[1922]. *Evolutionary Naturalism*. New York: Russell & Russell.
- Sellars, R.W. 1970. *Principles of Emergent Realism*. St. Louis: Warren H Green.

Chapter 13

Materialism Is False/Materialism Is Not False



Graham Harman and Javier Pérez-Jara

Abstract This discussion concerns whether philosophical materialism is false or not. The exchange between Graham Harman and Javier Pérez-Jara goes to the core of the present book: what is materialism, how many varieties are there, and what use are they today? While Harman identifies materialism with reductionism, Pérez-Jara offers a broader definition that includes non-reductionist materialisms. It might seem to be just as a matter of differing definitions. And yet, each approach gives rise to a whole different way of reconstructing the history of philosophy as well as of deciding which are the current available options in metaphysics.

13.1 Materialism Is False (by Graham Harman)

Although materialism (often treated interchangeably with “physicalism”) is one of the best-known doctrines of philosophy, it is not even clear what it means. In its classic form, which imagines physical particles spinning through empty space, the positive features of matter are usually limited to its being firm, resistant to our efforts, a substratum for various changing forms, and the occupation of a specific location in space and time. But some of these purported features are merely negative, and historically speaking, materialism has functioned mostly as a whip to flog whatever benighted reactionaries one wishes to attack at any moment: monarchs, priests, the sexually repressed. Even those that are not just negative—say, the position of matter in space and time—are purely relational rather than intrinsic features of reality. Ultimately, I suspect that the main attraction of matter is its claim

G. Harman
Southern California Institute of Architecture, Los Angeles, CA, USA
e-mail: graham_harman@sciarc.edu

J. Pérez-Jara (✉)
Beijing Foreign Studies University, Beijing, China
Yale University, New Haven, CT, USA

to account for why knowledge resembles its object without being identical with it. Our knowledge of a star is obviously not itself a star, and few thinkers this side of Berkeley (1992) would even think of claiming otherwise. But if we consider a case in which our knowledge of a given star were *perfect*, then what would stop that knowledge from becoming a star? The easy answer for everyone is that a real star “inheres in matter” while our perfect knowledge of a star inheres in no matter other than the kind that makes up our brain. But there is a problem here: no one has ever encountered anything like “matter.” Everything we run across in the mind or the physical world has a *form*. But—explicitly or implicitly—we are so reliant on the idea that knowledge involves an extraction of forms from matter that we do not sufficiently consider that a star and our knowledge of a star are already different *in form*. This would entail that Kant (1996, 584) is wrong when he claims that 100 actual Thalers contain nothing that is not already found in 100 possible Thalers, leading to his purely relational theory that existence is a matter of “position.” To disagree with Kant we need not take the opposite view that being *is* a real predicate, but only that 100 actual and 100 possible Thalers have a difference in form that comes from the different pieces of which they are composed.

In recent years, a new ambiguity surrounding materialism has arisen. In its classical form, materialism asks us to view the world as made up of a rock-bottom layer of ultimate physical units. But in the cultural studies materialism found in much continental thought, the physical world is downplayed to the point of outright disappearance. Slavoj Žižek boldly asserts the following: “The true formula of materialism is not that there is some noumenal reality beyond our distorting perception of it. The only consistent position is that *the world does not exist*” (Žižek and Glyn 2003, 97). His strange intuition is followed by many others, leading Levi Bryant to complain aptly that “materialism has become a *terme d’art* which has little to do with anything material. Materialism has come to mean simply that something is historical, socially constructed, involves cultural practices, and is contingent. . . We wonder where the materialism in materialism is” (Bryant 2014, 2).

Yet what the two ostensibly opposite forms of materialism share is that both reduce the world to our knowledge of it. For there are two basic kinds of knowledge available: (1) we can explain what something is made of, (2) we can explain what it does, whether to the human intellect (Descartes, Husserl), to human praxis (Bergson, Heidegger), or to other entities as well (Whitehead, Latour). Classical materialism *undermines* objects by going to a deeper level; meanwhile, cultural materialism *overmines* objects by denying any deeply hidden essence or substance and focusing on how things manifest relationally (Harman 2011, 2013). But undermining cannot explain emergence (which it treats as merely epiphenomenal) and overmining cannot explain change (as Aristotle showed in the *Metaphysics* in his refutation of the Megarian thesis that everything is only what it is right now) (Aristotle 1999, 3 T). When Eddington (1929) speaks of the difference between his two tables, and Sellars (2007) of the parallel “manifest” and scientific “images,” what both miss is that reality is something entirely different from an image. The real table is a *third table*, with Eddington’s two tables being mere mistranslations of the primary one (Harman 2012).

13.2 Materialism Is Not False (by Javier Pérez-Jara)

“Materialism” is a key concept in philosophy that was coined by Robert Boyle in the seventeenth century (2008[1674]). As such, it is a fairly “recent” philosophical term that nonetheless is applied to millennial old systems of thought, from the Western to the Eastern tradition. That poses an important set of considerations. Among the most important ones, I would like to emphasize the following:

1. The concept of “materialism” is very often defined as the worldview that holds that everything that exists is either material or supported on material entities and processes. This kind of positive definition, although necessary, raises an important issue: the concept of matter is an ontological notion supported on scientific theories, which often change throughout time. What’s more, the same scientific theory is often interpreted very differently from different ontological and epistemological approaches. This does not mean, of course, that every philosophical interpretation is equally valid, or that every scientific theory is cursed to be outdated in the future; it means that the definition of materialism is a philosophical problem itself. In other words: it cannot be done outside the field of philosophy from a neutral point of view.
2. The projection of the term “materialism” onto systems of thought that did not self-classify as such opens important issues. Among them, for instance, it should make us aware of the need to move away from the common tendency of identifying, without further considerations, materialism with atheism. The Stoics, the Epicureans, David of Dinant, Spinoza, and Hobbes are often considered as materialist philosophers, despite holding, in different ways, the existence of God(s).
3. The critical awareness of the variety of materialisms presents us with a market that seems very heterogeneous and rich. As famous products of this market we can find: corporeist materialism, physicalist materialism, dialectical materialism, mechanistic materialism, holistic materialism, systemic materialism, eliminative materialism, Australian materialism, transcendental materialism, idealist materialism, speculative materialism, discontinuous materialism, feminist materialism, “new materialisms”... And the list goes on. How can we find an “Ariadne’s thread” that leads us through the labyrinth constituted by the idea of “materialism” without getting lost in the contingencies of radical historicism? Defining materialism, as with defining every other important concept, faces two opposite perils: definitions can be either *too narrow* or *too broad*. When definitions are too narrow, we have an ideological kidnapping (e.g. defining the divine in general by the Christian God); when, on the other hand, they are too broad, we face an efface of the species in the genus (e.g. defining philosophy just by “knowledge”).

In order to avoid these inaccuracies, I follow this general definition of materialism: positively, materialism, in general, names the branch of philosophical worldviews that identify *being* (the “ὄντως” of ontology) with *matter*, understood in its broadest sense as changeability and plurality (*partes extra partes*). Negatively,

materialism denies the independent ontological existence (from human conceptual imagination) of disembodied living beings and hypostatized ideas. I restrict here the denial of spirits to “literal” living beings, for there are also metaphorical living beings, such as many cultural creations that, although non-corporeal, seem to have a life of their own (a cultural life that, against Platonism, would of course fade away without humans). Examples include our dead ancestors’ cultural weight and figures of fiction who shape human communities in a stronger way than many real/literal living beings. From this point of view, a crucial enemy of materialism is literalist spiritualism, including both the ethnological or folk animism studied by anthropologists and the more sophisticated metaphysical spiritualism developed millennia later by the so-called first philosophers in the Eastern and Western traditions. Despite these oppositions, and against radical binary logic, we can always find some partial convergences between materialist philosophies and spiritualist and idealist worldviews.

Within this general definition of philosophical materialism, we could distinguish between “hard materialisms” and “soft materialisms”. The first ones deny the very possibility of disembodied literal living beings and hypostatized ideas, while the second ones only deny their existence, but without holding that pure spirits and ideas are impossible, just highly unlikely to exist. For hard materialisms, the denial of the possibility of spiritualism and Platonism comes from a variety of philosophical reasons heavily supported on scientific evidence (Pérez Jara 2014). The critical analysis of psychological and abstract realities’ contents, structures, and mechanisms shed light on a key conclusion: such as in Lewis Carroll’s *Alice’s Adventures in Wonderland* (1992[1898]), “a grin without a cat” made no sense, there cannot be minds and ideas without complex physical, chemical, and biological entities and processes. Complex minds and ideas even require very sophisticated sociocultural systems of interactions. To sum up: minds and ideas are always embedded in non-psychedic and non-abstract realities.

This argument would be extensive to that utmost spiritualism represented by the ontotheological God. Furthermore, the contradiction between this God’s personal and therefore psychological nature and His disembodied nature is just one contradiction among many others. As a mosaic of incompatible ideas brought together into an impossible totality, the ontotheological God is in truth a pseudo-concept (Martin 1989; Martin and Monnier 2003; Bueno 2007, 2019; Pérez Jara 2005, 2014; Ongay 2020). Among other conclusions, this means that the philosophical question: “does (the ontotheological) God exist?” is a badly formulated question, for it implicitly implies that such God is possible. That said, these considerations do not always apply to non-ontotheological and non-ontic conceptions of the divine which do not identify the divine with a literal personal being, such as the ones developed by radical negative theology, Heidegger’s “Last God”, or some Eastern Taoist, Buddhist, and Shinto traditions.

The tendency of hypostatizing the psyche and concepts or ideas comes from metaphysics’ general tendency to hypostatize entities, properties, states or events. If mythological thinking’s main “pathology” is the tendency towards literalist anthropomorphism and zoomorphism, the main pathology haunting metaphysics

is the tendency towards hypostatization (Bueno 1970). Since, according to the legend, Medusa turned changing and dynamic realities into stone, I suggest to dub this hypostatizing tendency the “Medusa Effect”, for it *petrifies* realities which are dynamic and structurally connected to other ones.

Aside from the division between implicit and explicit materialisms and that of between soft and hard materialisms, we could divide, inspired by Bunge (2010), all the branches of materialism into two main families: *exclusive materialisms* and *inclusive materialisms*. The first ones *exclude* the ontological reality of the psyche and concepts or ideas, whereas inclusive materialisms *include* them (although always emphasizing that such realities cannot exist without physical, chemical, and biological entities and processes: see Bueno 1972, Bunge 1977, Pérez Jara 2014, Romero 2018).

Exclusive materialisms can *exclude* the psyche and the ideas either by denying their very existence (such as “eliminative materialism” does), or by ontologically reducing such realities to entities and processes that are neither psychological nor abstract. Ontological reductions can be conducted in two different ways: downwards and upwards. This has been clearly seen by inclusive materialist philosophers such as Mario Bunge (with his criticisms of both individualism and holism: see Bunge 1996), and Gustavo Bueno (with his criticisms of illegitimate descendant reductionism and ascendant reductionism: see Bueno 1993). A similar analysis has also been done by philosophers who strongly oppose “materialism”. It is the case of Graham Harman’s interesting criticisms of the processes of undermining objects (reducing an object to its parts/components) and overmining objects (reducing an object to its effects/dynamisms). Graham (2013) has also criticized the combination of both ways of devaluing objects through a “duoming” process.

I do agree that both metaphysical phagocytizing of entities into supra-realities and metaphysical shredding into infra-realities are equally wrong. Both processes are blind to the complex interplay of the continuities and discontinuities that constitute reality. By hypostatizing either the whole/effects or the parts/individuals, they fall into the above-mentioned “Medusa Effect” so common in Western metaphysics when it gets astray from empirical investigation and good logical argumentation.

Physicalism is a perfect example of a reductionist/exclusive materialism. As such, it can be considered as a form of “vulgar materialism” (Bunge 2010; Bueno 1972). Despite its philosophical “vulgarity”, it has often ideologically kidnapped the term materialism. This offers a particularly useful straw man to those who oppose materialism, such as Markus Gabriel (2015, 2017), who identifies materialism with physicalism and thinks to have refuted it, happily ignoring inclusive forms of materialism which would make his job much harder.

Recently, a new philosophical movement has appeared under the name of “new materialisms” (Bennett 2010). This movement uses the term “materialism” at the same time that it criticizes physicalism. I do agree with thinkers such as Harman in that these “new materialisms”, despite their interest in some specific fields of analysis, represent another form of illegitimate reductionism, in this case upwards, as can be seen in their tendency to reduce everything to sociocultural effects, practices and dynamisms. I would go further: as long as these “new materialisms”

do not have strong ontological arguments against disembodied literal living beings, there is no reason to accept their self-invested title of materialism.

To conclude: current thinkers who identify materialism with reductionism may want to revise their too narrow view of materialism. Were they to consider inclusive materialisms, their criticism of materialism in general would no longer be valid. To criticize reductionism through reductionist concepts is more than a paradoxical methodology; it is a contradictory and therefore non-advisable philosophical practice. If these thinkers, though, continue to reject materialism in the general definition that I have proposed, they would have the burden of the proof of explaining how do they conceive the possibility of spirits, gods or ideas to subsist without physical, chemical, and biological matter.

13.3 Response (by Graham Harman)

In his rejoinder, “Materialism is Not False,” Javier Pérez-Jara agrees with my negative evaluation of “physicalism” as a philosophical position. As he puts it: “Physicalism is a perfect example of a reductionist/exclusive materialism. As such, it can be considered as a form of ‘vulgar materialism.’” Rather than stressing the serious problem that results from this concession—the difficulty of using the term “materialism” plausibly to refer to non-physicalist positions—Pérez-Jara uses it to turn the tables on the anti-materialists. By claiming to attack materialism while really just attacking materialism, he tells us, an anti-materialist like Markus Gabriel is only assaulting a straw man. What, then, is the true, non-vulgar materialism that Gabriel fails to dethrone? It seems to me that, in trying to make a case for non-vulgar materialism, Pérez-Jara mixes aspects of two entirely different doctrines, while claiming that they are merely the “positive” and “negative” faces of one and the same doctrine.

Let’s begin with “positive” materialism, which Pérez-Jara defines as follows: “positively, materialism, in general, names the branch of philosophical worldviews that identify *being* . . . with *matter*, understood in its broadest sense as changeability and plurality.” This is the closest thing we get to a definition of “matter” in the positive part of his materialism. Now, “plurality” is clearly not enough to do the job alone: the plurality of Plato’s forms clearly has nothing to do with materialism, since they are disembodied by definition, and Pérez-Jara makes no attempt to recuperate Plato as an ally. Nor would it be materialism if we had “changeability” without plurality. Certain pre-Socratic theories of the *apeiron* would fit the bill here, since there are several such theories that allow for constant change without making room for any genuine plurality. Another example would be Jane Bennett’s (2012, 227) materialism of a “throbbing whole” in which individual entities are in some sense derivative of this whole; Gilles Deleuze, who is one of Bennett’s primary inspirations, might also be read in this way. Thus we can see that Pérez-Jara’s materialist criterion of “changeability *and* plurality” most definitely requires a conjunction, and no theory will qualify that does not endorse both. But two counter-

examples immediately come to mind. Alfred North Whitehead's "actual entities" (1978) are obviously plural. They might not be considered "changeable," since they perish utterly from one instant to the next rather than merely changing (except in the derivative form of "societies"). But if this were enough for Pérez-Jara to deny their claim to perishability, this could only be on the basis of a hidden premise he never states: "materialism requires changeability *plus* some minimal endurance from one moment to the next." Bruno Latour (2007b) is a similar case to Whitehead, since his actors are definitely plural and also perish, since they can be called the "same" actors from one moment to the next only when another, eternal actor does work to show their equivalence between two separate moments of time. Yet Latour (2007a) is even more explicitly anti-materialist than Whitehead. Once again, Pérez-Jara could fend off this counter-example by requiring some sort of minimal endurance for actors to count as "matter." But this seems unlikely given his pronounced concern to emphasize dynamism: "Since, according to the legend, Medusa turned changing and dynamic realities into stone, I suggest to dub this hypostatizing tendency the 'Medusa Effect', for it *petrifies* realities which are dynamic and structurally connected to other ones." Indeed, one of Pérez-Jara's most negatively marked terms is "hypostasis," which emphasizes his commitment to dynamism all the more. Yet it is unclear why the affirmation of plurality plus dynamism requires anything like materialism (as the examples of Whitehead and Latour clearly show). Beyond this, it is unclear what degree of "structural connection" between entities is needed in order to avoid the gaze of Medusa, although Pérez-Jara now seems to be adding some sort of *relational* criterion to the mix.

This brings us to the "negative" side of Pérez-Jara's materialism, the only side that is materialist in any recognizable sense of the word. As he puts it: "Negatively, materialism denies the existence of disembodied living beings and hypostatized ideas." Now, most working mathematicians believe in disembodied ideas, though they would surely deny that this entails "hypostatizing" them in the negative sense of the term. Any materialist who wants to deny the existence of mathematical objects will need to give some sort of theory as to how such objects are ultimately "embodied." Pérez-Jara does not offer any such theory in his response, though in all fairness, we were asked to be brief in this exchange. The actual heart of his materialism seems to be this: "the psyche and concepts or ideas... cannot exist without physical, chemical, and biological entities and processes." Anyone who opposes this thesis, he claims, "would have the burden of the proof of explaining how [to] conceive the possibility of spirits, gods or ideas... without physical, chemical, and biological matter." I simply disagree as to where the burden of proof lies in this case. In the first place, we again hear no definition of "matter," which is fairly typical of materialist positions; it seems to be taken as the most obvious thing in the world. The world of cultures and languages surely arises from something more basic (or else we have "overmining," which I have criticized elsewhere, see Harman 2013). But what is this more basic stratum? If it has a specific character, then it is really made up of specific *forms* rather than "matter." And indeed, Pérez-Jara does specify what it is: physical, chemical, and biological matter. But this is where things really become unclear. Are these three separate kinds of matter, or one? It is the

question of the Trinity all over again! If we assume that they are just one kind, then presumably “physical” matter is the most basic, and we are back in the realm of physicalism, which Pérez-Jara claims to abhor. And if they are three separate kinds of matter, then unless we are dealing with a strange *ex nihilo* doctrine in which the chemical and the biological do not supervene on the physical at all—Meillassoux (2015) proposes a schema of this kind—then the chemical and the biological seem to be emergent realities irreducible to their more basic, physical constituents. But if the biological and the chemical are permitted such emergent reality, then it is not clear why the same cannot be done for the economic, the political, and the military. In conclusion, I fail to see the point of a materialism that does not bite the bullet of physicalism, and I have argued elsewhere in this volume that physicalism is wrong.

13.4 Response (by Javier Pérez-Jara)

In his engaging text, Graham Harman holds that my positive and negative definitions of materialism, instead of complementary, are two entirely different doctrines. I think that statement is totally inaccurate. From a logical point of view, materialism implies the identification between *being* and *matter*. This affirmation is reflected by my positive definition of materialism. On the other hand, materialism implies the denial of spiritualism and idealism. Such denial is expressed with my negative definition of materialism. Of course, the “positive” definition could be turned into a “negative” one (materialism as the ontology that denies the immutable and simple character of being), and the “negative” definition into a “positive” one (materialism as the ontology that affirms the bodily nature of every living being, along with the inexistence of ideas without some of these living beings). This does not change the fact that what materialism *is* is linked to what it *is not* and vice versa. My definition of materialism, as any ontological framework, relies on a particular theory of existence (Pérez Jara 2011, 2014). Although a discussion about this topic obviously transcends the scope of this brief debate, here it will be enough to point out to the fact that my approach distinguishes between different kinds of existence, so we can say that materialism denies the independent ontological existence of literal spirits and Platonic ideas, but not their conceptual existence. My philosophical materialism does not even deny the existence of the phenomenological experiences of the spiritualist mystic; what denies is the truth value of the mythological interpretation of such experiences.

Given the limited space we were provided for this discussion, it is also easy to understand that the positive criteria of “matter in its broadest sense” I gave is naturally a compressed summary of a metaphysical doctrine much larger (for that reason, it is also perfectly understandable that Harman wrote about materialism in this discussion without actually giving a single definition of “matter”). I would like to point out several important considerations here:

1. The general criteria of changeability and plurality allow for classic understandings of matter without falling into well-known anachronisms (such as the identifications between matter and mass, impenetrability, passivity, negativity, etc.).
2. That changeability and plurality are essential characteristics of matter in general does not imply that whatever has been understood by the mythological and metaphysical traditions as “changeable” and “plural” should be considered “material” (otherwise we could fall into the “affirming the consequent” logical fallacy). According to Buddha, for instance, the world is fundamentally changeable and plural. Despite these convergences with materialism as I have defined it however, Buddha cannot be considered a materialist thinker, if it is true that he held animist beliefs about spirits and reincarnation. The conclusion is obvious: there are several metaphysical doctrines on mutability and plurality, and not all of them are compatible with a materialist worldview. In the universe, changeability implies *energy*, and plurality a *complex interplay of continuities and discontinuities* (Bunge 1977, 2010; Bueno 1972; Pérez Jara 2014; Romero 2018). Plurality does not imply that everything real is composed of more basic components, like in some imagined “Lego–Fractal Ontology.” Let’s suppose, for the sake of the argument, that leptons or quarks do not have “parts.” Even if this were the case, they are not atoms in the classic Greek sense, but properties of material fields structurally connected with other material realities.
3. A scientifically supported ontological view on changeability and plurality is a *prerequisite* for a rigorous expulsion of disembodied spirits, gods, and Platonic ideas from reality. Naturally, Platonic ideas and ontotheology’s immutable and simple God are automatically excluded from the picture. On the other hand, changeable spirits (as postulated by exorcists and animists) violate the basic laws of thermodynamics and our well-grounded knowledge of cognitive neuroscience and evolutionary biology. Like dreams, a “dynamic (and maybe even democratic) society of spirits” is just a mosaic of distorted and contradictory images taken from our real material universe. Similarly, the rigorous knowledge we have about the genesis and structure of concepts and ideas necessarily imply that they are the products of long and complex human historical and sociocultural developments. This also applies to mathematics and logic: inclusive/non reductionist materialisms criticize both Platonism and radical formalism. As such, they take the rigor and clarity of mathematics and logic into account without postulating that mathematical and logical entities exist outside of human knowledge and manipulations (Bueno 1979a,b; Bunge 1985, Romero 2018; also see this book’s discussion section on the ontological status of mathematics). There is no false dilemma here between Platonism and a denial of the scientific character of mathematics.
4. Harman is completely right in that avoiding Medusa’s gaze is one of the key tasks for the inclusive materialism that I defend. But what are the necessary and suitable criteria, Harman asks, to know when something cannot be hypostatized? The answer is simple: *nothing*. The general characteristics of matter prevent the consideration of anything as an absolutely autonomous or immutable entity.

From electrons to galaxies, economic crises, to works of art and political systems, everything is changing and structurally connected to at least some other realities. Thus, when a property, relation, state, or event is treated as an entity, then it is under Medusa's gaze (for instance, thinkers who treat energy or structures as *entities*, instead of *properties*, hypostatize them; similarly, Christian Scholastics hypostatized "forms" by holding that they can exist without matter). So, even if change itself does not change, this does not mean that it can be hypostatized, for there is no change without changing realities. When a rigorous analysis of a given reality demonstrates that it *needs* other realities to exist, it means that it cannot be considered under Medusa's gaze. Thinkers who believe in the autonomous existence of psyches and ideas without biological, chemical, and physical entities and processes are, therefore, under Medusa's spell.

5. Finally, let's take the "multiple matters" issue into consideration. Harman asks about the ontological status of physical, chemical, and biological matter in my philosophy. In his words: "Are these three separate kinds of matter, or one? It is the question of the Trinity all over again!" My strong rejection of physicalism/vulgar materialism does not mean that there are things in the universe that can exist without a physical substratum. Against neophobic metaphysics, inclusive materialists such as Mario Bunge (1979) and Gustavo Bueno (1993) have used the concepts of *emergence* and *anamorphosis* respectively to explain the appearance of new realities irreducible to the components and processes from where they arise. Complex philosophical systems (such as Harman's OOO and the inclusive materialism I am defending) do not arise *ex nihilo*; they need complex sociocultural systems, which need individuals, who need biological matter, which need chemical components and reactions, which need physical entities and processes. Artificial and sociocultural realities however have qualitative properties that are *ontologically irreducible* to biological entities, just as biological entities are irreducible to chemical ones, which in turn are also irreducible to physical realities. Therefore, when Harman declares that "if the biological and the chemical are permitted such emergent reality, then it is not clear why the same cannot be done for the economic, the political, and the military." I could not agree more with him. I also guess that Harman will agree with me in that the world of politics, economics, and the military cannot exist without physical matter. Artificial matter, sociocultural systems, psyches, and so on, are not physical realities, but supraphysical ones (just as technology is supra-psychological and psychological life is supra-chemical: see Bunge 2010). Nevertheless, and unless we endorse radical constructivism, physical matter in general (even if epistemologically filtered or given to the human scale: see Bueno 2016) does not need artificial and sociocultural systems to exist. There are also good philosophical reasons to hold that physical matter, as we currently understand it, it is not an absolute $\acute{\alpha}\rho\chi\eta$, but a reality that has arisen from unknown ontological processes (Romero 2018; Bueno 2016; Pérez Jara 2014). It is important to note that ontological dependence does not mean lesser ontological weight: artificial and sociocultural matter is as real as the fields studied by physics, just as individuals are as real as the components and processes that

constitute them. Against radical ontological and epistemological monism, a physicist is totally unable to explain divorces or the Fall of the Roman Empire. Similarly, and despite the fact that societies and psyches necessarily imply a physical substratum, a psychologist or a sociologist is unable to explain quantum matter or spacetime.

To sum up: against the impoverishing views of vulgar materialists and spiritualists alike, matter presents many rich and irreducible ontological dimensions. Such plurality and richness are reflected by inclusive materialisms, whose philosophical virtues do not fit into the Procrustean bed of Harman's reductionist (and therefore simplistic) view of materialism.

References

- Aristotle. 1999. *Metaphysics*. Trans. J. Sachs. Santa Fe: Green Lion Press.
- Bennett, J. 2010. *Vibrant Matter: A Political Ecology of Things*. London: Duke University Press.
- Bennett, J. 2012. Systems and things: A response to Graham Harman and Timothy Morton. *New Literary History* 43:225–233.
- Berkeley, G. 1992. *A Treatise Concerning the Principles of Human Knowledge*. Indianapolis: Hackett.
- Boyle, R. 2008[1674]. *The Excellencies of Robert Boyle: The Excellency of Theology and The Excellency and Grounds of the Mechanical Hypothesis*. Peterborough: Broadview Press.
- Bryant, L.R. 2014. *Onto–Cartography: An Ontology of Machines and Media*. Edinburgh: Edinburgh University Press.
- Bueno, G. 1970. *El papel de la filosofía en el conjunto del saber*. Madrid: Editorial Ciencia Nueva.
- Bueno, G. 1972. *Ensayos Materialistas*. Madrid: Taurus.
- Bueno, G. 1979a. Operaciones autoformantes y heteroformantes. Ensayo de un criterio de demarcación gnoseológica entre la Lógica formal y la Matemática (I). *El Basilisco* 7:16–39.
- Bueno, G. 1979b. Operaciones autoformantes y heteroformantes ensayo de un criterio de demarcación gnoseológica entre la Lógica formal y la Matemática (II). *El Basilisco* 8:4–25.
- Bueno, G. 1993. *Teoría del cierre categorial*. Vol 5: *El sistema de las doctrinas gnoseológicas. Adecuacionismo. Circularismo* Oviedo: Pentalfa.
- Bueno, G. 2007. *La fe del ateo*. Madrid: Temas de Hoy.
- Bueno, G. 2016. *El ego trascendental*. Oviedo: Pentalfa.
- Bueno, G. 2019. *The Happiness Delusion. Debunking the Myth of Happiness*. Oviedo: Pentalfa.
- Bunge, M. 1977. *Treatise on Basic Philosophy*. Vol. 3: *The Furniture of the World*. Dordrecht: Reidel Publishing Company.
- Bunge, M. 1979. *Treatise on Basic Philosophy*. Vol 4: *Ontology II: A World of Systems*. Dordrecht: Reidel Publishing Company.
- Bunge, M. 1985. *Treatise on Basic Philosophy*. Vol. 7: *Epistemology & Methodology III: Philosophy of Science and Technology Part I: Formal and Physical Sciences*. Dordrecht: Reidel Publishing Company.
- Bunge, M. 1996. *Finding Philosophy in Social Science*. New Haven: Yale University Press.
- Bunge, M. 2010. *Matter and Mind: A Philosophical Inquiry*. New York: Springer.
- Carroll, L. 1993[1898]. *Alice's Adventures in Wonderland*. United States: Dover.
- Eddington, A.S. 1929. *The Nature of the Physical World*, New York: MacMillan.
- Gabriel, M. 2015. *Why the World Does Not Exist*. Cambridge: Polity.
- Gabriel, M. 2017. *I am Not a Brain: Philosophy of Mind for the 21st Century*. Cambridge: Polity.

- Harman, G. 2011. On the undermining of objects: Grant, Bruno, and radical philosophy. In *The Speculative Turn: Continental Materialism and Realism*, eds. L. Bryant, N. Srnicek, and G. Harman, 21–40. Melbourne: re.press.
- Harman, G. 2012. The third table. In *The Book of Books*, ed. C. Christov-Bakargiev, 540–542, Ostfildern: Hatje Cantz Verlag.
- Harman, G. 2013. Undermining, overmining, and duoming: A critique. In *ADD Metaphysics*, 40–51. J. Sutela, Aalto: Aalto University Design Research Laboratory.
- Kant, I. 1996. *Critique of Pure Reason*. Trans. W. Pluhar. Indianapolis: Hackett.
- Latour, B. 2007a. Can we get our materialism back, please? *Isis* 98:138–142.
- Latour, B. 2007b. *Reassembling the Social: An Introduction to Actor–Network Theory*. Oxford: Oxford University Press.
- Martin, M. 1989. *Atheism: A Philosophical Justification*. Philadelphia: Temple University.
- Martin, M., and R. Monnier. (eds.). 2003. *The Impossibility of God*. New York: Prometheus.
- Meillassoux, Q. 2015. Appendix: Excerpts from *L'inexistence Divine*. Trans. G. Harman. In *Quenting: Meillassoux: Philosophy in the Making*. Edinburgh: Edinburgh University Press, ed. by Graham Harman, 224–287.
- Ongay, Í. 2020. New (and Old) atheism(s) reconsidered. In *Atheism Revisited. Rethinking Modernity and Inventing New Modes of Life*, ed. by Szymon Wróbel and Krzysztof Skonieczny. New York: Springer.
- Pérez Jara, J. 2005. Materia y racionalidad: sobre la inexistencia de la Idea de Dios. *El Basilisco* 36:27–64.
- Pérez Jara, J. 2011. La importancia del cuerpo como “constitutivo formal” de todo viviente en la filosofía de Schopenhauer. *Thémata. Revista de Filosofía* 44:424–438.
- Pérez Jara, J. 2014. *La Filosofía de Bertrand Russell*. Oviedo: Pentalfa.
- Romero, G.E. 2018. *Scientific Philosophy*. Cham, Switzerland: Springer.
- Sellars, W. 2007. Philosophy and the scientific image of man. In *In the Space of Reasons*, 369–408. Cambridge: Harvard University Press.
- Whitehead, A.N. 1978. *Process and Reality*. New York: Free Press.
- Žižek, S., and D. Glyn. 2003. *Conversations with Žižek*. Cambridge: Polity.

Author Index

A

Abulafia, D., 28
Acuña, P., 166
Aeschylus, 23
Agar, J., 263
Agassi, J., xiii
Aikin, J.M.T., 38
Albertus Magnus (Albert the Great), 22, 25, 27
Alcmaeon of Croton, 211
Alexander, J.C., 110
Alexander, S., 135, 335
Alvargonzalez, D., 241
Anaximander, 4–7, 10, 23, 122
Anderson, J.L., 196
Anderson, P.W., 224
Andersson, L., 193
Anscombe, G.E.M., 149
Ansey, P.R., 35
Anthony the Great, 20
Aquinas, Th., 2, 19, 20, 22–25, 27, 144
Arabatzis, T., 240–242
Ariew, R., 178
Aristotle, 3, 8, 9, 11, 14–15, 21–23, 25–27, 30,
50, 55, 80, 94, 112, 122, 151, 216,
220, 350
Armstrong, D.M., 62, 63, 86
Ashtekar, A., 179, 192, 193
Ashworth, W.B., 29
Aspect, A., 160
Augustine of Hippo, 217
Auyeung, B., 219
Avicbron, 21
Avise, J.C., 219

Avital, E., 229
Ayala, F.J., 219

B

Baert, P., 110
Baggot, J., 98
Baird, D., 246
Baker, L.R., 222
Bakunin, M., 48
Barany, M., 329
Barkan, D.K., 248
Barnes, J., 6
Baron d'Holbach, 37, 57
Barrera, S., 68
Barrera-Osorio, A., 29
Barron, A.B., 230
Bauer, B., 54
Bauer, W., 16
Baumgarte, T.W., 184
Beck, G., 79
Beck, J.S., 42, 43
Beiser, F., 55
Bekenstein, J.D., 190
Bell, J.S., 156, 159, 165
ben Yehuda ibn Gabirol, S. (Avicebron), 21
Benacerraf, P., 270, 271
Benasich, A.A., 224
Bennett, J., 65, 66, 140, 353, 354
Bennett, K., 207
Bergliaffa, S.P., 179, 182
Bergmann, P.G., 184
Bergson, H., 208, 219, 225, 287, 335, 350

- Berkeley, G., 32, 35–37, 39, 40, 43, 45, 47, 60, 216, 220, 324, 350
- Beth, E.W., 80
- Bianchi, E., 191
- Bickle, J., 64
- Birrell, N.D., 170
- Bitol, M., 224
- Black, J., 57
- Blenkinsopp, J., 22
- Blitz, D., 91
- Boccia, M.L., 219
- Boethius, 24
- Bohr, N., 155, 156
- Boltzmann, L., 58, 247
- Borges, J.L., 36
- Born, M., 155
- Boscovich, R.J., 58
- Bourke, V.J., 21, 23
- Bowman, C., 45
- Boyd, R., 230
- Boyle, R., xi, 11, 33–35, 247, 254, 351
- Brakke, D., 19
- Brassier, R., 138, 143
- Broad, C.D., 334, 335, 342–344
- Broda, E., 58
- Brown, J.R., 276, 285, 290, 291
- Bruno, G., 20
- Bruno, G.A., 46, 47
- Bryant, L.R., 39, 139, 350
- Buchert, T., 193
- Büchner, L., 54
- Buddha, 7, 39, 118, 146, 357
- Bueno, G., 3, 80, 109, 217, 243, 272, 336, 352
- Bunge, M., 12, 79, 111, 156, 179, 199, 223, 250, 272, 304, 327, 335, 353
- Burgess, J., 324
- Buridan, J., 26
- Burt, E.A., 245
- Buss, L., 224
- Butterfield, H., 245
- Butterfield, J., 191
- C**
- Campbell, R., 219
- Camprubí, L., x, ix, xiv, 1–69, 239–263
- Canguilhem, G., 241, 242, 262
- Cañizares-Esguerra, J., 29
- Cao, T.Y., 58
- Carabine, D., 24
- Carfora, M., 193
- Carnap, R., 62, 251–253
- Carnot, S., 57, 58, 248
- Carroll, L., 352
- Carrera, M., 193
- Carroll, S.M., 191
- Carter, J., 298
- Cartwright, N., 86, 248, 252–254, 262, 336
- Case, T.I., 219
- Chalmers, D., 216, 221, 222, 229, 231
- Charles V, 28, 30
- Chemla, K., 3
- Childe, V.G., 62
- Chryssostom, J. (St.), 20
- Chryssavgis, J., 20
- Churchland, P.M., 63, 64, 123, 216, 221
- Churchland, P.S., 63, 64, 123, 216, 221
- Clark, S., 27
- Clarke, C.J.S., 186
- Clarke, S., 177
- Clauser, J.F., 160
- Clausius, R., 58
- Clifton, T., 190
- Coakley, J.W., 17
- Coley, A.A., 193
- Collins, H.M., 248
- Columbus, Chr., 28
- Combi, L., xiii, 172, 177–196
- Comte, A., 255
- Confucius, xii
- Conway, M.A., 219
- Cook, H., 247
- Coole, D., 66
- Coopmans, C., 246
- Copleston, F., 3
- Corfield, D., 272
- Coxon, A.H., 9
- Crick, F., 229
- Critchley, S., 23
- Crombie, A.C., 24, 245
- Crowe, M., 271, 272
- D**
- Dalibard, J., 160
- Dalton, J., 11, 27, 57, 254
- Damasio, A., 126, 229
- Darwin, Ch., 55, 59
- Daston, L., 27, 29, 242, 243
- David of Dinant, 20, 351
- Davies, P.C.W., 170, 171
- Davies, S., 28
- Davis, Ph.J., 271, 274, 277, 298
- Dawkins, R., 38, 232
- Day, J., 17, 22
- de Acosta, J., 28
- de Broglie, L., 155
- De Felice, F., 186

De Freitas, E., 275
 De Lorenzo, J., 272, 276, 277, 284, 285, 288, 299
 de Mariana, J., 29
 Dear, P., 247
 Dehaene, S., 229
 Dei Segni, L. (Pope Innocent III), 20
 Democritus, 7, 10, 15, 54, 211, 254
 Dennett, D.C., 38, 63, 64, 123
 Descartes, R., 31–33, 35, 37, 39, 40, 43, 47, 51, 119, 130, 216–220, 247, 270, 288, 297, 350
 Díaz Díaz, G., 21
 Dietzgen, J., 60
 Dionysius the Areopagite, 24
 Dirac, P.A.W., 155, 297
 Dorn, G.J.W., 81
 Du Bois-Reymond, E., 233
 Du Bois-Reymond, P., 124, 295
 Duhem, P., 244, 245, 256
 Dunn, G.D., 17
 Duns Scotus, 39
 Dupré, J., 65, 135, 230, 250, 251
 Dutreuil, S., 261

E

Earman, J., 162, 191
 Eccles, J., 63, 220
 Echeverría, J., 29, 304
 Eckart, C., 162
 Eco, U., 303, 304
 Eddington, A.S., 350
 Edgerton, S., 247
 Edwards, P., 258
 Einstein, A., 58, 59, 83, 95, 99, 115, 155, 158, 159, 172–174, 178, 180–182, 186, 191–193, 254, 284, 296
 El-Hani, Ch., 223
 Ellis, G.F., 191, 193
 Emmeche, C., 223
 Empedocles, 10, 11, 13, 122
 Engels, F., 39–57, 60, 61, 110, 121, 342–34
 Ennis, P.J., 138
 Epicurus, 15, 17, 30
 Esfeld, M., 179
 Estes, Y., 45
 Euripides, 23

F

Fagenblat, M., 24
 Fahrbach, L., 149
 Faraday, M., 58, 166, 187, 339

Farrington, B., 245
 Feest, U., 242
 Feigl, H., 221
 Feingold, M., 28
 Feldman, M.W., 229
 Feldman, R., 219
 Fernández de Oviedo, 29
 Ferreirós, J., x, 245, 251, 272
 Feuerbach, L., 9, 55
 Feynman, R.P., 156, 157, 308
 Fichte, J.G., xii, 39, 40, 43–51, 55, 56, 60, 125
 Figuerola, C.G., 317
 Fitness, J., 219
 Fleck, L., 245
 Floridi, L., 304
 Fock, V., 62, 167–169
 Fodor, J., 223, 334, 342
 Franklin, A., 245
 Franssen, M., 304
 Frauenstädt, J., 54
 Freedman, S.J., 160
 Freeman, C., 16, 18, 19, 21, 307
 Frege, G., 221, 270, 273, 290, 331
 Friedman, M., 137, 196, 241
 Frost, S., 66

G

Gabriel, M., 65, 123, 149, 150, 227, 229, 353, 354
 Galen, 37, 204, 211
 Galileo, 26, 28, 30–33, 130, 177, 247, 296
 Galison, P., 242, 254
 Ganguly, K., 228
 García Valverde, J.M., 30
 Garon, J., 64
 Gassendi, P., 11, 33, 122, 247
 Geest, P.V., 24
 Gell-Mann, M., 134
 Giaquinto, M., 286, 290
 Gibbs, J.W., 58
 Giere, R., 240
 Gillispie, C.C., 241
 Gilson, E.H., 21–23
 Ginsburg, S., 224, 230–232
 Ginzburg, V., 62
 Gitelman, L., 258
 Giulini, D., 193–195
 Godfrey-Smith, P., 231
 Goetschel, W., 46
 Goldstine, H.H., 308
 Gómez Pereira, A., 30, 31, 51
 González del Solar, R., xiii, 199–213
 Goodman, N., 324

- Goodwin, C., 257
 Grafton, A., 28, 29
 Graham, D.W., 5–7, 63
 Gramsci, A., 32
 Grangier, P., 160
 Grant, E., 25
 Gray, J.J., 272
 Green, S.R., 193
 Gregory, F., 55
 Griffin, D., 231
 Grosseteste, R., 24, 25
 Groves, T., 317
 Gutas, D., 21
- H**
- Haaparanta, L., 15
 Hacking, I., 240, 242, 246, 252, 253, 260, 269,
 270, 276, 284, 287, 298
 Hadamard, J., 272, 284
 Hahn, H., 256
 Hamblin, J.D., 257
 Hameroff, S.R., 231
 Hanson, N.R., 240, 245, 247
 Harkness, D.E., 247
 Harman, G., xiv, 39, 65, 66, 135, 138–140,
 249, 250, 349–359
 Harré, R., 87
 Harris, M., 62, 125
 Harris, S., 38
 Harrison, P., 38, 111
 Hartimo, M., 272
 Hatfield, G., 241
 Hebb, D.O., 93
 Hecht, G., 249
 Hegel, G.W.F., 2, 8, 39, 40, 46–51, 55–57, 60,
 125, 133, 148, 216, 232, 344
 Heidegger, M., 40, 48, 52, 59, 116, 138–140,
 142, 144, 148, 149, 245, 256, 350,
 352
 Heil, J., 81, 92
 Heine, H.E., 273, 331
 Heisenberg, W., 79, 155, 156, 162–164, 173,
 297
 Heller, M., 185
 Helmholtz, H. von, 54, 58, 247, 248
 Helmreich, S., 257
 Helvétius, C.A., 37
 Hempel, C.G., 62, 245
 Henry, J., 30, 228
 Hersh, R., 271, 272, 274, 277, 298
 Hesiod, 4, 9, 10, 17, 23
- Hesse, M.B., 58
 Hessen, B., 245
 Hevia Echeverría, J., 29
 Hidalgo, A., 68
 Hilbert, D., 80, 160, 162, 167, 173, 270, 277,
 280, 281, 322, 325, 326, 328–330
 Hippocrates, 37, 211
 Hitchens, Chr., 38
 Hobbes, T., 17, 29, 30, 33, 37, 38, 113, 122,
 351
 Hobson, A., 97, 171
 Hofer, C., 178, 182
 Honko, L., 127
 Hospers, J., 149
 Howard, D., 178
 Huerga, P., 248
 Huerta Martín, F., 80
 Huggett, N., 178, 182
 Humboldt, A. von, 48
 Hume, D., 32, 35–37, 39–41, 65, 118, 125,
 128, 132, 216, 228, 252, 255
- I**
- Iftime, M., 183
 Ihde, D., 246
 Ingold, T., 250, 252
 Innocent III, 20
 Irvine, A.D., 273
- J**
- Jablonka, E., 224, 229–232
 Jackson, F., 221
 Jacob, M., 34
 Jacobi, F.H., 45, 46
 Jaeger, W., 3, 23
 James, C.L.R., 55
 James, W., 61, 63, 228
 Jammer, M., 95, 156, 178
 Janet, P., 53
 Janssen, M., 182
 Jarochevski, M., 61
 Jerome (St.), 20
 Jesus Christ, 16, 19
 Joachims, T., 317
 John the Baptist, 20
 Johnston, W., 38
 Johnston, W.M., 20
 Joker, 150
 Jordan, P., 155
 Josephson-Storm, J., 46
 Justin Martyr (St.), 18

K

Kahn, C.H., 5, 6, 8
 Kant, I., 32, 39–47, 49–54, 116, 119, 120, 122,
 125, 137, 140, 270, 284, 350
 Kars, A., 24
 Kepler, J., 31, 254, 297
 Khavkine, I., 185
 Kierkegaard, S., 48
 Kirk, G.S., 5, 6
 Kirk, R., 223
 Kirsch, J., 13
 Kitcher, Ph., 272, 275, 286, 296, 299
 Klein, C., 231
 Klein, J., 29
 Kleinert, H., 193
 Kline, R., 245
 Kojevnikov, A., 62
 Kolb, E.W., 193
 Komar, A.B., 184
 Korzyński, M., 193
 Koskinen, H.J., 15
 Kostro, L., 95
 Koyré, A., 245
 Kraus, L., 231
 Kripke, S., 221, 231
 Kuhn, T.S., 241, 245, 247, 248

L

La Mettrie, J.O. de, 37, 38, 122
 Ladyman, J., 83, 132, 179
 Lakatos, I., 241, 271
 Lakoff, G., 286
 Laland, K., 229
 Lam, V., 179
 Lamb, M.J., 229
 Landau, L.D., 62, 189
 Lange, F., 54, 55
 Lao Tse, 36
 Latour, B., 66, 136, 140, 232, 242, 248, 249,
 275, 276, 284, 296, 298, 345, 350,
 355
 Laudan, L., 241
 Lavoisier, A.-L. de, 27, 57, 58
 Lawler, D., 305, 306
 Lehmkuhl, D., 99, 186
 Leibniz, G.W., 34, 39, 45, 65, 95, 102, 127,
 132, 148, 149, 177, 178, 216, 219,
 274, 328
 Lenin, V.I., 60, 61
 Leshner, J.H., 9
 Lessing, G.E., 46
 Leucippus, 10
 Levine, J., 216

Lewis, D., 221, 228
 Lewis, P.J., 156
 Lindberg, D.C., 25
 Livingston, E., 269, 275, 284
 Locke, J., 34, 35, 41, 216
 Logan, I., 311
 Lokhorst, G.-J., 304
 Long, A.A., 5, 16
 Long, P.O., 247
 López Armengol, F., 165
 Lopez de Casenave, J., 202
 Loraux, N., 23
 Lorentz, H., 59, 95, 166
 Lucretius, 17, 30, 54, 335
 Lunbeck, E., 242
 Luther, M., 18, 23, 39, 46

M

Maartens, R., 191
 MacCallum, M.A., 191
 MacCulloch, D., 17
 Mach, E., 58, 61, 182, 244, 245, 256
 Machiavelli, N., 27
 MacKenzie, D., 329
 MacLane, S., 286
 MacMullen, R., 16
 MacWhinney, B., 224
 Maddy, P., 271
 Madrid Casado, C.M., xiv, 128, 269–299,
 321–332
 Mahmut, M.K., 219
 Mahner, M., 90, 201, 204, 208, 209
 Maimon, S., 42, 43
 Mainländer, P., 97, 98
 Malafouris, L., 246
 Malament, D.B., 180, 185
 Malebranche, N., 32, 39, 51, 115, 219
 Mancosu, P., 272, 286, 292
 Manders, K., 246, 276, 288, 294
 Margenau, H., 156
 Marone, L., 202
 Marquis, J.P., 81, 273–275, 328
 Marra, M.F., 141
 Martin, M., 143, 352
 Martin, R.M., 80
 Martino, A.A., 67
 Marx, K., 15, 39–57, 60, 80
 Mary of Egypt, 20
 Matthews, M.R., 67, 81
 Maturana, H.R., 223
 Maxwell, J.C., 58, 59, 160
 Maxwell-Stuart, P., 30
 May, G., 22

Maynard Smith, J., 224, 230, 232
 McClendon, J.H.III., 56
 McKirahan, R.D., 5
 McLaughlin, B., 207
 McMullin, E., 241
 Meillassoux, Q., 65, 66, 138, 139, 147, 356
 Meli, D.B., 30, 33, 247
 Melissa of Samos, 10
 Merwe, A. van der, 58
 Messiah, A., 165
 Meyerson, E., vii
 Midwinter, C., 182
 Minh Nguyen, A., 141
 Misner, C.W., 178, 187
 Molle, L.V., 20
 Monnier, R., 143, 352
 Morgan, C.L., 135, 225, 335
 Morhenn, V., 219

N

Nagel, Th., 216, 221, 225, 229
 Nebe, G., 18
 Nerlich, G., 63
 Nestle, W., 4
 Netz, R., 3, 246, 269, 275, 276, 283, 285, 286,
 288, 294, 296
 Neumann, J. von, 155, 163, 271, 297, 308
 Neurath, O., 62
 Newman, W., 27, 28, 247
 Newton, I., 33, 35, 102, 177, 178, 248, 274,
 288, 297, 329
 Nicholson, D.J., 65
 Nietzsche, F., 38
 Norsen, T., 156
 North, J., 12
 Núñez, R.E., 286

O

Occam, W. of, 39
 O'Connell, J., 248
 O'Connor, T., 204
 Odling-Smee, F., 229
 Ongay de Felipe, Í., 215–234, 333–346
 Oparin, A., 209
 Orgel, L.E., 231, 232
 Origen of Alexandria, 17
 Oriti, D., 173
 O'Rourke, F., 24
 Osler, M.J., 245
 Ostrowski, J.J., 193
 Ostwald, W., 58
 Otto, R., 145

P

Padgen, A., 28
 Papandrea, J.L., 16, 19
 Paracelsus, 27
 Pardo, J., 29
 Parkin, A.J., 219
 Parmenides, 9–12, 22, 47, 51, 121, 122, 135,
 136, 185
 Parrilla, G., 262
 Parsons, C., 271
 Pascal, B., 34
 Pasternack, L., 42
 Paul the Apostle, 20
 Pauli, W., 155
 Peck, J., 8
 Pedersen, C.A., 219
 Peeters, E., 20
 Peirce, Ch.S., 269, 279, 281, 282, 284, 285,
 293, 295, 296
 Peitgen, H.O., 314
 Peña, V., 34
 Penrose, R., 190, 231, 296
 Perez-Bergliaffa, S.E., 95, 160, 164
 Pérez-Jara, J., x, xiv, xiii, 1–69, 80, 109–151,
 229, 250–252, 333–346,
 349–359
 Philipp II, 30
 Philoponus, J., 26
 Pickering, A., 246
 Pimentel, J., 29
 Place, U.T., 62, 211, 221
 Plato, xii, 2, 7, 8, 10–13, 19–21, 23, 94, 127,
 132, 146, 148, 216, 217, 270,
 354
 Poel, I. van, 304
 Poincaré, H., 142, 149, 168, 171, 256, 272,
 277, 286, 287, 293
 Poisson, E., 188
 Polger, Th., 223
 Pølya, G., 271
 Pomponazzi, P., 27, 30
 Pons, J.M., 184
 Poo, M.M., 228
 Popper, K., 43, 49, 63, 129, 240, 241, 245, 262,
 298, 304
 Porter, T., 247
 Portuondo, M., 28
 Price, H., 63
 Primero, G., 68
 Pseudo-Dionysius the Areopagite, 24
 Purrington, R.D., 58
 Putnam, H., 223, 231, 270
 Pythagoras, xii, 127, 217, 254, 299

Q

Quine, W.V.O., 216, 242, 270, 324, 325
 Quintanilla Fisac, M.Á., 303–318

R

Ramsey, W., 64
 Randall, J.H. Jr, 63
 Rankine, W., 58
 Räsänen, S., 193
 Raven, J., 5, 6
 Raw, G., 58
 Raymond of Sabunde, 21, 24
 Reinhold, K.L., 42, 43
 Remes, P., 19
 Resnik, M., 271
 Rheinberger, H.J., 241, 254
 Ribary, U., 224
 Richerson, P.J., 230
 Richter, P.H., 314
 Roberts, L., 247, 249
 Robinson, Th.A., 20
 Rocca, G.P., 24
 Rochd, I., 22
 Rodrigues, H.P., 20
 Roger, G., 160
 Rogers, A.J., 35
 Romero, G.E., x, ix, xiv, xiii, 1–69, 79–105,
 111, 124, 128, 143, 155–174, 178,
 179, 183, 185, 186, 199, 242, 272,
 274, 278, 297, 321–332, 353, 357,
 358
 Rorem, P., 24
 Rorty, R., 63, 112
 Rosen, G., 324
 Rosental, M., 61
 Rosenzweig, M.R., 219
 Ross, D., 83, 132
 Rotman, B., 269, 276, 284, 285
 Roukema, B.F., 193
 Rovelli, C., 180, 183, 191, 195
 Rowlands, M., 249
 Ruetche, L., 166
 Ruiz Mirazo, K., 224
 Russell, B., 43, 46, 49, 50, 52, 61, 142, 216,
 220, 240, 270, 328
 Ryle, G., 221
 Rynasiewicz, R., 181

S

Sacristán, M., 110
 Sander, L.M., 315
 Santiago, J., 189

Sargon of Akkad, 124
 Sawyer, K., 224
 Schaffer, J., 99
 Schaffer, S., 33, 247, 248
 Scheler, M., 140
 Schelling, F. W. J., 39, 40, 44, 46–53, 56, 125,
 149, 232
 Schofield, M., 5, 6, 223
 Schopenhauer, A., xii, 30, 39, 40, 43, 47, 49,
 51–54, 59, 122, 123, 125, 138, 147,
 149
 Schröder, E., 281
 Schrödinger, E., 155, 162, 231, 297
 Schulze, G.E., 42, 43, 53
 Searle, J.R., 63, 221–223, 227, 228
 Sellars, R.W., 65, 80, 93, 95, 104, 337
 Sellars, W., 350
 Serfati, M., 329
 Seth, S., 247
 Sextus Empiricus, 130, 232
 Shapere, D., 241
 Shapin, S., 33, 241, 247
 Shapiro S.L., 271
 Sheehan, Th., x, 59, 138, 142
 Silberstein, M., 80
 Silk, J., 98
 Simeon Stylites, 20
 Sinclair, N., 275
 Slaveva-Griffin, S., 19
 Smart, J.J.C., 62, 63, 93, 211, 221
 Smeenk, C., 95
 Smith, C., 54, 254
 Smith, P. H., 27, 247
 Smolin, L., 98, 184
 Snyder, C.W., 224
 Sober, E., 220, 221
 Soete, L., 307
 Sophocles, 23
 Sorabji, R., 95
 Sperry, R. W., 227
 Spinoza, B., xii, 30, 34, 37, 38, 46, 49, 50, 59,
 122, 148, 216, 337, 351
 Spurrett, D., 132
 Stachel, J., 179, 181, 183
 Stalin, J., 61
 Stephen, I. D., 219
 Stevenson, R. J., 219
 Stich, S., 64
 Stilwell, J., 287
 Strauss, D.F., 54
 Strawson, P., 40
 Striedter, G.F., 219
 Strum, S. C., 241
 Sturm, T., 242

Suárez, F., 28
 Suárez, M., 251
 Szabó, L.E., 273
 Szathmáry, E., 224, 230, 232

T

Tavakol, R., 190
 Taylor, C.C.W., 10
 Tegmark, M., 295, 296
 Teixidó, O., 103
 Tertullian, 17
 Thales of Miletus, vii
 Theodosius I, 16
 Thiry, P.-H. (Baron d'Holbach), 37
 Thomae, J., 273
 Thomasson, A., 101
 Thompson, J.J., 58, 59
 Thomson, A., 37
 Thomson, W. (Baron Kelvin), 58
 Thorne, K.S., 179, 187
 Thurston, W.P., 328
 Tilley, C., 250
 Turing, A.M., 306, 308, 314

U

Unruh, W. H., 170, 171
 Unzicker, A., 98

V

Vaihinger, H., 80, 101
 Van Melsen, A.G., 58
 Vapnik, V. N., 317
 Varela, F.J., 224
 Vega, J., 305
 Vermeir, K., 27
 Visser, M., 189
 Vogt, C., 54
 Voltaire, 34
 von Hartmann, K.R.E., xii, 47
 von Neumann, J., 163, 271, 297, 308
 Vucetich, H., 95

W

Wahlde, U.C. von., 19
 Waismann, F., 283
 Wald, R. M., 188, 193, 194
 Wallace, D., 190

Wallis, R.T., 19
 Wang, P.Y.-Z., 81
 Watt, J., 57, 306
 Weber, B., 208
 Weber, M., 26
 Weeks, A., 27
 Weidemann, H.U., 20
 Weingartner, P., 81
 Werrett, S., 247
 West-Eberhard, M. J., 228
 Westfall, R.S., 33, 34
 Weyl, H., 96, 172, 178, 184, 297
 Wheeler, J. A., 99, 173, 178
 Whewell, W., 38
 White, L.A., 62
 Whitehead, A.N., 350, 355
 Wigner, E.P., 156, 296
 Wildberger, N.J., 273
 Willis, Th., 35
 Wils, K., 20
 Wiltshire, D.L., 193
 Wise, M. N., 54, 248, 254, 261
 Wittgenstein, L., 139, 256, 269, 283, 326
 Woit, P., 98
 Wolff, Chr., 51, 115, 121
 Wollett, K., 219
 Wolman, D., 227
 Wong, H.Y., 204
 Woods, J., 101
 Wooton, D., 28
 Wunsch, C., 262

X

Xenophanes, 7, 9, 125

Y

Yaldabaoth, 19
 Young, F., 22
 Yourgrau, W., 58
 Yudin, P., 61

Z

Zelazo, P.R., 224
 Zeldovich, Y., 62
 Zeno of Elea, 10
 Žižek, S., 55, 350
 Zubiri, X., 142

Subject Index

A

Abgrund, 52, 149

Absolute

reality, 36, 40, 41, 44, 46, 49, 51–53, 59, 65, 112, 117, 120–122, 130, 131, 137–139, 141–143, 147, 150, 255, 256

Action, 14–16, 30, 33, 43, 58, 59, 68, 86, 102, 129, 159, 165, 195, 202, 203, 230, 261, 277, 283, 286, 297, 305–307, 309, 314

Ad infinitum, 60, 132

Adjustment, 81, 120, 130, 131, 258, 306

ADM mass, 188, 189

Affine connection, 180, 187, 194

Aggregate, 15, 36, 83, 90, 92, 93, 118, 132, 201, 224

Algebra, 102, 167, 168, 276, 280–282, 286, 288, 293, 297–299, 310, 322, 324, 326

Algorithm, xiv, 292, 303, 304, 307–314, 317, 318

Allegorism, 17, 18

Anamorphosis, 135, 229–234, 358

Ancién regime, 125

Animal, xiv, 5, 22, 30, 31, 51, 53, 56, 61, 90, 94, 100, 102, 112, 116–121, 126–130, 132, 137, 139–145, 147, 150, 151, 202, 212, 216, 219, 221, 223, 228–231, 248, 255, 260, 261, 304, 327

Animism, 29, 42, 60, 62, 65, 66, 125, 127, 136, 140, 228, 352

Anthropic

filtering, 117, 137–142

principle, 116, 243, 295

reality, 120, 243, 252, 253, 255, 256

universe, 115–119, 134

world, 116, 120, 137, 141, 255, 258

Anthropocene

anthropogenic change, 261

Anthropomorphism, anthropomorphic, 4, 8, 9, 13, 17, 18, 24, 34, 111, 114, 144, 146, 352

Apeiron, 4–6, 23, 122, 354

Apophatic, 24, 142, 144

Apothetic, 129

A priori, 40, 49, 51, 53, 102, 120, 124, 164, 241, 273, 281, 295, 327

Arche, 5

Aristotelian, 3, 16, 18, 22, 25–28, 31, 32, 35, 51, 246, 247, 252

Artifact, 2, 101, 103–105, 117, 118, 124, 128, 129, 136, 222, 246, 247, 262, 263, 272, 274, 295, 297, 304, 305, 325–330

Artificial intelligence (AI), 69, 93, 151, 223, 316, 317

Astronomy, 12, 111

Ataraxia, 15

Atheism

essential, 143

existential, 38, 143

ontic, 143, 145

ontotheological, 143

- Atoms**
 atomic, 58, 90, 156, 203, 297, 339
 atomic theory, 27, 57, 58
 atomism, 27, 35, 38, 55, 254
- Axiom**
 axiomatics, 147, 160, 164, 181, 277, 328
 axiomatization, 79, 160, 164, 165, 328
- B**
- Becoming**, 6, 36, 45, 50, 185, 186, 204, 249, 250, 274, 344, 350
- Behaviorism**, 63, 221
- Being**
 beingness, 149
- Bell's theorem**, 159
- Big bang**, 136, 173, 191
- Binary logic**, 127, 145, 352
- Biology**, xiii, 37, 38, 41, 53, 54, 59, 65, 66, 93, 110, 126, 130, 199–213, 216, 223, 228, 230, 232–233, 251, 256, 260, 299, 335, 342, 357
- Biosystem**, xiii, 134, 137, 151, 208–210, 213
- Black Death**, 26
- Black hole**, 69, 96, 170, 173, 184, 187–191, 193
- Brain**, 35, 37, 51, 53, 62–64, 90, 93, 94, 100, 103, 105, 119, 123, 126, 129–131, 140, 210–212, 216, 218–223, 227–231, 273, 280, 292, 295, 312, 314, 330, 344, 350
- Buddhism**, 36, 51, 141, 144, 148
- Bundle theory**, 36, 118, 228
- C**
- Calculate**
 calculation, 191, 258, 269, 276, 277, 292, 295, 297, 303, 306, 308–310, 313, 317
- Calculus**, 160, 290, 299, 307
- Cartesian**, 34, 35, 54, 220–222, 224, 227, 231, 298
- Cataphatic**, 24, 142
- Categorical closure**, 67, 253, 257
- Categories**, 14, 40–42, 49–51, 53, 60, 68, 69, 81, 117, 120, 122, 124, 138, 140, 181, 216, 217, 226, 230, 241, 248, 253, 257, 274, 336, 338
 categorical, 67, 221, 233, 253, 257, 263, 282
- Causality**, 30, 34, 36, 38, 39, 41, 48, 49, 52, 53, 63, 66, 79, 111, 112, 148, 165, 228, 249, 306, 338, 339
- Cause**, 3, 5, 7, 14, 22, 23, 26, 29, 31, 32, 35, 36, 40, 52–54, 63, 94, 120, 148, 162, 228, 251, 346
- Change**
 changeability, xiii, 2, 69, 121, 137, 146, 147, 186, 272, 351, 354, 355, 357
- Chaos**
 chaotic, 11, 13, 22, 23, 341
- Chemistry**, 27, 37, 41, 57, 63, 66–68, 86, 110, 133, 203, 209, 226, 232, 261, 278, 295, 299, 321, 340, 344
- Chorismos**, 150
- Christianity (Christian theology)**, 16–23, 25, 37, 39, 42, 59, 64, 248
- Codetermination**, 117, 139, 146
- Cognition**
 cognitive, 64, 80, 126, 129, 221–223, 228, 275, 276, 286, 325, 326, 357
- Complex**
 complexity, 23, 38, 46, 59, 69, 88, 90–92, 105, 114, 126, 151, 178, 184, 216, 224, 225, 227, 230, 316, 327, 333–335, 343
- Composition**, 11, 30, 80, 88–92, 99, 130, 134, 185, 201, 203, 208, 209, 224, 261, 305, 334, 346
- Computationalism**, 31
- Computer**
 computing, 304, 306–309, 311, 313, 314, 317, 318
- Concepts**
 conceptual, 2, 65, 69, 81–83, 85, 87–89, 100–105, 113, 117, 121, 128, 173, 184, 199, 201, 218, 243, 248, 252, 272–274, 278–280, 297, 304, 306, 317, 322, 325–330, 332, 352, 356
- Conscious**
 consciousness, xii, 8, 39–42, 44, 45, 47–49, 51, 56, 57, 60, 63, 119, 121, 125, 126, 140, 156, 163, 211, 216, 221, 222, 224, 228–233
- Constructivism, constructionist**, 68, 136, 150, 242, 247, 249, 259, 273, 277, 341, 345, 358
- Contingency**, 23, 40, 65, 118, 120, 258, 351
- Contingentism**, 36, 39, 65
- Continuity**, 13, 67, 101, 113, 129–133, 141, 146, 147, 150, 224, 246, 250,

- 251, 255, 256, 258, 259, 263, 334,
336–342, 344, 345, 353, 357
- Continuum, 27, 99, 134
- Conventionalism, 128, 330
- Corporeal, corporeity, xii, 21, 30, 59, 113, 118,
130, 150, 220, 225, 270, 276, 279,
281, 284, 291, 295, 321, 323
- Corpurcularism, 33
- Correlationism, 137–142
- Cosmological constant, 191, 192
- Cosmology, xiii, 5, 14, 116, 128, 178, 191–194,
335
- Cosmos, x, 4, 5, 7, 23, 140, 296
- Covariance, 86, 195
- Creatio ex nihilo*, 22, 135, 140, 141, 225, 226,
234, 337
- Creationism, 21, 22, 24, 47, 342
- Cryptomaterialism, 37, 38
- D**
- Data, 40, 69, 100, 120, 245, 257, 258, 262,
308–313, 317
- Dator formarum*, 27, 39, 125, 252
- Demiurge, 13, 19, 22, 40, 125, 295
- Descriptive/normative, 54, 110, 240, 260, 328
- Determinism, 38, 114, 162, 249
- Deus absconditus*, 24, 50, 116, 122, 141, 144
- Deus revelatus*, 116
- Diagrams, 203, 246, 248, 254, 257, 258,
261, 263, 274, 275, 277, 279, 281,
283–288, 290, 293–296, 328, 329
- Dialectics, dialectical, 39–57, 60, 61, 110, 112,
279, 344, 351
- Diamat*, 60, 61, 133
- Diffeomorphism, 180, 184, 195
- Digital, 262, 292, 306, 308, 309, 311, 312, 317,
318
- Discontinuity, 13, 15, 50, 56, 61, 67, 113, 117,
121, 129–137, 141, 144, 146, 147,
150, 224, 227, 250, 251, 253, 255,
256, 335–341, 343–346, 353, 357
- Disembodied living beings, xii, 2, 146, 147,
352, 355
- Divine, 3, 8, 15, 21–24, 37, 38, 42, 45, 48, 54,
125, 132, 135, 144, 145, 149, 219,
233, 351, 352
- Divinity, 18, 49, 52, 127, 143–145
- DNA, 208, 210
- Doctrine of the Three Genera of Materiality,
129
- Double slit experiment, 157, 158
- Dualism, 12, 13, 42, 47, 49, 61, 63, 64, 133,
211, 216–221, 223–228, 230, 234
- Dynamic
dynamical equations, 158, 160, 162, 174
realities, 146, 353, 355
- E**
- Ego
transcendental, 67, 113
- Einstein's equations, 182, 186, 191–193
- Electron, 79, 82, 97, 132, 157, 158, 185, 225,
242, 246, 253, 281, 324, 325, 358
- Electronic
circuits, 308–314
- Eliminativism, 62, 63, 65, 216
- Emergence, 10, 80, 125, 193, 200, 223, 270,
334, 350
- Empiricism
empirical, 4, 5, 8, 11, 23, 24, 35, 37, 40–44,
58, 62, 69, 97, 100–102, 118, 124,
131, 221, 222, 226, 241, 244, 251,
269–271, 273–276, 281, 282, 292,
296, 299, 321, 325, 327, 353
- Emptiness, 36, 148
- Energy
energy-momentum, 83, 170–172, 180, 186,
187, 192
- Entanglement, 159, 165, 166, 173, 174
- Entities, 2, 81, 113, 160, 178, 200, 216, 244,
271, 304, 321, 350
- Entropy, 58, 83, 90, 99, 178, 189–191, 248
- Environment
environmental sciences, 239, 244, 261, 262
- Epicureans, 11, 15, 18, 21, 37
- Epidemiology, 260
- Epistemology, ix, xiii, 8, 23, 35, 37, 40, 43, 60,
61, 67, 68, 80, 100, 201, 241–243,
246, 249, 256, 258, 276, 340–342
- Essence, 7, 10, 12, 13, 23, 36, 48, 135, 143,
180, 218, 241, 251, 272, 273, 293,
306, 350
- Essentialism, 127, 133, 251
- Ethics, 15, 18, 37, 51, 60, 68, 105, 201
- Ethology, 216, 219, 230
- Events, 7, 42, 61, 63, 86, 96, 113, 118, 124,
138, 158, 164, 165, 170, 178,
182–183, 186, 211, 222, 223, 228,
338, 346, 352, 358
- Evolution, 2, 5, 18, 47–50, 59, 82, 87, 89, 136,
140, 161–164, 174, 178, 184, 185,
207, 210, 213, 224–232, 308, 335,
339, 340
- Existence
mode of, 199, 325
- Existential angst, 151

Ex nihilo, 4, 5, 13, 17, 22, 40, 135, 140, 141,
144, 225, 226, 234, 335, 337, 342,
356, 358

F

Facts, 5, 98, 118, 160, 200, 255, 270, 346
False dilemma, xi, 64, 123, 225, 342
Family resemblance, 334
Fiction
 fictionalism, 101, 103, 271, 272, 274, 275,
 278, 329
 fictionism, 274, 275
Fideism, 17, 18
Field, 21, 86, 111, 160, 178, 200, 216, 225,
 271, 321, 339, 351
Filters, 116, 117, 121, 137, 140–142
Force, 3, 11, 26, 29, 51–55, 58, 60, 113, 117,
 145, 170, 172, 180, 186, 187, 208,
 247, 248, 306, 335
Formal
 formalism, 79, 102, 155–157, 160–163,
 166, 179, 183, 189, 225, 270, 273,
 277, 331, 357
 formless matter, 279
 sciences, 101, 244, 260, 269, 270, 273, 275,
 276, 281, 323, 324
Foundation, foundationalism, xiv, 27, 41, 43,
 79, 92, 144, 156, 178, 181, 270–272,
 274, 277, 327, 328
Franciscan, 25
Freedom, 23, 42, 44, 47–49, 52, 111, 112, 184,
 190, 325
Functionalism, 134, 144, 216, 222–226, 234

G

General relativity (GR), vii, 59, 95, 99, 102,
 115, 171, 173, 178–186, 191,
 194–196
Generation, 5, 6, 98, 126, 315, 335
Geometry, 12, 30, 102, 111, 128, 246, 248,
 254, 269, 274, 276, 277, 279,
 282, 283, 286–289, 291, 293, 294,
 297–299, 322, 328
Glyphs, 269, 270, 273, 276, 279, 281, 283–288,
 295, 298, 322, 324, 329, 330
Gnoseology, 253
Gnosticism, 19, 23
God, 3, 84, 111, 217, 295, 337, 351
God-less, 36
Gravitational waves, 95, 96, 129, 188, 192
Grundloss, 52, 149

H

Hardware, 223, 304, 307, 309, 313, 314, 317
Harmony, 132, 145, 219, 272, 334
Hegelian, 54–57, 60, 151, 344
Heisenberg's equation, 162
Hellenistic, 7, 15–17
Hilbert space, 160, 162, 167, 173, 280, 325
History
 historical, ix, xii, 2, 17, 19, 29, 39, 47, 48,
 50, 53, 54, 56, 60, 66, 67, 69, 110,
 111, 120, 125, 156, 239–247, 249,
 250, 252–255, 258, 259, 261–263,
 271, 272, 274, 275, 279, 288,
 297–299, 306, 327, 349, 350, 357
 historicism, 241, 242, 251
Holism, holistic, 38
Homeostasis, 134, 210, 213
Human sciences, xiv, 45, 69, 240, 244, 260
Hylomorphism, 14, 27
Hyperrealism, 130
Hypostasis
 hypostatizable, 126
 hypostatization, 39, 41, 68, 122–129, 146,
 353

I

Idealism
 idealist, 39, 51, 57, 130
 material, 51–55
 objective, xii, 46–49, 127, 133, 147
 subjective, 36, 42–46, 49
 transcendental, 40–44, 53, 255
Ideogram, ideograms, 278, 284–296, 298, 299,
 322–324, 329, 330
Ignorabimus, 124
Immaterialism, 36
Impetus, 26
Incommensurability, 129, 230, 241, 287, 336,
 343, 345
Inertia, 26, 170, 171, 178, 180, 182, 186, 187,
 193
Infinite, 10, 11, 29, 32, 34, 50, 52, 97, 121,
 125, 135, 140, 148–150, 156, 182,
 217, 222, 233, 273, 280, 330, 331
Information, 165, 189, 192, 193, 203, 208, 303,
 304, 306–309, 311–313, 317, 326
Interactionism, 211, 219, 220
Interplay, 13, 111, 112, 117, 129–133, 137,
 141, 146, 150, 246, 250, 256, 277,
 340, 353, 357
Intuitionism, 270, 277
Invariance, 179–181, 195–196

- Irreducible, irreducibility, 34, 63, 123, 135, 216, 221, 222, 224, 227, 250–252, 333, 335, 336, 340, 341, 356, 358, 359
- Islamic, 21, 22, 25, 45
- K**
- Kami*, 145, 149
- Kantian, 41–44, 49, 52, 53, 55, 116, 137–139, 252, 255, 293
- Kenosis*, 130
- Knowledge, 2, 80, 111, 163, 200, 218, 240, 270, 317, 326, 336, 349
- Kyoto School of philosophy, 148
- L**
- Language, 28, 54, 64, 101–103, 117, 179, 181, 186, 224, 245, 251, 253, 274, 277, 281, 282, 284–288, 294, 303, 309, 311–314, 316, 322, 324, 325, 327, 328, 330–332, 339, 355
- Law
- derivative, 85–86
 - fundamental, 85–87
 - meta-, 86
 - statement, 85–86
- Lawful, 5, 7, 10, 12, 86, 88, 104, 105
- Level
- macro, 205, 206
 - mesolevel, 205, 206
 - micro, 205, 206, 249, 252
- Life, 13, 20, 32, 34, 37, 39, 55–57, 64, 66, 67, 110, 111, 114, 125, 126, 128, 130, 134, 136, 140, 145, 146, 150, 190, 204, 207–210, 223, 224, 226, 230–232, 250, 252, 256, 274, 284, 307, 352, 358
- Literalism, 17, 18
- Logic, 46, 50, 56, 61, 117, 127, 128, 133, 145, 147, 149, 150, 240, 269–299, 309, 315, 322, 331, 343, 344, 352, 357
- Logos*, 4, 8, 15, 146
- M**
- M_1 , 115, 117–119, 122–125, 127, 129–131, 136, 137, 189
- M_2 , 115, 117–119, 123, 125–127, 129–131, 133, 136, 137, 189
- M_3 , 115, 117–119, 127–131, 133, 136, 137
- Machine, 30, 31, 33, 37, 51, 91, 102, 208, 221, 247, 254, 304–309, 311–314, 317, 330
- Manichean, 298
- Mapamundi*, 112, 119, 120
- Marxist, 56, 60–63, 110, 245
- Mass, 10, 18, 24, 57, 58, 83, 89, 91, 186–189, 248, 254, 256, 257, 308, 357
- Materia*, 21, 25, 29
- Materialism
- animist-friendly, 65–66
 - anti-reductionist, 65
 - Australian, 62, 63, 110, 351
 - Cartesian, 222
 - discontinuous, 36, 66–68, 80, 109–151, 243, 251–256, 351
 - eliminative, 62–65, 110, 123, 131, 145, 221–223, 227, 353
 - exclusive, 60, 250, 353, 354
 - feminist, 351
 - formalist, 276–282, 299, 322, 330, 331
 - inclusive, 2, 50, 53, 59, 61, 66–69, 123, 250, 252, 353, 357–359
 - individualist, 37
 - Marxist, 60–62
 - materiality, 250, 263
 - Marxist, 60–62
 - “New materialism,” 65, 66, 110, 140, 249, 250, 351, 353
 - non-reductive, 222–226
 - philosophical, 2, 10, 12, 13, 30, 31, 36, 38, 39, 41–43, 45, 46, 48, 55, 59, 60, 68, 69, 110, 112, 113, 122, 133, 199, 243, 249, 304, 352, 356
 - reductive, 62–64, 222, 224, 225, 255
 - revisionary, 62–64
 - speculative, 65, 110, 138, 351
 - systemic, 36, 65–68, 79–105, 110, 123, 124, 128, 132, 134, 135, 145, 199–213, 304, 351
 - transcendental, 113
 - vulgar, 61, 62, 67, 122, 123, 133, 275, 353, 354, 358
- Materiality, xiv, 38, 83, 95, 96, 115–119, 124, 129–133, 135–137, 194, 243, 244, 246, 248, 250, 252, 255, 257, 259, 263, 269, 275, 276, 278, 281, 282, 322, 323
- Mathematics, mathematical, 12, 80, 111, 156, 179, 246, 270, 304, 321, 335
- Matter
- biological, 61, 117, 127, 221, 339, 345, 354, 355, 358

- chemical, xiv, 61, 117, 134, 346
 eidetic-abstract matter, 117
 physical, xiii, 31, 60, 63, 65, 68, 114, 117,
 122–125, 129, 130, 133, 215, 217,
 243, 244, 250, 252, 253, 256, 263,
 296, 339, 341, 346, 356, 358
 psychic matter, 117
 social, artificial, 358
 Meaningfulness, 142–145
 Mechanics, xiii, 31, 33, 34, 59, 61, 79, 102,
 155–163, 165, 166, 173, 174, 297
 Mechanisms, 4–8, 11, 31, 33–34, 80, 88–90,
 99, 100, 105, 120, 132, 134, 146,
 149, 192, 201, 203, 204, 207–210,
 225, 226, 228, 234, 252, 262, 284,
 305, 308, 315, 335, 336, 338, 342,
 344, 346, 352
 Medusa Effect, 146, 353, 355
 Megarians, 23, 350
 Memories, x, 32, 64, 117, 118, 123, 126, 129,
 211, 212, 219, 226, 281, 284, 286,
 308–312, 318
 Mental
 activity, 35, 93, 94, 221
 disorder, 94
 Mereology, mereological, 114
 Metabolism, 134, 209, 210, 213
 Metaphysics
 Christian, 23, 39, 49, 57, 125
 hypostatizing, 114, 118, 129, 132, 146,
 295, 353
 Meta-why-question, 148
 Middle Ages, 23–26, 94
 Mind, 10, 81, 125, 157, 183, 199, 215, 246,
 274, 314, 322, 335, 350
 Modes, 40, 82, 168–170, 192, 199, 274, 325,
 339
 Monism, 23, 27, 37, 50, 61, 67, 96–99, 131,
 133, 134, 200, 216, 220–223, 225,
 227, 229, 234, 251, 337, 340, 344,
 345
 Morals, xi, 12, 43, 54, 66, 103, 104, 114, 248
 Mortality, 15, 48
 Motion, 5, 14, 26, 32, 35, 37, 58, 83, 178, 181,
 183, 184, 186, 194, 196, 248, 297
 Multiplicities, 47, 121, 132, 133, 135, 137,
 141, 146, 242, 342, 344
Musubi, 145, 149
 Mystery, 23, 151, 191, 296, 317
 Mythological, 3, 4, 8–11, 14, 17, 18, 21, 24,
 27, 34, 111, 114, 117, 120, 122, 127,
 144–146, 325, 356, 357
- N**
 Naturalism, naturalist, 3–16, 21, 22, 55, 122,
 216, 222, 240, 272
 Nature, 3, 80, 111, 157, 177, 212, 216, 241,
 270, 304, 333, 352
 Necessity, 3, 5, 15, 23, 34, 40, 44, 47–49, 68,
 111, 112, 126, 133, 148, 149, 239,
 243, 248, 254, 255, 260, 261, 271,
 293–297, 328
 Negativity, 21, 26, 44, 47, 66, 357
 Neology, 135
 Neophobia, 22, 135, 337, 342, 346
 Neoplatonism
 Neoplatonic, 16, 18, 19, 21, 22, 24, 25, 49
 Neoplatonist, 22, 26
 Nervous systems, 32, 39, 53, 61, 100, 123, 124,
 126, 129–131, 133, 137, 140, 142,
 143, 151, 211, 212, 219, 221, 222,
 224, 227, 228, 231, 346
 Neuron
 neuro-psychology, 233
 Nihilism, 45, 143, 151
 Nominalism, 100, 127, 271
 Nothingness, 9, 11, 19, 22, 36, 122, 127, 143,
 148
Noumenon, noumena, 41, 42, 46, 51, 255
Nous, 10, 11, 13, 15, 42, 234
 Novelty, 22, 36, 66, 67, 90, 92, 105, 123,
 134–136, 149, 178, 194, 203–205,
 207, 224–227, 288, 307, 335, 337,
 338, 340, 346
 Numbers, xiv, xii, xviii, 5, 11, 12, 25, 35, 38,
 57, 58, 60, 81, 83, 84, 89–91, 100,
 101, 104, 105, 124, 149, 167–170,
 183, 200, 203, 211, 215, 216, 219,
 220, 229, 230, 240, 244, 249, 250,
 254, 270, 271, 273–275, 277, 279,
 281, 283, 285–288, 290, 293–295,
 297, 305–307, 309, 311–315, 318,
 322–326, 328–331, 338
 Numinous, 145
- O**
 Objective
 objectivity, 36, 128, 163, 207, 242, 243
 Objects, 8, 82, 120, 156, 178, 199, 239, 270,
 305, 322, 337, 350
 Oceanography, 239, 243, 244, 254, 256–259,
 261, 262
 Omnipotence, 23, 32, 52
 Omniscience, 23, 125, 132

- Ontogeny, 231
 Ontological-general matter (M), 115, 116,
 119–123, 131, 137, 255
 Ontology
 flat, 136, 139, 249–251, 345
 general, 115, 121, 181, 252, 333
 generating substance, 6–7, 10
 ontological levels, xiii, 90, 91, 124, 135,
 252
 ontological schemes of intersection, 126
 special, 115, 117, 118, 137
 Ontotheology, ontotheological, xiii, 3, 32,
 34, 36, 38, 39, 42–46, 50, 52, 60,
 109, 115, 116, 121, 125, 127, 141,
 143–145, 149, 352, 357
 Operations
 operating subject, 295
 operationalism, 249
 Operators, 161–165, 167–169, 173, 194, 195,
 305, 306, 310, 325, 326, 330
 Organisms, 5, 13, 14, 30, 42, 47, 59, 68, 87, 88,
 91, 99, 102, 103, 117, 123, 126, 129,
 130, 134–136, 139, 204, 208–210,
 220, 221, 223, 224, 226, 228, 229,
 231, 232, 234, 236, 261, 335
- P**
 Paganism, 16
 Pantheism, 23, 38, 46
 Parathetical, 129
 Parts, 13, 80, 109, 178, 201, 224, 258, 272,
 304, 333, 353
 Passivity, 21–22, 26, 44, 47, 66, 357
 Perceptions, 37, 53, 65, 94, 117, 126, 129, 130,
 140, 211, 221, 222, 228, 230, 231,
 245, 255, 260, 304, 350
 Phenomena, 4–6, 8, 9, 11, 15, 27, 29, 31, 36,
 37, 40–42, 44, 45, 51–53, 64, 102,
 123, 155–157, 222, 227, 230, 246,
 249, 250, 252, 253, 255, 288, 305,
 327, 337, 344
 Phenomenalism, 36, 211
 Phenomenology, phenomenological, 50, 59,
 116, 117, 123, 129, 130, 138–142,
 218, 246, 254–256, 263, 356
 Phenomenon, 41, 61, 133, 142, 344
 Philosophical presupposition, 36, 112
 Philosophy
 analytic, 66, 245, 271, 276
 Christian, xiii, 3, 12, 16–18, 21–23, 25, 28,
 30, 34, 37, 39, 42–45, 47–49, 51,
 55, 59, 61, 63, 64, 69, 115, 248
 idealist, xiv, 2, 39, 51, 278, 293
 materialist, xii, xiii, 2, 28, 36, 41, 57, 59,
 109, 110, 113, 116, 119, 127, 147,
 149, 150, 255, 272–276, 278, 293,
 351–353
 pseudo, 38, 62, 63, 111, 143, 147, 352
 Physical
 matter, xiii, 31, 60, 63, 65, 68, 114, 117,
 122–125, 129, 130, 133, 215, 217,
 243, 244, 250, 252, 253, 256, 263,
 296, 339, 341, 346, 356, 358
 pre-, 124, 133
 property, 101, 122, 172, 191, 308, 331, 332
 proto-, 124
 Physicalism, physicalist, xi, ix, 2, 32, 62–67,
 80, 91, 92, 104, 109, 110, 113, 117,
 122–125, 135, 146, 199, 200, 216,
 229, 234, 272, 273, 275, 280–282,
 340, 344, 349, 351, 353, 354, 356
 Physics, 7, 79, 110, 155, 177, 200, 226, 247,
 272, 308, 321, 334, 358
Physis, 3, 24–26
 Platonic, xiii, 8, 13, 16, 18, 21, 22, 25, 49–51,
 111, 119, 127, 132, 146, 150, 220,
 273, 275, 276, 278, 280, 282, 285,
 295, 298, 322, 324, 330, 356, 357
 Platonism, xiii, 15, 16, 18, 25, 26, 127–129,
 269–271, 273–275, 296, 330, 352,
 357
 Plenum, 33, 129, 337
 Pluralism, xiii, 80, 133, 244, 251, 298, 334
 Popper's "Three Worlds," 129
 Populations, 26, 91, 208–210, 228, 260
 Positivism, 56, 110, 240, 245, 255
 Post-Kantian, 116, 137–139
 Power, 5, 12, 27–29, 31, 33, 41, 57, 58, 69, 86,
 87, 90, 102, 132, 139, 166, 218, 261,
 275, 285, 290, 297, 323, 327, 329
Prima materia, 25
 Primordial
 facticity, 48, 148–151
 factum, 148
 ground of reality, 124
 substance, 98
 Probability, 161–164, 174, 221, 228, 242, 298,
 339
 Process, processes, 6, 82, 111, 155, 186, 201,
 217, 241, 271, 305, 327, 334, 351
 Program
 MARIPOSA, 314–316
 Propensity, 161, 163, 164, 166, 174
 Properties, 11, 80, 113, 156, 178, 200, 216,
 245, 271, 308, 322, 334, 352
 Prosopopoeia, 127
 Pseudo

- concept, 352
- Euclidean spacetime, 95
- idea, 38, 143
- philosophy, 111
- problem, 62
- property, 92
- Riemannian metric, 95, 172, 299
- science, 147
- scientific concept, 63
- tensors, 189
- Psyches, 23, 39, 48, 49, 51, 53, 59, 61, 63, 117, 118, 125, 126, 128, 130, 131, 135, 144, 145, 352, 353, 355, 358, 359
- Psychical life, 252
- Psychism, 127, 144, 220, 228
- Psycho
 - biology, 37, 41, 54, 65, 126, 228, 230, 251, 342
 - biosystems, 134, 210–213
 - psychological life, 39, 56, 57, 64, 125, 126, 128, 358
 - psychologism, 39, 125–128, 340
 - psychology, 4, 35, 37, 54, 63–65, 111, 123, 136, 148, 219, 220, 222, 223, 225–230, 232, 233, 240, 251, 341, 342
- Q**
- Qualia*, 32, 64, 123, 127, 130, 131, 134, 216, 221, 222, 226–229
- Qualitative jumps, 56, 207, 337, 344
- Quantifications, 85, 173, 325
- Quantum
 - field theory, xii, 95, 97, 98, 166–171, 187, 191
 - mechanics, xiii, 61, 79, 102, 155–163, 165, 166, 173, 174, 297
 - system, 157–161, 164, 166, 174
- R**
- Radiation, 88, 96, 170, 178, 187–191, 202, 203, 206, 209, 210
- Realism
 - Australian, 62
 - critical, 262
 - naïve, 40, 51, 53, 54, 116, 140, 241, 243
 - speculative, xiii, 39, 138, 140, 145
- Reality, 2, 80, 111, 156, 181, 207, 220, 243, 274, 304, 324, 340, 349
- Reality's muzzle, 142, 150
- Reducible
 - reducibility, 342
 - reduction, 30, 90, 122, 207, 216, 220, 229, 230, 234, 241, 250, 270, 328, 340, 341, 353
- Reductio ab absurdum*, 30, 277
- Reference, xiv, 9, 24, 38, 55, 82, 86, 102, 156, 164, 168–171, 174, 180, 183–185, 188, 189, 207, 209, 221, 225, 228, 233, 243, 247, 248, 251, 253, 254, 271, 274, 278, 281, 304, 305, 321–324, 331, 342
- Relationism, 178, 181–182
- Religion, 3, 8, 9, 13, 15, 16, 38, 42, 45, 47, 54, 68, 125, 145, 275
- Renaissance, 26, 27
- Res cogitans*, 31–33, 50, 218–220, 231
- Res extensa*, 31, 32, 218–220
- S**
- Sacred, 142–145
- Scala Naturae*, 134–137, 336, 345
- Scholastics, xiii, 22, 25, 28, 34, 116, 120, 252, 253, 255, 295, 346, 358
- Schrodinger's equation, 162, 297
- Science
 - demarcation, 260
 - history and philosophy of (HPS), 240–245, 253, 254, 262
 - history of, xiv, 134, 240–263
 - philosophy of, xii, 67, 225, 240, 243–245, 251, 254, 259, 262, 263
 - science wars, 241
 - sociology of, 134, 240
- Scientific Bang, 54, 57–59
- Scientific revolution, 11, 26, 94, 247, 296, 299
- Semiotic, 254, 278, 285
- Set theory, 98, 270, 272, 274, 277, 290, 299, 328, 329
- Shinto, 145, 352
- Signifier, 277–280, 282, 292, 321–323, 330
- Simmel's "Three Kingdoms," 129
- Simplicity, 13, 49, 159, 168, 221, 272
- Skepticism, 16, 36, 40, 41, 112, 113, 132, 217, 232–234
- Software, xiv, 223, 303–318
- Soul, 11–15, 18, 19, 21, 29–32, 34, 37, 38, 40, 41, 50, 64, 123, 125, 217, 295
- Soviet
 - dualism, 61
 - laws, 60
 - leadership, 62
 - Marxist philosophy, 61
 - materialism, 61, 133
 - philosophers, 60, 61, 63

- Union, 60, 62
 - version, 61
 - Space of states, 82, 185
 - Spacetime, ix, xii, 59, 63, 88, 94–96, 98, 99, 105, 118, 119, 124, 135, 166, 168, 170–174, 177–196, 324, 359
 - Species, 5, 29, 55, 121, 130, 140, 205, 207, 213, 275, 330, 351
 - Spiritualism, xi, xii, 29, 31–34, 42, 45, 50–53, 62, 63, 65, 67, 69, 114, 117, 125–127, 133, 134, 145, 344, 352, 356
 - States of affairs, 63
 - Statistics, 247
 - Stoics, 8, 15, 18, 21, 30, 46, 351
 - Stroma*, 118, 133
 - Structuralism, 260, 271
 - Structure, structural, xii, 7, 8, 17, 28, 36–38, 40, 50, 56, 61, 67, 88–91, 93, 99, 101, 104, 105, 111–114, 117–121, 124, 127–130, 132–137, 139–142, 146–151, 160, 165, 170–172, 179–182, 185, 186, 189, 190, 192, 193, 195, 196, 201–204, 207–209, 212, 229, 231, 240, 242, 246, 248, 251–253, 255, 258, 260, 271, 276, 277, 279, 296–298, 304, 305, 307–309, 311–313, 317, 324, 327, 333–335, 340, 341, 345, 346, 352, 355, 357, 358
 - Subject-independent, 35, 36, 46, 61, 116, 128, 141
 - Substance
 - substantialism, 178, 181–183
 - Subsystem, 88, 90, 94, 193, 202, 203, 205, 207, 209, 212, 213, 306, 307
 - Superposition, 158–162, 174
 - Supervenience, 90, 207–208, 337
 - Symbolism, 297
 - Symploké, 13, 112, 117, 121, 131, 132, 146
 - Systemic, xiv, xiii, 36, 65–68, 79–105, 110, 123, 124, 128, 132, 134, 135, 145, 199–213, 223–225, 227, 252, 273, 304–308, 336, 337, 342, 351
- T**
- Tao, 149
 - Technical, 25, 88, 91, 99, 124, 163, 184, 194–196, 205, 245, 270, 299, 304–309, 317, 322, 328, 340
 - Technology, technological, x, xiv, 37, 58, 60, 68, 69, 111, 124, 130, 144, 201, 241, 244–246, 248, 250, 254, 257–259, 261, 262, 303, 304, 306–309, 311, 313, 317, 329, 335, 346, 358
 - Teoría del Cierre Categorial*, 67, 111, 118
 - Thermodynamics, 33, 54, 57, 58, 83, 96, 187–191, 209, 219, 247, 248, 254, 263, 357
 - Thing-in-itself, 40, 41, 52
 - Things, 2, 82, 111, 156, 177, 199, 218, 247, 273, 306, 324, 335, 350
 - Topology, 88, 118, 128, 276, 277, 286, 290, 322, 324
 - Transcendental
 - consciousness, 39–42, 44, 45, 51, 119, 125
 - ego, 49, 53, 115, 116, 119–121, 139, 241
 - idealism, 40–44, 53, 119, 255
 - materialism, 110, 351
 - Translation, 27, 38, 113, 123, 130, 131, 150
 - Trope, 8
 - Truth, 7, 11, 16, 22, 30, 32, 37, 50, 52, 68, 69, 111, 112, 120, 123, 127, 128, 143, 144, 240, 241, 243, 244, 248, 249, 251, 254, 255, 258, 259, 262, 263, 270, 271, 274, 299, 326, 327, 352, 356
 - Typology, 131, 132
- U**
- Ultimate steresis, 151
 - Universe
 - universal, 8, 25, 27, 29, 33, 36, 47–49, 54, 58, 59, 82, 85, 97, 98, 103, 118, 128, 171, 225, 273, 295, 296, 308, 334–336, 338, 339, 345, 346
 - Unknown ontological processes, 68, 358
- V**
- Vacuum, 33, 96, 166–168, 170–172, 174, 181, 184, 191, 232
 - Values, 8, 97, 142, 159, 179, 227, 242, 291, 306, 324, 356
 - Vienna Circle, 62, 245
 - Vitalism, 207–209
- W**
- Wave function, 160–163, 325
 - Will, 51–53, 147

Wissenschaft, 38, 43, 54

World

macrophysical, 124, 134

microphysical, 124, 130, 134

worldview, xi, xii, 2–6, 8, 10–12, 16, 17,
24, 26, 32, 34, 38, 43, 54–56, 58,
59, 61, 81, 110, 116, 117, 144, 145,
151, 222, 241, 242, 245, 336, 351,
352, 354, 357

Y

Yūgen, 141, 150

Z

Zoological argument against idealism, 130

Zoroastrian, 18